



60 ANNI DI TRADIZIONE ITALIANA

Luxor è una importante realtà industriale, market leader a livello europeo e mondiale nella produzione di tubi flessibili e di componenti per impianti idraulici e termosanitari.

Da sessant'anni Luxor è espressione del più prestigioso made in Italy e della grande tradizione italiana nelle lavorazioni meccaniche ad elevato contenuto tecnologico: una qualità certificata e riconosciuta dai più prestigiosi Istituti Internazionali di certificazione, ovunque nel mondo.

La nostra mission è la completa soddisfazione del cliente, mediante un processo di continua ricerca tecnologica volta a realizzare prodotti di assoluta qualità e totale affidabilità, anticipando le evoluzioni dei mercati all'interno di un innovativo rapporto di partnership sia verso i clienti che verso i fornitori. La mission Luxor trova attuazione in un proprio Centro Ricerca & Sviluppo, nel quale vengono costantemente analizzate e ricercate nuove ed avanzate tecnologie, in continui investimenti per offrire ai mercati internazionali le soluzioni più avanzate ed affidabili a costi contenuti, nei più severi controlli qualitativi su ogni pezzo.

Luxor progetta e realizza globalmente, grazie al proprio ultra decennale know-how, ogni prodotto. La grande forza produttiva, un'organizzazione industriale "snella" innovativa ed avanzata, unitamente ad una moderna concezione logistica permettono a Luxor di soddisfare qualsiasi esigenza, anche customized, con consegne rapide in ogni parte del mondo.



Luxor S.p.A. è certificata ISO 9001:2015 dall'istituto di certificazione DEKRA Group

CERTIFICAZIONI



Per informazioni sulle specifiche tecniche e sui prodotti certificati si prega di rivolgersi ai nostri uffici o visitare il sito web degli enti di certificazione corrispondenti.

La lista completa dei prodotti certificati NSF è consultabile al sito www.nsf.org.

La lista completa dei prodotti certificati UPC/cUPC è consultabile al sito www.iapmort.org.

1 VALVOLE RADIATORE

1.1 / EASY

Valvole e Detentori



Attacco tubo ferro

10



Attacco tubo rame e tubo plastica W24x19

12



Attacco tubo rame e tubo plastica G3/4 eurocono

14

1.2 / THERMOTEKNA

Valvole e Teste Termostatiche



Kit termostatici: attacco tubo ferro

24



Kit termostatici: attacco tubo rame e tubo plastica W24x19

25



Kit termostatici: attacco tubo rame e tubo plastica G3/4 eurocono

26



Attacco tubo ferro

27



Attacco tubo rame e tubo plastica W24x19

30



Attacco tubo rame e tubo plastica G3/4 eurocono

33



Teste Termostatiche

40

1.3 / SERIE 30

Valvole



Valvole per radiatore

53

1.4 / SERIE 50th

Valvole per radiatore



Kit termostatici: attacco tubo rame e tubo plastica G3/4 eurocono

62



Kit manuali: attacco tubo rame e tubo plastica G3/4 eurocono

65



Valvole termostattizzabili con prerogolazione

67



Valvole manuali: attacco tubo rame e tubo plastica G3/4 eurocono

70



Valvole monotubo bitubo

72



Testa termostatica con comando e sensore incorporato

73

1.5 / M-MT

Valvole e distributori



Valvole manuali a 4 vie per impianti monotubo

81



Valvole termostatiche a 4 vie per impianti monotubo

85



Valvole per impianti monotubo e bitubo

88



Distributori a 4 vie per impianti monotubo e bitubo

94



Valvole coassiali

99



Distributori per impianti monotubo e bitubo per corpi scaldanti

101

1.A / ACCESSORI



Accessori per valvole, detentori, valvole a 4 vie e distributori

106

2 COLLETTORI

2.1 / SERIE CP

Collettori semplici



Collettori semplici componibili

113



Collettori semplici componibili con valvole di intercettazione

120



Collettori semplici componibili con filetti in fase e valvole di intercettazione

127

2.2 / SERIE CC

Collettori complanari



Collettori complanari

134

2.3 / SERIE CD

Collettori di distribuzione



Collettori di distribuzione per impianti di riscaldamento

141



Collettori di distribuzione premontati con accessori di installazione

164

2.4 / SERIE CX

Collettori di distribuzione in acciaio inox



Collettori di distribuzione in acciaio inox

180



Valvola a sfera multifunzione

185

2.A / ACCESSORI



Teste termostatiche

190



Accessori per collettori di distribuzione

191

3 VALVOLE



Valvole a sfera

212



Valvole bypass per impianti riscaldamento

217



Valvole di scarico aria

218



Valvole di sicurezza

221



Valvola miscelatrice termostatica e valvole deviatrici di zona

223



Defangatore magnetico per impianti di riscaldamento

229

4 GRUPPI PREMONTATI



Sistemi di regolazione per impianti a pannelli radianti con il gruppo pompa GP 1190

234



Sistemi di regolazione con il gruppo pompa GP 1190 e kit per alta temperatura KA 1191

239



Sistemi di regolazione con il gruppo pompa GP 1190 e kit per alta temperatura FM 750

245



Sistemi di regolazione per impianti a pannelli radianti con il gruppo di miscela GM 1192

250



Gruppi pompa per solare

256

5 ACCESSORI ELETTRICI ED ELETTRONICI



Teste termoelettriche

267



Termostati di sicurezza a contatto e ad immersione

274



Pompa di circolazione

278



Centraline di termoregolazione elettroniche di tipo climatico

279



Servomotori

282



Azionatore per la regolazione temperatura ambiente

285

6 SISTEMA IDRONICO MODULARE



Collettori

294



Gruppo di rilancio

296



Gruppo a punto fisso

298



Gruppo a punto scorrevole

300



Accessori collettori di distribuzione

304



Coibentazione

305

7 RACCORDI



Raccordi per tubo rame

311



Raccordi per tubo in polietilene, polibutene e polipropilene

312



Raccordi per tubo in polietilene multistrato PEX-AL-PEX

313



Raccordi a stringere cromati

314



Raccordi sottotraccia per la distribuzione con tubi sfilabili

318



Raccordi per tubi in rame, plastica e multistrato

319

1 TUBI FLESSIBILI BAGNO

**1.1 / FLEXY MIX**
DN 8 EPDM miscelatore

345

**1.2 / FLEXY MIX PT+**
DN 8 Silicone miscelatore

349

**1.3 / OMNYFLEX 8**
DN 8 EPDM generico

353

**1.4 / OMNYFLEX PT+**
DN 8 Silicone generico

363

**1.5 / OMNYFLEX 10**
DN 10 EPDM generico

369

**1.6 / W-FLEX**
DN 8-10 EPDM doccia /
idromassaggio

379

**1.7 / SHOWER FLEX**
DN 10 PVC doccia

383

**1.8 / OMNYFLEX 13**
DN 13 EPDM generico

387

2 TUBI FLESSIBILI CUCINA

**2.1 / K-FLEX**
DN8 EPDM doccetta cucina

393

**2.2 / FLEXY MIX**
DN 8 EPDM miscelatore

397

**2.3 / FLEXY MIX PT+**
DN 8 Silicone miscelatore

401

3 TUBI FLESSIBILI CARICO ELETTRODOMESTICI

**3.1 / E-FLEX INOX**
DN 8-10-13 con treccia

405

**3.2 / E-FLEX**
DN 10 senza treccia

409

4 TUBI FLESSIBILI INDUSTRIALI

**4.1 / ACFZ-S**
DN 15-50 acciaio zincato

413

**4.2 / ACFZ-B**
DN 15-50 raccordi ottone

421

**4.3 / ACFX**
DN 15-50 acciaio inox

429

**4.4 / ACEX**
DN 15 - 25 estensibile

437

Tubi flessibili:
istruzioni di installazione

438

Tubi flessibili:
istruzioni di manutenzione

439

Tubi flessibili:
istruzioni di lunghezza

440

5 COLLEGAMENTI RIGIDI SOTTOLAVABO



Istruzioni di
installazione

443



Tubetti rame cromato

444



Squadrette
sottolavabo

447



Raccordi a
compressione

450



Rosette

451

6 RUBINETTI



6.1 / STARX
Rubinetti a vitone
con filtro

457



6.2 / DELTAX
Rubinetti a vitone
senza filtro

463



6.3 / SPHERALUX
Rubinetti sottolavabo
a sfera

467



6.4 / SERIE 50th
Rubinetti sottolavabo
d'arredo

473



6.5 / SERIE SC
Rubinetti per cassetta
scarico

477



6.6 / SERIE K
Rubinetti per
elettrodomestici

481



6.7 / ACCESSORI

486

7 SIFONI



7.1 / SERIE ST
Sifoni standard

495



**7.2 / SERIE
PREMIUM**
Sifoni di lusso

499



7.3 / SERIE PL
Sifoni in ABS

503



7.4 / SERIE 50th
Sifoni d'arredo

507



7.5 / SERIE K
Sifoni per
elettrodomestici

510



**7.6 / TUBI DI
SCARICO E
ACCESSORI**

512

8 ACCESSORI



Pilette

521



Accessori

523



Nipplo

525



VALVOLE RADIATORE

1.1 / EASY

EASY

VALVOLE E DETENTORI

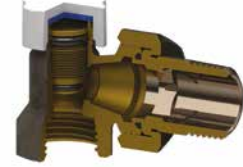

La tenuta in chiusura con l'otturatore è assicurata da un o-ring e da una tenuta conica metallica. Le valvole sono prodotte con finitura nichelata. L'apertura delle valvole e detentori deve essere effettuata con pressione differenziale inferiore a un 1 bar.

La tenuta in chiusura con l'otturatore è assicurata da un o-ring e da una tenuta conica metallica. I detentori sono prodotti con finitura nichelata. Tutti i detentori hanno la possibilità di regolare la portata limitando l'alzata dell'otturatore.

CARATTERISTICHE TECNICHE



DN

10
15
20



Max temperatura

120 °C



Max pressione

10 bar



Max pressione differenziale

1 bar



Materiale

CW617N
UNI EN
12165:2016



Manopola

ABS bianco
RAL 9016



Collaudo

100%

ATTACCHI IMPIANTO



Tubo ferro

G 3/8
G 1/2
G 3/4

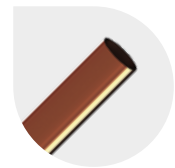

Tubo rame

W 24x19 - TR 91
G 3/4 EK - TR 91/A



Tubo plastica

W 24x19 - TP 95
G 3/4 EK - TP 98



Tubo multistrato

W 24x19 - TP 97
G 3/4 EK - TP 99

COLLEGAMENTO RADIATORE



filetto conico zigrinato

G 3/8
G 1/2
G 3/4



filetto cilindrico con tenuta morbida

G 3/8
G 1/2
G 3/4

VANTAGGI DELL'ASTA REALIZZATA IN DUE PEZZI

La valvola Easy utilizza un'asta fissa la cui tenuta è garantita da due o-rings.

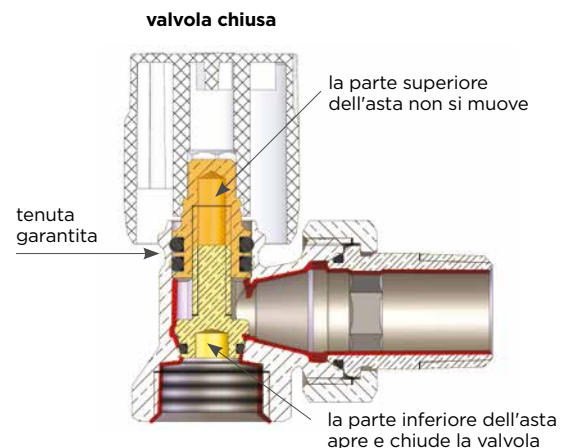
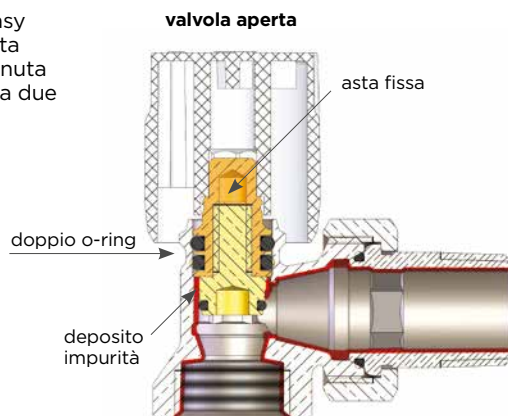

Tutte le valvole e i detentori vengono testati al 100% con prova di tenuta pneumatica a controllo elettronico.

Le caratteristiche del fluido dell'impianto devono essere conformi alla direttiva UNI 8065:2019.

CONFRONTO DEI VANTAGGI DELL'ASTA REALIZZATA IN DUE PEZZI

ASTA IN DUE PEZZI

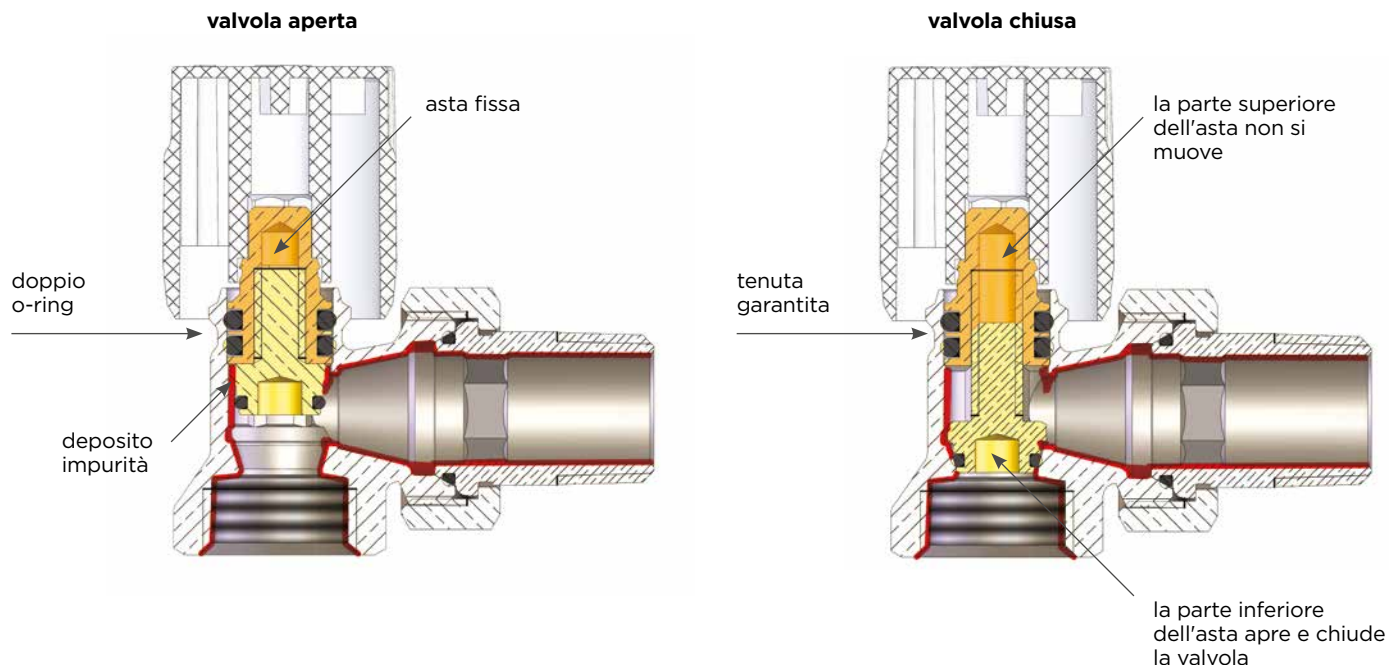

ASTA IN UN PEZZO

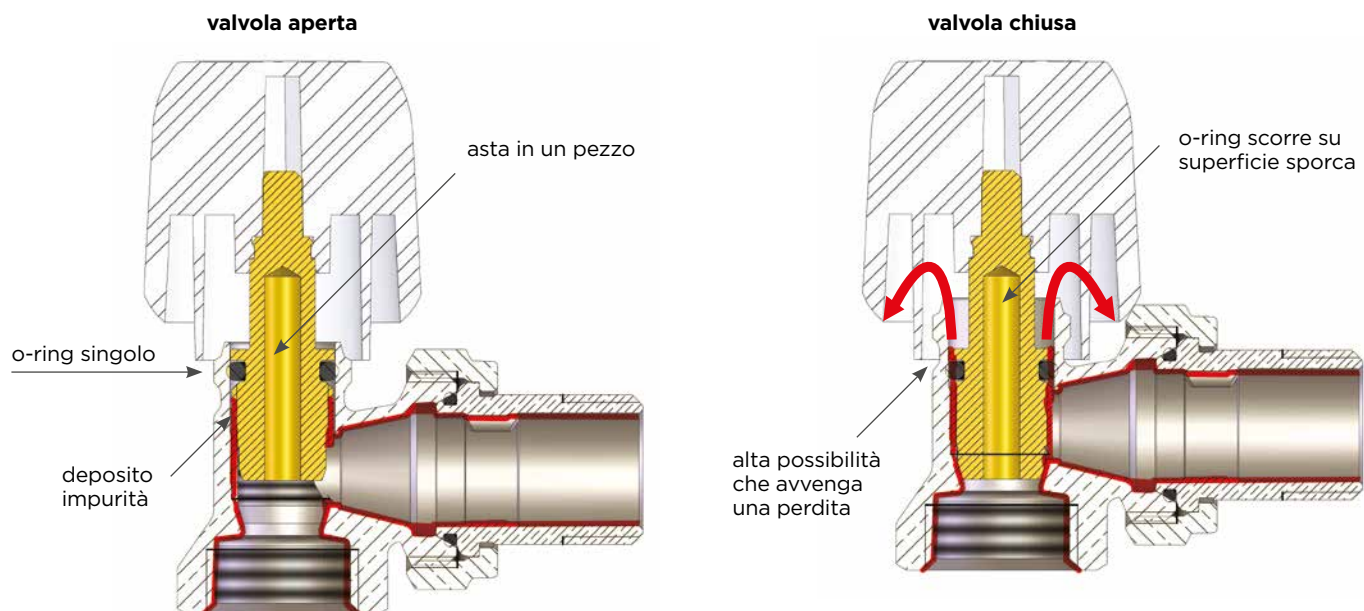

I vantaggi dell'asta realizzata in due pezzi sono molteplici e si verificano sia con la valvola aperta sia con la valvola chiusa.

L'asta fissa, con doppio o-ring, garantisce la tenuta ed evita alle impurità di depositarsi nella sede dove queste guarnizioni lavorano evitando la diminuzione della loro efficacia.

Nell'asta mobile, invece, questo notevole vantaggio non è garantito in quanto la superficie di lavoro delle guarnizioni è esposta alle impurità presenti nel fluido dell'impianto. Questo può aumentare notevolmente la possibilità che avvenga una perdita soprattutto nel medio-lungo periodo.

ATTACCO TUBO FERRO

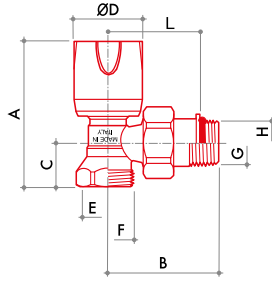

RS 102

Valvola radiatore a squadra a semplice regolazione. Attacco tubo ferro.

Raccordi



CODICE	MISURA	A	B	C	D	E	F	G	H	L			
11021700	DN 10 3/8	65	49	18	32	G 3/8	-	R 3/8	-	-	137	10	80
11022100	DN 15 1/2	67	51	20	32	G 1/2	-	R 1/2	-	-	170	10	80
11022700	DN 20 3/4	70	61	25	32	G 3/4	-	R 3/4	-	-	254	8	64

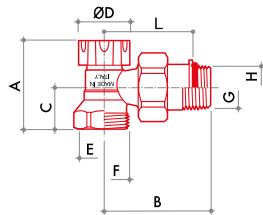

DS 122

Detentore di regolazione a squadra. Attacco tubo ferro.

Raccordi



CODICE	MISURA	A	B	C	D	E	F	G	H	L			
11061700	DN 10 3/8	40	49	18	25	G 3/8	-	R 3/8	-	-	121	10	80
11062100	DN 15 1/2	42	51	20	25	G 1/2	-	R 1/2	-	-	154	10	80
11062700	DN 20 3/4	47	61	25	25	G 3/4	-	R 3/4	-	-	238	8	64

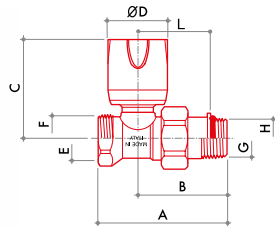

RD 101

Valvola radiatore diritta a semplice regolazione. Attacco tubo ferro.

Raccordi



CODICE	MISURA	A	B	C	D	E	F	G	H	L			
11221700	DN 10 3/8	65	45	53	32	G 3/8	-	R 3/8	-	-	142	10	80
11222100	DN 15 1/2	68	47	53	32	G 1/2	-	R 1/2	-	-	176	10	80
11222700	DN 20 3/4	80	56	55	32	G 3/4	-	R 3/4	-	-	265	8	64

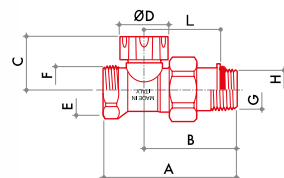

DD 121

Detentore di regolazione diritto. Attacco tubo ferro.

Raccordi

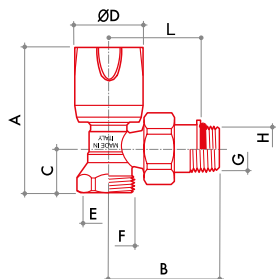

CODICE	MISURA	A	B	C	D	E	F	G	H	L			
11261700	DN 10 3/8	65	45	28	25	G 3/8	-	R 3/8	-	-	132	10	80
11262100	DN 15 1/2	68	47	28	25	G 1/2	-	R 1/2	-	-	161	10	80
11262700	DN 20 3/4	80	56	29	25	G 3/4	-	R 3/4	-	-	248	8	64

**RS 106**

Valvola radiatore a squadra a semplice regolazione. Attacco tubo ferro.

Raccordi

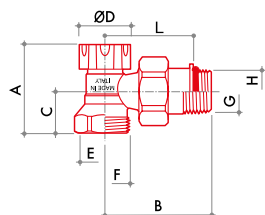

CODICE	MISURA	A	B	C	D	E	F	G	H	L			
11022117	DN 10 3/8	65	46	18	32	G 3/8	-	-	G 3/8	36	143	10	80
11022103	DN 15 1/2	65	47	20	32	G 1/2	-	-	G 1/2	37	174	10	80
11022703	DN 20 3/4	70	58	25	32	G 3/4	-	-	G 3/4	46	257	8	64

**DS 126**

Detentore di regolazione a squadra. Attacco tubo ferro.

Raccordi

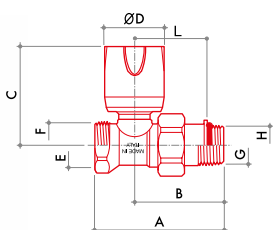

CODICE	MISURA	A	B	C	D	E	F	G	H	L			
11062117	DN 10 3/8	40	46	18	25	G 3/8	-	-	G 3/8	36	127	10	80
11062103	DN 15 1/2	42	47	20	25	G 1/2	-	-	G 1/2	37	158	10	80
11062703	DN 20 3/4	47	59	25	25	G 3/4	-	-	G 3/4	47	241	8	64

**RD 105**

Valvola radiatore diritta a semplice regolazione. Attacco tubo ferro.

Raccordi

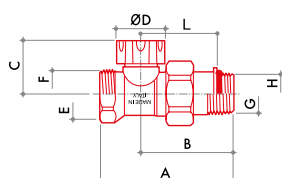

CODICE	MISURA	A	B	C	D	E	F	G	H	L			
11222117	DN 10 3/8	62	42	53	32	G 3/8	-	-	G 3/8	32	148	10	80
11222103	DN 15 1/2	64	43	53	32	G 1/2	-	-	G 1/2	33	180	10	80
11222703	DN 20 3/4	77	53	55	32	G 3/4	-	-	G 3/4	41	268	8	64

**DD 125**

Detentore di regolazione diritto. Attacco tubo ferro.

Raccordi



CODICE	MISURA	A	B	C	D	E	F	G	H	L			
11262117	DN 10 3/8	62	42	28	25	G 3/8	-	-	G 3/8	32	138	10	80
11262103	DN 15 1/2	64	43	28	25	G 1/2	-	-	G 1/2	33	165	10	80
11262703	DN 20 3/4	78	54	29	35	G 3/4	-	-	G 3/4	42	251	8	64



Raccordi per tubo rame



Raccordi per tubo plastica



Raccordi per tubo multistrato



Raccordi: capitolo 7



Accessori: capitolo 1.A

ATTACCO TUBO RAME E TUBO PLASTICA W24x19

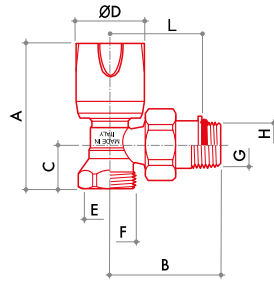

RS 112

Valvola radiatore a squadra a semplice regolazione. Attacco tubo rame e tubo plastica.

Raccordi



CODICE	MISURA	A	B	C	D	E	F	G	H	L			
11121700	DN 10 3/8	67	49	20	32	-	W24x19	R 3/8	-	-	138	10	80
11122100	DN 15 1/2	66	51	20	32	-	W24x19	R 1/2	-	-	159	10	80

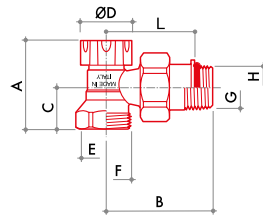

DS 132

Detentore di regolazione a squadra. Attacco tubo rame e tubo plastica.

Raccordi



CODICE	MISURA	A	B	C	D	E	F	G	H	L			
11161700	DN 10 3/8	42	49	20	25	-	W24x19	R 3/8	-	-	122	10	80
11162100	DN 15 1/2	42	51	20	25	-	W24x19	R 1/2	-	-	143	10	80

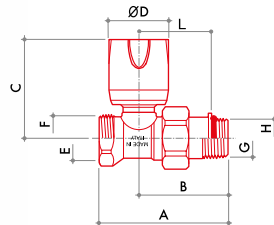

RD 111

Valvola radiatore diritta a semplice regolazione. Attacco tubo rame e tubo plastica.

Raccordi



CODICE	MISURA	A	B	C	D	E	F	G	H	L			
11321700	DN 10 3/8	65	45	53	32	-	W24x19	R 3/8	-	-	144	10	80
11322100	DN 15 1/2	68	47	53	32	-	W24x19	R 1/2	-	-	165	10	80

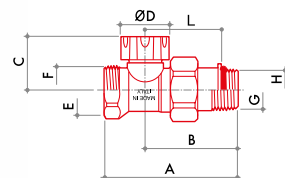

DD 131

Detentore di regolazione diritta. Attacco tubo rame e tubo plastica.

Raccordi



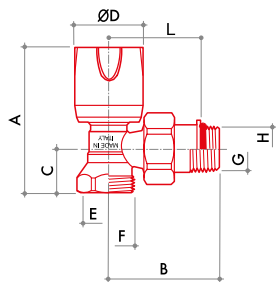

CODICE	MISURA	A	B	C	D	E	F	G	H	L			
11361700	DN 10 3/8	65	45	28	25	-	W24x19	R 3/8	-	-	133	10	80
11362100	DN 15 1/2	68	47	27	25	-	W24x19	R 1/2	-	-	150	10	80

**RS 119**

Valvola radiatore a squadra a semplice regolazione. Attacco tubo rame e tubo plastica.

Raccordi



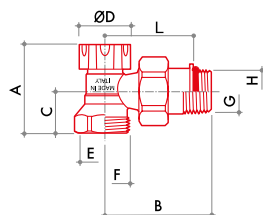

CODICE	MISURA	A	B	C	D	E	F	G	H	L			
11122117	DN 10 3/8	67	46	20	32	-	W24x19	-	G 3/8	36	148	10	80
11122103	DN 15 1/2	66	47	20	32	-	W24x19	-	G 1/2	37	162	10	80

**DS 139**

Detentore di regolazione a squadra. Attacco tubo rame e tubo plastica.

Raccordi



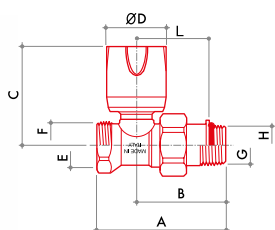

CODICE	MISURA	A	B	C	D	E	F	G	H	L			
11162117	DN 10 3/8	42	46	20	25	-	W24x19	-	G 3/8	36	132	10	80
11162103	DN 15 1/2	42	47	20	25	-	W24x19	-	G 1/2	37	145	10	80

**RD 118**

Valvola radiatore diritta a semplice regolazione. Attacco tubo rame e tubo plastica.

Raccordi



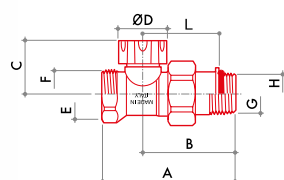

CODICE	MISURA	A	B	C	D	E	F	G	H	L			
11322117	DN 10 3/8	63	42	53	32	-	W24x19	-	G 3/8	32	152	10	80
11322103	DN 15 1/2	64	43	53	32	-	W24x19	-	G 1/2	33	171	10	80

**DD 138**

Detentore di regolazione diritto. Attacco tubo rame e tubo plastica.

Raccordi



CODICE	MISURA	A	B	C	D	E	F	G	H	L			
11362117	DN 10 3/8	63	42	28	25	-	W24x19	-	G 3/8	32	142	10	80
11362103	DN 15 1/2	64	43	27	25	-	W24x19	-	G 1/2	33	161	10	80



Raccordi per tubo rame



Raccordi per tubo plastica



Raccordi per tubo multistrato



Raccordi: capitolo 7



Accessori: capitolo 1.A

ATTACCO TUBO RAME E TUBO PLASTICA G3/4 EUROCONO

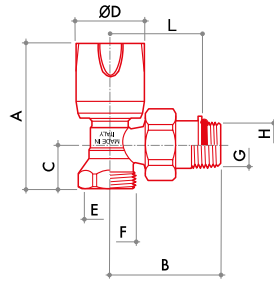

RS 112/A

Valvola radiatore a squadra a semplice regolazione. Attacco tipo eurocono.

Raccordi



CODICE	MISURA	A	B	C	D	E	F	G	H	L			
11122718	DN 10 3/8	65	49	20	32	-	G 3/4 EK	R 3/8	-	-	148	10	80
11122721	DN 15 1/2	66	51	20	32	-	G 3/4 EK	R 1/2	-	-	161	10	80

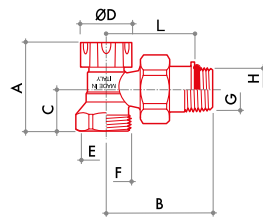

DS 132/A

Detentore di regolazione a squadra. Attacco tipo eurocono.

Raccordi



CODICE	MISURA	A	B	C	D	E	F	G	H	L			
11162718	DN 10 3/8	42	49	20	25	-	G 3/4 EK	R 3/8	-	-	130	10	80
11162721	DN 15 1/2	42	51	20	25	-	G 3/4 EK	R 1/2	-	-	144	10	80

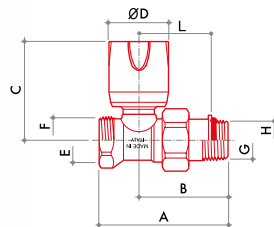

RD 111/A

Valvola radiatore diretta a semplice regolazione. Attacco tipo eurocono.

Raccordi



CODICE	MISURA	A	B	C	D	E	F	G	H	L			
11322719	DN 10 3/8	66	45	53	32	-	G 3/4 EK	R 3/8	-	-	149	10	80
11322722	DN 15 1/2	69	48	53	32	-	G 3/4 EK	R 1/2	-	-	170	10	80

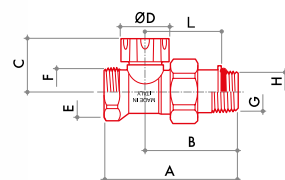

DD 131/A

Detentore di regolazione diretto. Attacco tipo eurocono.

Raccordi

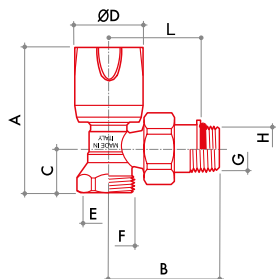

CODICE	MISURA	A	B	C	D	E	F	G	H	L			
11362719	DN 10 3/8	66	45	28	25	-	G 3/4 EK	R 3/8	-	-	138	10	80
11362722	DN 15 1/2	69	48	28	25	-	G 3/4 EK	R 1/2	-	-	160	10	80

**RS 119/A**

Valvola radiatore a squadra a semplice regolazione. Attacco tipo eurocono.

Raccordi

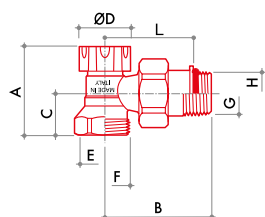

CODICE	MISURA	A	B	C	D	E	F	G	H	L			
11122717	DN 10 3/8	66	46	20	32	-	G 3/4 EK	-	G 3/8	36	151	10	80
11122703	DN 15 1/2	66	47	20	32	-	G 3/4 EK	-	G 1/2	37	165	10	80

**DS 139/A**

Detentore di regolazione a squadra. Attacco tipo eurocono.

Raccordi

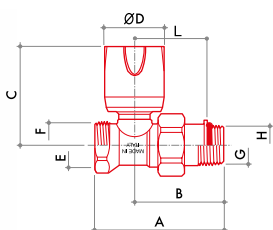

CODICE	MISURA	A	B	C	D	E	F	G	H	L			
11162717	DN 10 3/8	42	46	20	25	-	G 3/4 EK	-	G 3/8	36	135	10	80
11162703	DN 15 1/2	42	47	20	25	-	G 3/4 EK	-	G 1/2	37	148	10	80

**RD 118/A**

Valvola radiatore diritta a semplice regolazione. Attacco tipo eurocono.

Raccordi

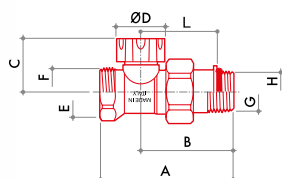

CODICE	MISURA	A	B	C	D	E	F	G	H	L			
11322717	DN 10 3/8	63	42	53	32	-	G 3/4 EK	-	G 3/8	32	155	10	80
11322703	DN 15 1/2	64	43	53	32	-	G 3/4 EK	-	G 1/2	33	174	10	80

**DD 138/A**

Detentore di regolazione diritto. Attacco tipo eurocono.

Raccordi



CODICE	MISURA	A	B	C	D	E	F	G	H	L			
11362717	DN 10 3/8	63	42	28	25	-	G 3/4 EK	-	G 3/8	32	145	10	80
11362703	DN 15 1/2	64	43	27	25	-	G 3/4 EK	-	G 1/2	33	164	10	80



Raccordi per tubo rame



Raccordi per tubo plastica



Raccordi per tubo multistrato



Raccordi: capitolo 7



Accessori: capitolo 1.A

DIAGRAMMA DI PORTATA VALVOLE

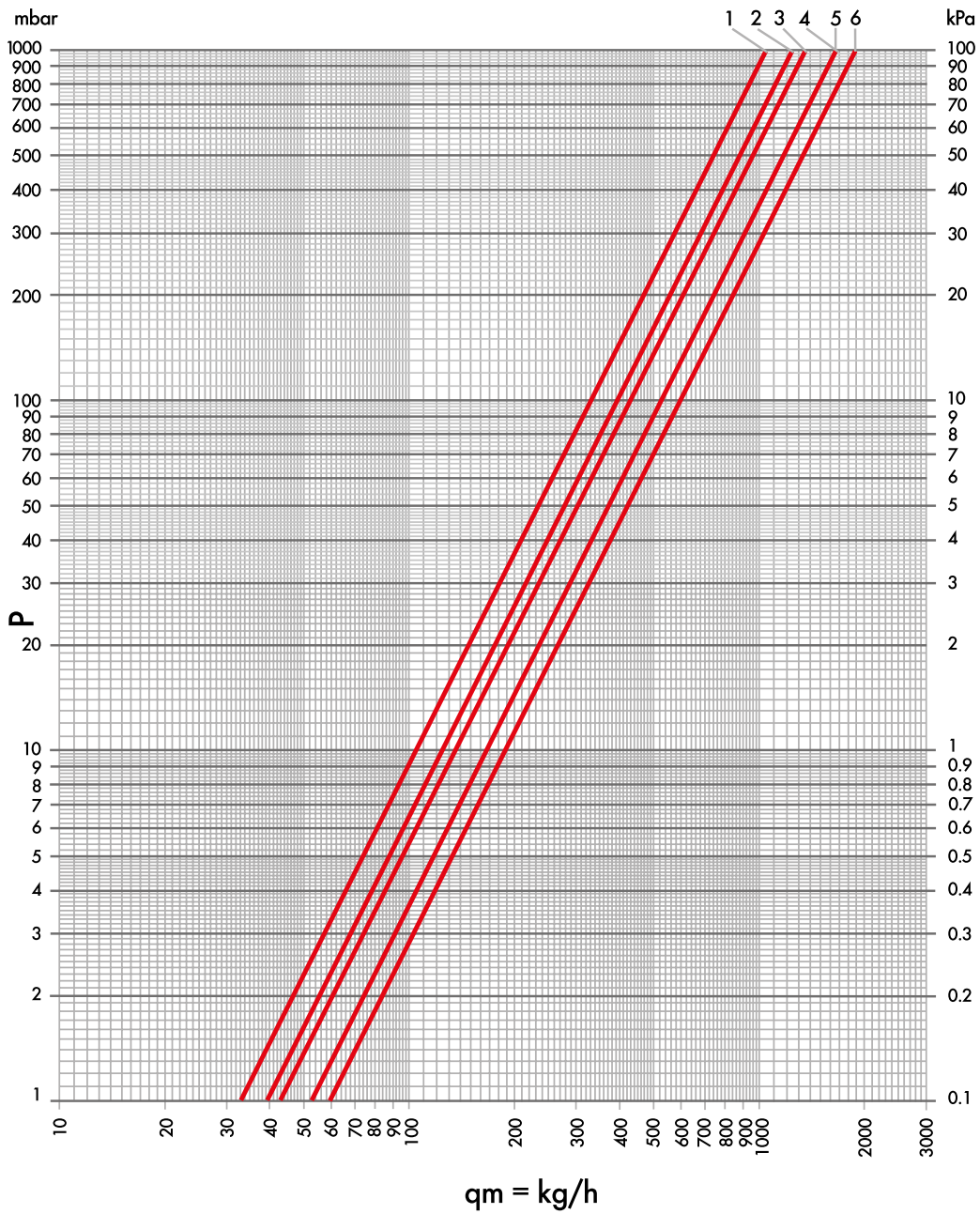

ARTICOLI	Kv	POS
RD 101 3/8 - RD 105 3/8 - RD 111 3/8 RD 118 3/8 - RD 118/A 3/8	1.05	1
RD 101 1/2 - RD 105 1/2 - RD 111 1/2 RD 111/A 1/2 - RD 118 1/2 - RD 118/A 1/2	1.25	2
RD 101 3/4 - RD 105 3/4	1.35	3
RS 102 3/8 - RS 106 3/8 - RS 112 3/8 RS 119 3/8 - RS 119/A 3/8	1.65	4
RS 102 1/2 - RS 106 1/2 - RS 112 1/2 RS 112/A 1/2 - RS 119 1/2 - RS 119/A 1/2	1.65	5
RS 102 3/4 - RS 106 3/4	1.90	6

DIAGRAMMI DI PORTATA DETENTORE

DETENTORE A SQUADRA

DN 10 3/8 - DN 15 1/2

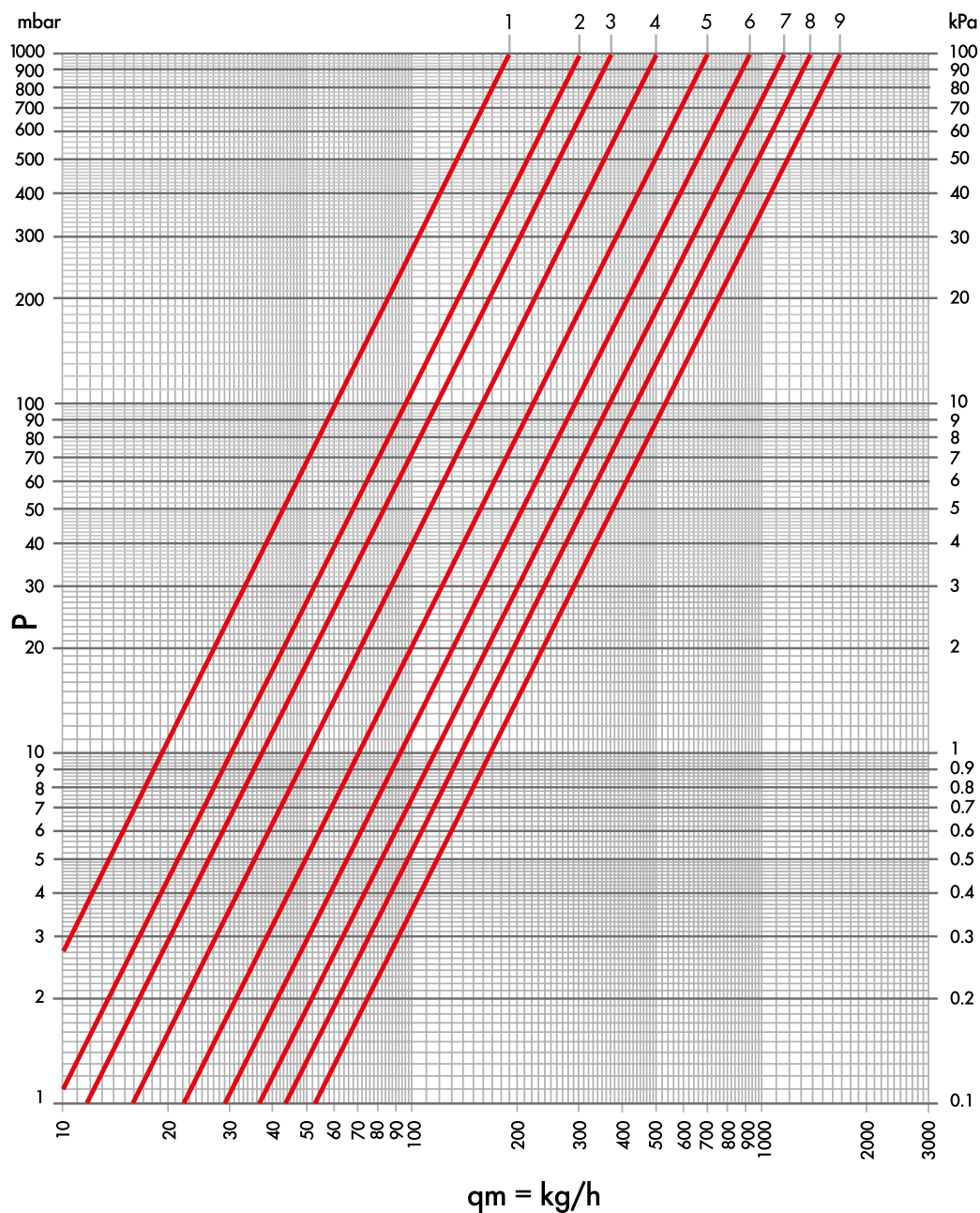

ARTICOLI	N. GIRI	Kvs	POS
DS 122 DS 126 DS 132 DS 139 DS 132/A DS 139/A	1	0.19	1
	1+1/2	0.30	2
	2	0.37	3
	2+1/2	0.50	4
	3	0.69	5
	3+1/2	0.92	6
	4	1.14	7
	4+1/2	1.39	8
	tutto aperto	1.65	9

DIAGRAMMI DI PORTATA DETENTORE

DETENTORE A SQUADRA

DN 20 3/4

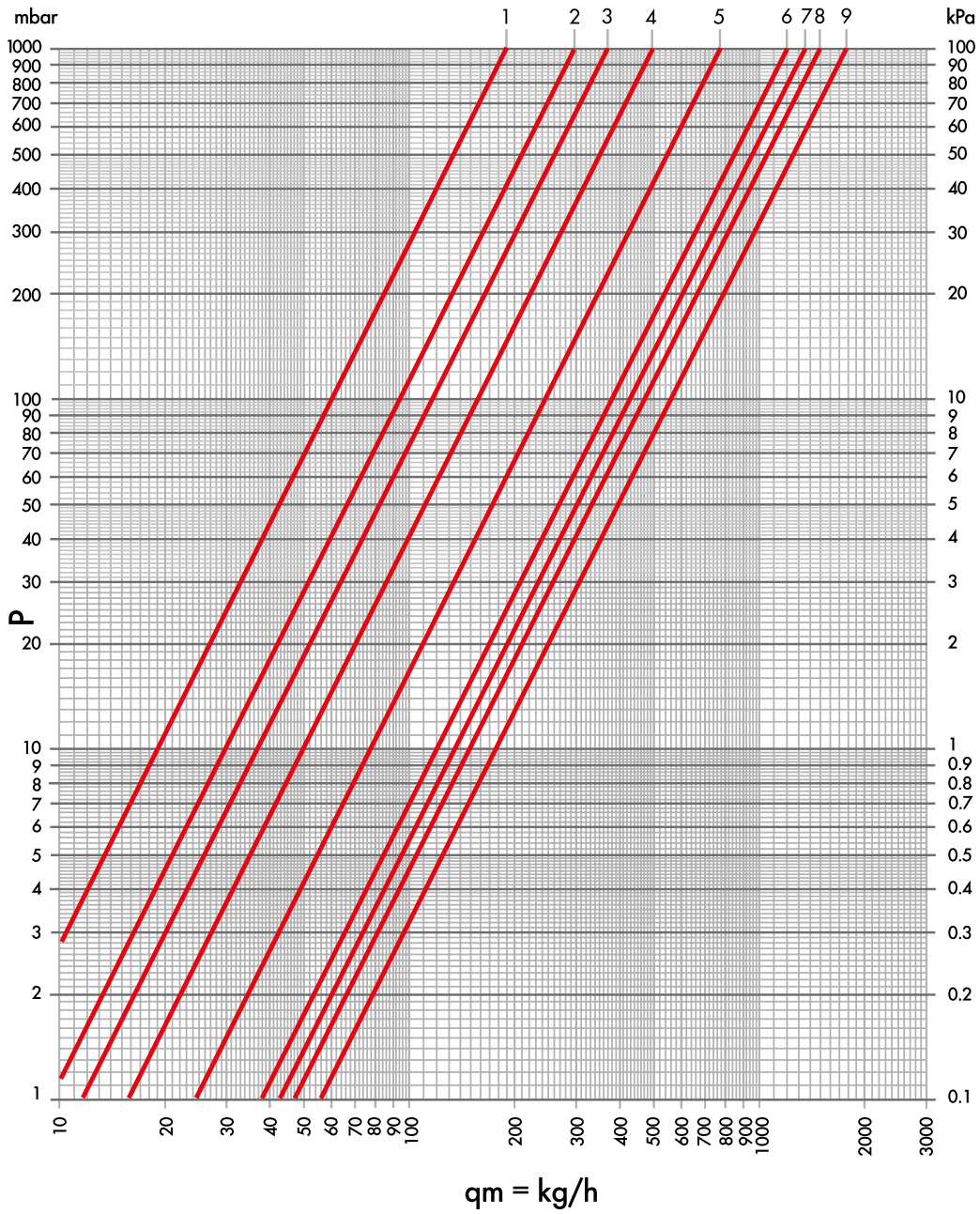

ARTICOLI	N. GIRI	Kvs	POS
DS 122 DS 126 DS 132 DS 139 DS 132/A DS 139/A	1	0.19	1
	1+1/2	0.30	2
	2	0.37	3
	2+1/2	0.50	4
	3	0.78	5
	3+1/2	1.19	6
	4	1.34	7
	4+1/2	1.50	8
	tutto aperto	1.75	9

DIAGRAMMI DI PORTATA DETENTORE

DETENTORE DIRITTO

DN 10 3/8 - DN 15 1/2

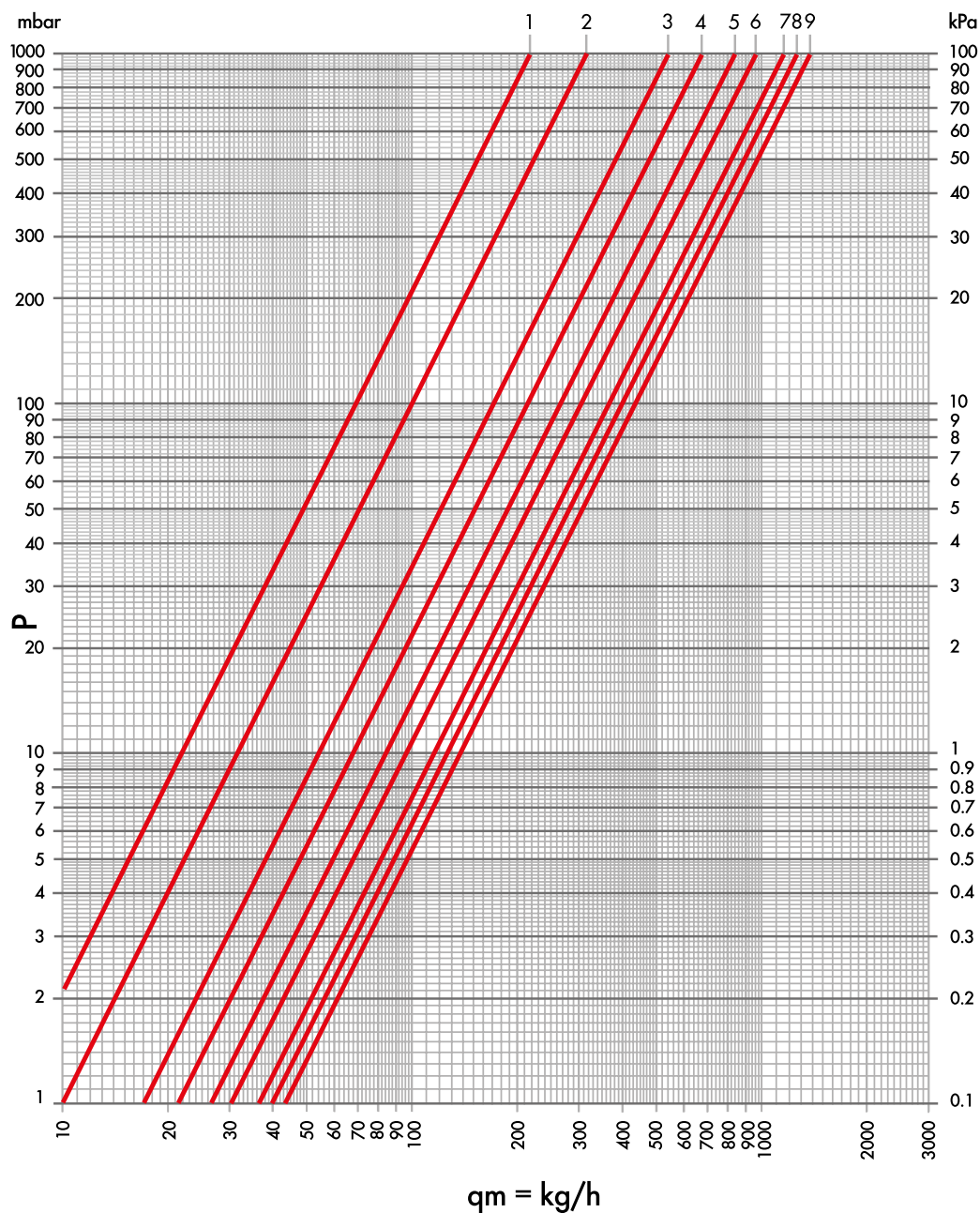

ARTICOLI	N. GIRI	Kvs	POS
DD 121 DD 125 DD 131 DD 138 DD 131/A DD 138/A	1	0.22	1
	1+1/2	0.32	2
	2	0.53	3
	2+1/2	0.68	4
	3	0.84	5
	3+1/2	0.97	6
	4	1.14	7
	4+1/2	1.25	8
	tutto aperto	1.34	9

DIAGRAMMI DI PORTATA DETENTORE

DETENTORE DIRITTO

DN 20 3/4

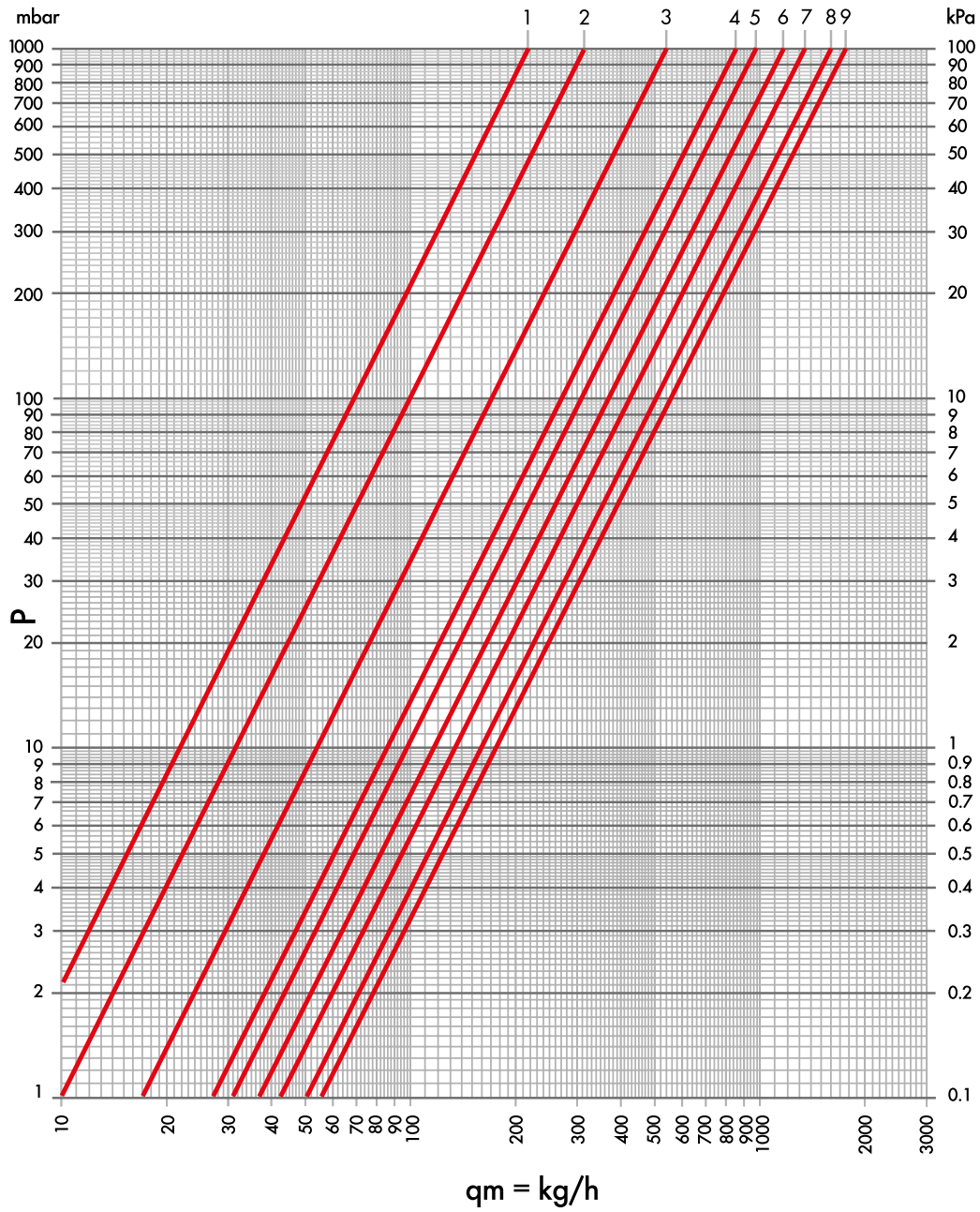

ARTICOLI	N. GIRI	Kvs	POS
DD 121 DD 125 DD 131 DD 138 DD 131/A DD 138/A	1	0.22	1
	1+1/2	0.32	2
	2	0.54	3
	2+1/2	0.85	4
	3	0.97	5
	3+1/2	1.19	6
	4	1.34	7
	4+1/2	1.60	8
	tutto aperto	1.75	9



VALVOLE RADIATORE

1.2 / THERMOTEKNA

THERMOTEKNA

CORPI VALVOLA TERMOSTATIZZABILI CON PREREGOLAZIONE

**REVERSE
FLOW**



* UNI EN 215
Approved

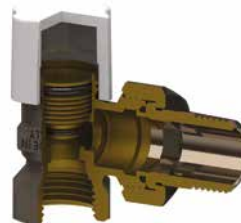
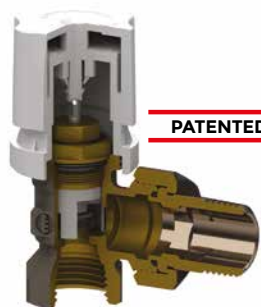

Le valvole ThermoTekna hanno un vitone che offre la possibilità di prerogolazione grazie ad un anello in acetilica sagomato. Il vitone termostatico permette la sostituzione di uno degli o-ring di tenuta sull'asta di comando senza che sia necessario svuotare l'impianto. Le valvole, dove segnalato, sono certificate UNI EN215. Le valvole sono prodotte con finitura nichelata. L'apertura delle valvole e detentori deve essere effettuata con pressione differenziale inferiore a un 1 bar.

I detentori Tekna hanno la tenuta assicurata da un o-ring sull'otturatore e se necessario da un ulteriore o-ring tra il corpo e il tappo. La tenuta in chiusura con l'otturatore è assicurata da un o-ring e da una tenuta conica metallica. I detentori sono prodotti con finitura nichelata. Tutti i detentori hanno la possibilità di regolare la portata limitando l'alzata dell'otturatore.

CARATTERISTICHE TECNICHE



DN

10
15
20



Max temperatura

120 °C



Max pressione

10 bar



Max pressione differenziale
(valvole termostatiche)

0,6 bar



Max pressione differenziale

1 bar



Materiale

CW617N
UNI EN
12165:2016



Manopola

ABS bianco
RAL 9016



Asta di comando

AISI 316



Collaudo

100%

ATTACCHI IMPIANTO



Tubo ferro

G 3/8
G 1/2
G 3/4



Tubo rame

W 24x19 - TR 91
G 3/4 EK - TR 91/A



Tubo plastica

W 24x19 - TP 95
G 3/4 EK - TP 98



Tubo multistrato

W 24x19 - TP 97
G 3/4 EK - TP 99

COLLEGAMENTO RADIATORE



**filetto
conico zigrinato**

G 3/8
G 1/2
G 3/4



**filetto
cilindrico con
tenuta morbida**

G 3/8
G 1/2
G 3/4

Tutte le valvole e i detentori vengono testati al 100% con prova di tenuta pneumatica a controllo elettronico.

Le caratteristiche del fluido dell'impianto devono essere conformi alla direttiva UNI 8065:2019.

REGOLAZIONE DELLA PORTATA E REVERSE FLOW

Per regolare la massima portata della valvola si deve agire nel seguente modo:

- allineare la tacca di riferimento presente sull'asta in acciaio inox con una delle posizioni stampate sul corpo della valvola.

Le valvole termostatiche Luxor hanno ottenuto la certificazione EN215 anche in condizione di flusso inverso.

Grazie a questa caratteristica possono essere installate sia sulla mandata sia sul ritorno del radiatore fino ad una pressione differenziale di 0,6 bar.

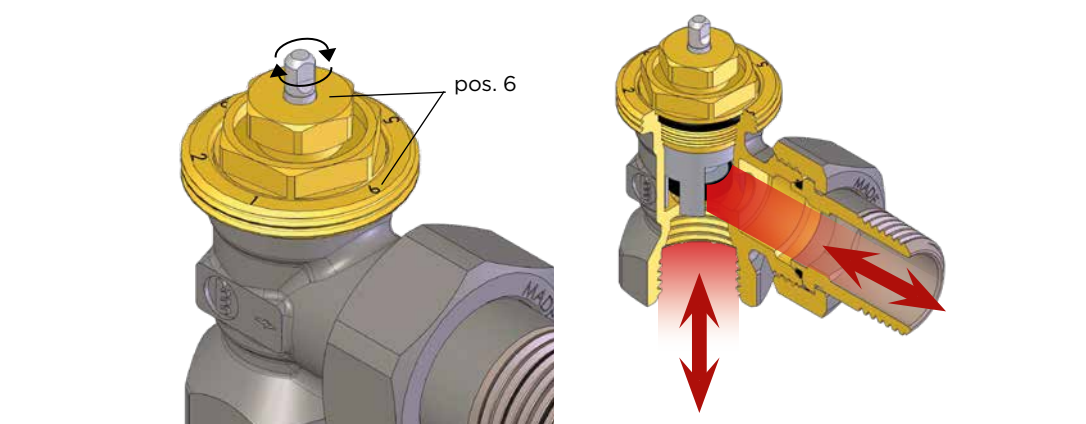
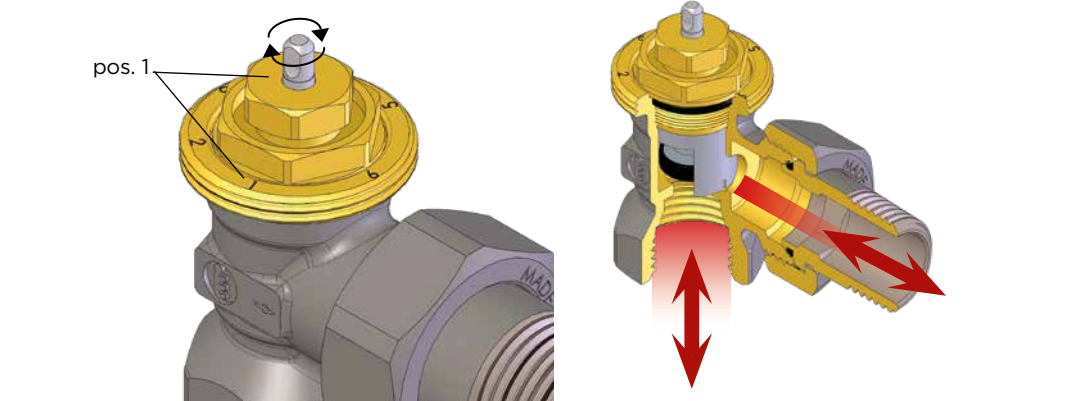

TENUTA SULLO STELO

Il sistema di tenuta può essere facilmente sostituito senza svuotare l'impianto:

- svitare la ghiera con testa esagonale con una chiave a stella da 13 mm;

- togliere l'o-ring "art. 582 - cod. 3424602", pulire l'asta in inox e inserire un nuovo o-ring "art. 582";
- montare la ghiera avvitando a fondo.

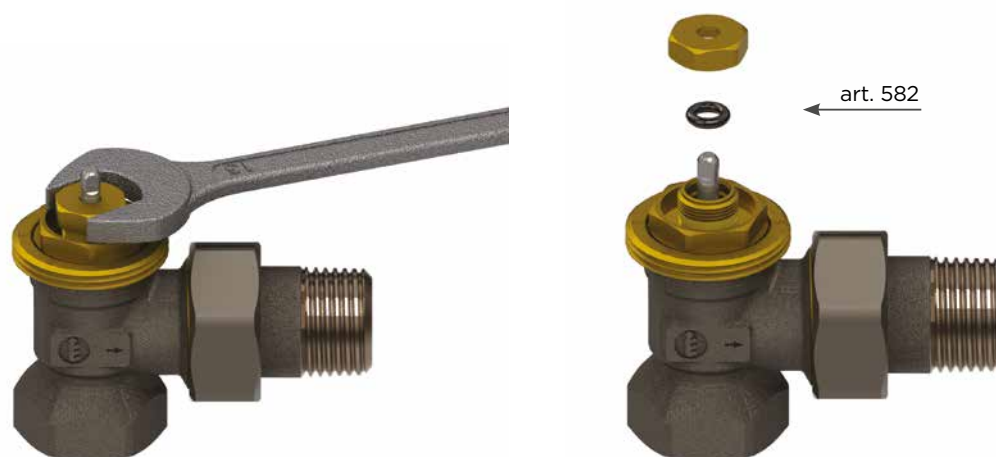

KIT TERMOSTATICI: ATTACCO TUBO FERRO



* UNI EN 215
Approved

KT 202

Kit termostatico completo per collegamento al radiatore. Composto da RS 202 + DS 22 + TT 3000. Attacco tubo ferro.

CODICE	MISURA						
12821700	DN 10 3/8	-	-	-	436	1	32
12822100*	DN 15 1/2	TR 92	-	TP 90	521	1	32
12822700	DN 20 3/4	-	-	-	671	1	32



KT 201

Kit termostatico completo per collegamento al radiatore. Composto da RD 201 + DD 21 + TT 3000. Attacco tubo ferro.

CODICE	MISURA						
12901700	DN 10 3/8	-	-	-	473	1	32
12902100	DN 15 1/2	TR 92	-	TP 90	514	1	32
12902700	DN 20 3/4	-	-	-	685	1	32



* UNI EN 215
Approved

KT 206

Kit termostatico completo per collegamento al radiatore. Composto da RS 206 + DS 26 + TT 3000. Attacco tubo ferro.

CODICE	MISURA						
12822117	DN 10 3/8	-	-	-	426	1	32
12822103*	DN 15 1/2	TR 92	-	TP 90	501	1	32
12822703	DN 20 3/4	-	-	-	636	1	32



KT 205

Kit termostatico completo per collegamento al radiatore. Composto da RD 205 + DD 25 + TT 3000. Attacco tubo ferro.

CODICE	MISURA						
12942117	DN 10 3/8	-	-	-	471	1	32
12942103	DN 15 1/2	TR 92	-	TP 90	536	1	32
12942703	DN 20 3/4	-	-	-	706	1	32

KIT TERMOSTATICI: ATTACCO TUBO RAME E TUBO PLASTICA W24x19



* UNI EN 215
Approved

KT 212

Kit termostatico completo per collegamento al radiatore. Composto da RS 212 + DS 32 + TT 3000. Attacco tubo rame e tubo plastica.

CODICE	MISURA						
12841700*	DN 10 3/8	TR 91	TP 95	TP 97	424	1	32
12842100*	DN 15 1/2	TR 91	TP 95	TP 97	477	1	32

**KT 211**

Kit termostatico completo per collegamento al radiatore. Composto da RD 211 + DD 31 + TT 3000. Attacco tubo rame e tubo plastica.

CODICE	MISURA						
12861700	DN 10 3/8	TR 91	TP 95	TP 97	445	1	32
12862100	DN 15 1/2	TR 91	TP 95	TP 97	492	1	32



* UNI EN 215
Approved

KT 209

Kit termostatico completo per collegamento al radiatore. Composto da RS 209 + DS 39 + TT 3000. Attacco tubo rame e tubo plastica.

CODICE	MISURA						
12842117*	DN 10 3/8	TR 91	TP 95	TP 97	441	1	32
12842103*	DN 15 1/2	TR 91	TP 95	TP 97	484	1	32

**KT 208**

Kit termostatico completo per collegamento al radiatore. Composto da RD 208 + DD 38 + TT 3000. Attacco tubo rame e tubo plastica.

CODICE	MISURA						
12962117	DN 10 3/8	TR 91	TP 95	TP 97	348	1	32
12962103	DN 15 1/2	TR 91	TP 95	TP 97	381	1	32



Raccordi per tubo rame



Raccordi per tubo plastica



Raccordi per tubo multistrato



Raccordi: capitolo 7



Accessori: capitolo 1.A

KIT TERMOSTATICI: ATTACCO TUBO RAME E TUBO PLASTICA G3/4 EUROCONO



* UNI EN 215
Approved

KT 212/A

Kit termostatico completo per collegamento al radiatore. Composto da RS 212/A + DS 32/A + TT 3000. Attacco tipo eurocono.

CODICE	MISURA						
12842718*	DN 10 3/8	TR 91/A	TP 98	TP 99	406	1	32
12842721*	DN 15 1/2	TR 91/A	TP 98	TP 99	483	1	32



KT 211/A

Kit termostatico completo per collegamento al radiatore. Composto da RD 211/A + DD 31/A + TT 3000. Attacco tipo eurocono.

CODICE	MISURA						
12862719	DN 10 3/8	TR 91/A	TP 98	TP 99	440	1	32
12862722	DN 15 1/2	TR 91/A	TP 98	TP 99	484	1	32



* UNI EN 215
Approved

KT 209/A

Kit termostatico completo per collegamento al radiatore. Composto da RS 209/A + DS 39/A + TT 3000. Attacco tipo eurocono.

CODICE	MISURA						
12842717*	DN 10 3/8	TR 91/A	TP 98	TP 99	447	1	32
12842703*	DN 15 1/2	TR 91/A	TP 98	TP 99	484	1	32



KT 208/A

Kit termostatico completo per collegamento al radiatore. Composto da RD 208/A + DD 38/A + TT 3000. Attacco tipo eurocono.

CODICE	MISURA						
12962717	DN 10 3/8	TR 91/A	TP 98	TP 99	340	1	32
12962703	DN 15 1/2	TR 91/A	TP 98	TP 99	380	1	32

ATTACCO TUBO FERRO

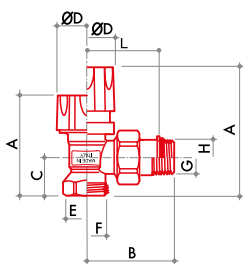
**RS 202**

Valvola radiatore a squadra termostattabile o elettrocomandabile con cappuccio di protezione. Attacco tubo ferro.



Raccordi



** Solo per le misure indicate

CODICE	MISURA	A	B	C	D	E	F	G	H	L			
12021700	DN 10 3/8	58	50	20	37	G 3/8	-	R 3/8	-	-	156	10	80
12022100*	DN 15 1/2**	60	53	23	37	G 1/2	-	R 1/2	-	-	198	10	80
12022700	DN 20 3/4	60	62	27	37	G 3/4	-	R 3/4	-	-	264	8	64

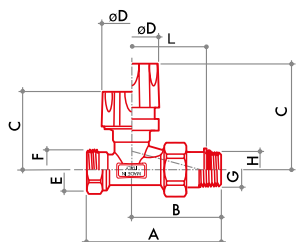
**RD 201**

Valvola radiatore diritta termostattabile o elettrocomandabile con cappuccio di protezione. Attacco tubo ferro.

Raccordi



** Solo per le misure indicate

CODICE	MISURA	A	B	C	D	E	F	G	H	L			
12221700	DN 10 3/8	76	51	46	37	G 3/8	-	R 3/8	-	-	177	10	80
12222100	DN 15 1/2**	83	55	46	37	G 1/2	-	R 1/2	-	-	216	10	80
12222700	DN 20 3/4	97	65	47	37	G 3/4	-	R 3/4	-	-	301	8	64

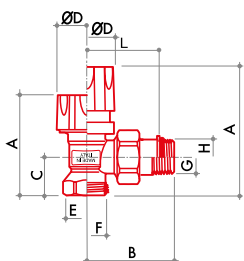
**RS 206**

Valvola radiatore a squadra termostattabile o elettrocomandabile con cappuccio di protezione. Attacco tubo ferro.



Raccordi



** Solo per le misure indicate

CODICE	MISURA	A	B	C	D	E	F	G	H	L			
12022117	DN 10 3/8	58	47	20	37	G 3/8	-	-	G 3/8	37	164	10	80
12022103*	DN 15 1/2**	61	49	23	37	G 1/2	-	-	G 1/2	39	202	10	80
12022703	DN 20 3/4	60	60	27	37	G 3/4	-	-	G 3/4	48	267	8	64

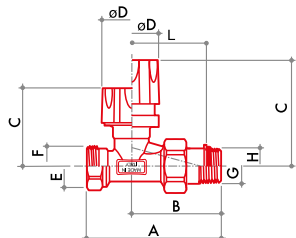
**RD 205**

Valvola radiatore diritta termostattabile o elettrocomandabile con cappuccio di protezione. Attacco tubo ferro.

Raccordi



** Solo per le misure indicate

CODICE	MISURA	A	B	C	D	E	F	G	H	L			
12222117	DN 10 3/8	73	48	46	37	G 3/8	-	-	G 3/8	38	185	10	80
12222103	DN 15 1/2**	78	51	46	37	G 1/2	-	-	G 1/2	40	220	10	80
12222703	DN 20 3/4	95	63	47	37	G 3/4	-	-	G 3/4	51	305	8	64



Raccordi per tubo rame



Raccordi per tubo plastica



Raccordi per tubo multistrato



Raccordi: capitolo 7



Accessori: capitolo 1.A

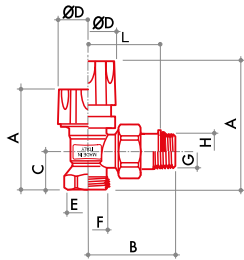

RS 2502

Valvola radiatore a squadra termostattizzabile o elettrocomandabile con volantino di comando manuale. Attacco tubo ferro.



Raccordi

**TR 92 - **TP 90
** Solo per le misure indicate

CODICE	MISURA	A	B	C	D	E	F	G	H	L			
12621700	DN 10 3/8	75	50	20	37	G 3/8	-	R 3/8	-	-	165	10	80
12622100*	DN 15 1/2**	78	53	23	37	G 1/2	-	R 1/2	-	-	201	10	80
12622700	DN 20 3/4	78	62	27	37	G 3/4	-	R 3/4	-	-	277	8	64

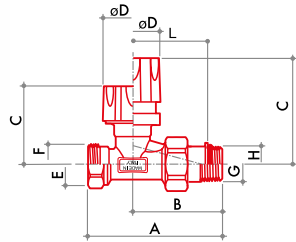

RD 2501

Valvola radiatore diritta termostattizzabile o elettrocomandabile con volantino di comando manuale. Attacco tubo ferro.

Raccordi

**TR 92 - **TP 90
** Solo per le misure indicate

CODICE	MISURA	A	B	C	D	E	F	G	H	L			
12421700	DN 10 3/8	76	51	64	37	G 3/8	-	R 3/8	-	-	184	10	80
12422100	DN 15 1/2**	83	55	64	37	G 1/2	-	R 1/2	-	-	220	10	80
12422700	DN 20 3/4	97	65	65	37	G 3/4	-	R 3/4	-	-	309	8	64

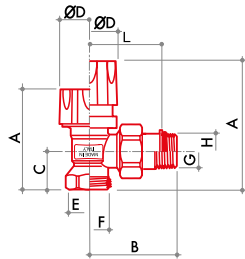

RS 2506

Valvola radiatore a squadra termostattizzabile o elettrocomandabile con volantino di comando manuale. Attacco tubo ferro.



Raccordi

**TR 92 - **TP 90
** Solo per le misure indicate

CODICE	MISURA	A	B	C	D	E	F	G	H	L			
12622117	DN 10 3/8	75	47	20	37	G 3/8	-	-	G 3/8	37	192	10	80
12622103*	DN 15 1/2**	78	49	23	37	G 1/2	-	-	G 1/2	39	224	10	80
12622703	DN 20 3/4	78	60	27	37	G 3/4	-	-	G 3/4	48	275	8	64

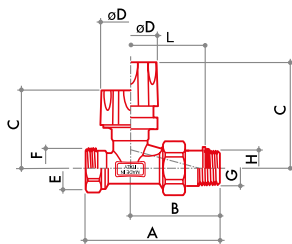

RD 2505

Valvola radiatore diritta termostattizzabile o elettrocomandabile con volantino di comando manuale. Attacco tubo ferro.

Raccordi

**TR 92 - **TP 90
** Solo per le misure indicate

CODICE	MISURA	A	B	C	D	E	F	G	H	L			
12422117	DN 10 3/8	73	48	64	37	G 3/8	-	-	G 3/8	38	173	10	80
12422103	DN 15 1/2**	78	51	64	37	G 1/2	-	-	G 1/2	40	205	10	80
12422703	DN 20 3/4	95	63	65	37	G 3/4	-	-	G 3/4	51	290	8	64

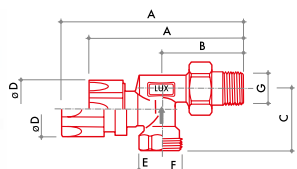

M 332

Valvola radiatore a corpo reverso termostattizzabile o elettrocomandabile con volantino di comando manuale. Attacchi tubo ferro.

Raccordi

**TR 92 - **TP 90
** Solo per le misure indicate

CODICE	MISURA	A	B	C	D	E	F	G	H	L			
13222100	DN 15 1/2	116	52	40	35	G 1/2	-	R 1/2	-	-	228	10	80

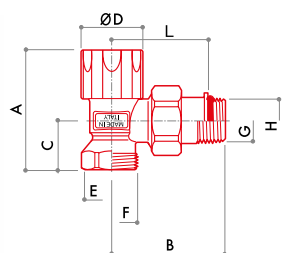
**DS 22**

Detentore di regolazione a squadra.
Attacco tubo ferro.

Raccordi



** Solo per le misure indicate

CODICE	MISURA	A	B	C	D	E	F	G	H	L			
10061700	DN 10 3/8	53	50	20	30	G 3/8	-	R 3/8	-	-	132	10	80
10062100	DN 15 1/2**	57	54	23	30	G 1/2	-	R 1/2	-	-	170	10	80
10062700	DN 20 3/4	57	62	27	30	G 3/4	-	R 3/4	-	-	244	8	64

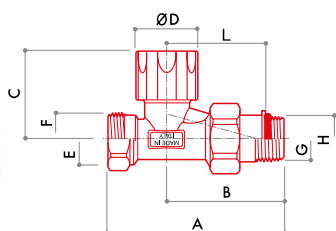
**DD 21**

Detentore di regolazione diritto.
Attacco tubo ferro.

Raccordi



** Solo per le misure indicate

CODICE	MISURA	A	B	C	D	E	F	G	H	L			
10261700	DN 10 3/8	76	51	41	30	G 3/8	-	R 3/8	-	-	153	10	80
10262100	DN 15 1/2**	83	55	42	30	G 1/2	-	R 1/2	-	-	187	10	80
10262700	DN 20 3/4	97	65	43	30	G 3/4	-	R 3/4	-	-	273	8	64

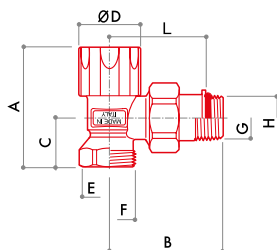
**DS 26**

Detentore di regolazione a squadra.
Attacco tubo ferro.

Raccordi



** Solo per le misure indicate

CODICE	MISURA	A	B	C	D	E	F	G	H	L			
10062117	DN 10 3/8	53	47	20	30	G 3/8	-	-	G 3/8	37	138	10	80
10062103	DN 15 1/2**	57	50	23	30	G 1/2	-	-	G 1/2	39	174	10	80
10062703	DN 20 3/4	57	57	27	30	G 3/4	-	-	G 3/4	45	247	8	64

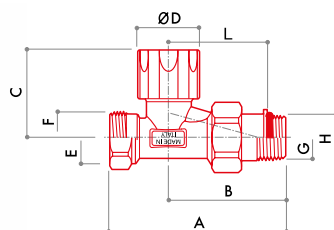
**DD 25**

Detentore di regolazione diritto.
Attacco tubo ferro.

Raccordi



** Solo per le misure indicate

CODICE	MISURA	A	B	C	D	E	F	G	H	L			
10262117	DN 10 3/8	73	48	41	30	G 3/8	-	-	G 3/8	38	159	10	80
10262103	DN 15 1/2**	78	51	42	30	G 1/2	-	-	G 1/2	40	191	10	80
10262703	DN 20 3/4	95	63	43	30	G 3/4	-	-	G 3/4	51	276	8	64



Raccordi per tubo rame



Raccordi per tubo plastica



Raccordi per tubo multistrato



Raccordi: capitolo 7



Accessori: capitolo 1.A

ATTACCO TUBO RAME E TUBO PLASTICA W24x19

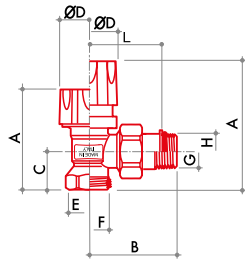

RS 212

Valvola radiatore a squadra termostattizzabile o elettrocomandabile con cappuccio di protezione. Attacco tubo rame e tubo plastica.



Raccordi



CODICE	MISURA	A	B	C	D	E	F	G	H	L			
12121700*	DN 10 3/8	57	52	19	37	-	W24x19	R 3/8	-	-	158	10	80
12122100*	DN 15 1/2	59	54	22	37	-	W24x19	R 1/2	-	-	182	10	80

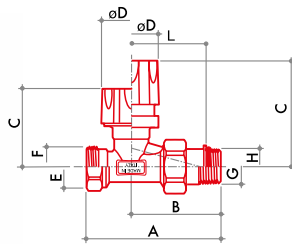

RD 211

Valvola radiatore diritta termostattizzabile o elettrocomandabile con cappuccio di protezione. Attacco tubo rame e tubo plastica.

Raccordi



CODICE	MISURA	A	B	C	D	E	F	G	H	L			
12321700	DN 10 3/8	76	51	46	37	-	W24x19	R 3/8	-	-	179	10	80
12322100	DN 15 1/2	81	55	46	37	-	W24x19	R 1/2	-	-	203	10	80

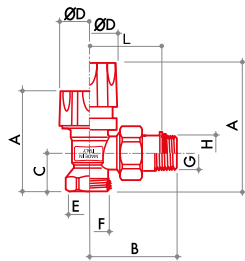

RS 209

Valvola radiatore a squadra termostattizzabile o elettrocomandabile con cappuccio di protezione. Attacco tubo rame e tubo plastica.



Raccordi



CODICE	MISURA	A	B	C	D	E	F	G	H	L			
12122117*	DN 10 3/8	57	47	19	37	-	W24x19	-	G 3/8	37	164	10	80
12122103*	DN 15 1/2	60	49	22	37	-	W24x19	-	G 1/2	39	185	10	80

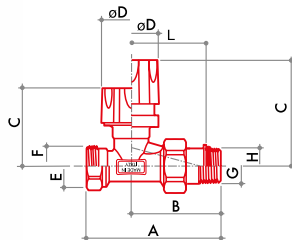

RD 208

Valvola radiatore diritta termostattizzabile o elettrocomandabile con cappuccio di protezione. Attacco tubo rame e tubo plastica.

Raccordi



CODICE	MISURA	A	B	C	D	E	F	G	H	L			
12322117	DN 10 3/8	73	48	46	37	-	W24x19	-	G 3/8	38	186	10	80
12322103	DN 15 1/2	78	51	46	37	-	W24x19	-	G 1/2	40	203	10	80

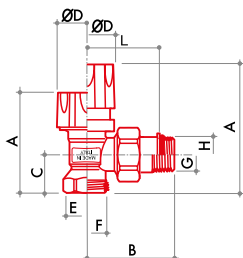

RS 2512

Valvola radiatore a squadra termostattizzabile o elettrocomandabile con volantino di comando manuale. Attacco tubo rame e tubo plastica.



Raccordi



CODICE	MISURA	A	B	C	D	E	F	G	H	L			
12721700*	DN 10 3/8	74	52	19	37	-	W24x19	R 3/8	-	-	166	10	80
12722100*	DN 15 1/2	77	54	22	37	-	W24x19	R 1/2	-	-	192	10	80

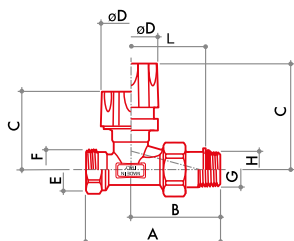

RD 2511

Valvola radiatore diritta termostattizzabile o elettrocomandabile con volantino di comando manuale. Attacco tubo rame e tubo plastica.

Raccordi



CODICE	MISURA	A	B	C	D	E	F	G	H	L			
12521700	DN 10 3/8	76	51	64	37	-	W24x19	R 3/8	-	-	185	10	80
12522100	DN 15 1/2	81	55	64	37	-	W24x19	R 1/2	-	-	207	10	80

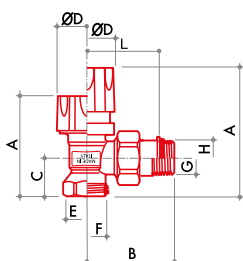

RS 2509

Valvola radiatore a squadra termostattizzabile o elettrocomandabile con volantino di comando manuale. Attacco tubo rame e tubo plastica.



Raccordi



CODICE	MISURA	A	B	C	D	E	F	G	H	L			
12722117*	DN 10 3/8	74	47	19	37	-	W24x19	-	G 3/8	37	172	10	80
12722103*	DN 15 1/2	77	49	22	37	-	W24x19	-	G 1/2	39	193	10	80

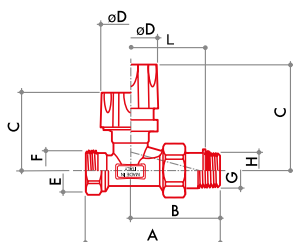

RD 2508

Valvola radiatore diritta termostattizzabile o elettrocomandabile con volantino di comando manuale. Attacco tubo rame e tubo plastica.

Raccordi



CODICE	MISURA	A	B	C	D	E	F	G	H	L			
12522117	DN 10 3/8	73	48	64	37	-	W24x19	-	G 3/8	38	194	10	80
12522103	DN 15 1/2	77	51	64	37	-	W24x19	-	G 1/2	40	211	10	80

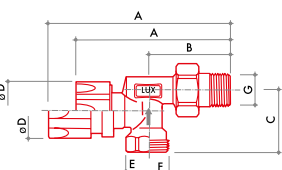

M 330

Valvola radiatore a corpo reverso termostattizzabile o elettrocomandabile con volantino di comando manuale. Attacco tubo rame e tubo plastica.

Raccordi



CODICE	MISURA	A	B	C	D	E	F	G	H	L			
13122100	DN 15 1/2	116	52	39	35	-	W24x19	R 1/2	-	-	215	10	80



Raccordi per tubo rame



Raccordi per tubo plastica



Raccordi per tubo multistrato



Raccordi: capitolo 7



Accessori: capitolo 1.A

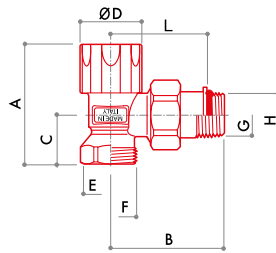

DS 32

Detentore di regolazione a squadra.
Attacco tubo rame e tubo plastica.

Raccordi



CODICE	MISURA	A	B	C	D	E	F	G	H	L	Ⓔ	Ⓜ	Ⓝ
10161700	DN 10 3/8	52	50	19	30	-	W24x19	R 3/8	-	-	130	10	80
10162100	DN 15 1/2	56	54	22	30	-	W24x19	R 1/2	-	-	159	10	80

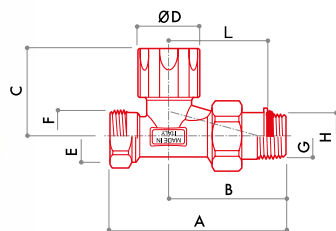

DD 31

Detentore di regolazione diretto.
Attacco tubo rame e tubo plastica.

Raccordi



CODICE	MISURA	A	B	C	D	E	F	G	H	L	Ⓔ	Ⓜ	Ⓝ
10361700	DN 10 3/8	76	51	41	30	-	W24x19	R 3/8	-	-	155	10	80
10362100	DN 15 1/2	82	55	42	30	-	W24x19	R 1/2	-	-	178	10	80

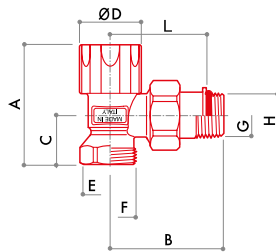

DS 39

Detentore di regolazione a squadra.
Attacco tubo rame e tubo plastica.

Raccordi



CODICE	MISURA	A	B	C	D	E	F	G	H	L	Ⓔ	Ⓜ	Ⓝ
10162117	DN 10 3/8	52	47	19	30	-	W24x19	-	G 3/8	37	141	10	80
10162103	DN 15 1/2	56	49	22	30	-	W24x19	-	G 1/2	39	163	10	80

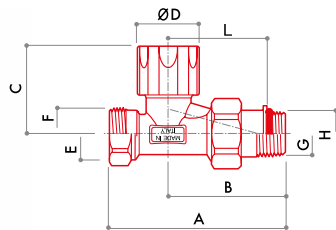

DD 38

Detentore di regolazione diretto.
Attacco tubo rame e tubo plastica.

Raccordi



CODICE	MISURA	A	B	C	D	E	F	G	H	L	Ⓔ	Ⓜ	Ⓝ
10362117	DN 10 3/8	73	48	41	30	-	W24x19	-	G 3/8	38	162	10	80
10362103	DN 15 1/2	77	51	42	30	-	W24x19	-	G 1/2	40	178	10	80

ATTACCO TUBO RAME E TUBO PLASTICA G3/4 EUROCONO

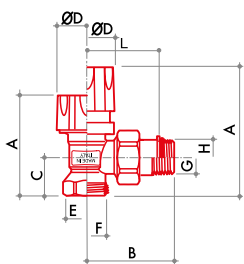
**RS 212/A**

Valvola radiatore a squadra termostattabile o elettrocomandabile con cappuccio di protezione. Attacco tipo eurocono.



Raccordi

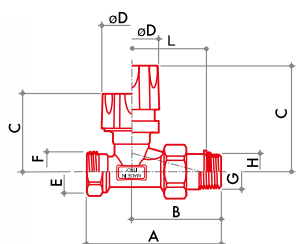

CODICE	MISURA	A	B	C	D	E	F	G	H	L			
12122718*	DN 10 3/8	56	50	19	37	-	G 3/4 EK	R 3/8	-	-	157	10	80
12122721*	DN 15 1/2	59	54	22	37	-	G 3/4 EK	R 1/2	-	-	181	10	80

**RD 211/A**

Valvola radiatore diritta termostattabile o elettrocomandabile con cappuccio di protezione. Attacco tipo eurocono.

Raccordi

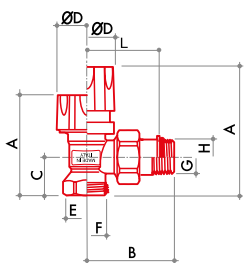

CODICE	MISURA	A	B	C	D	E	F	G	H	L			
12322719	DN 10 3/8	77	52	46	37	-	G 3/4 EK	R 3/8	-	-	170	10	80
12322722	DN 15 1/2	81	55	46	37	-	G 3/4 EK	R 1/2	-	-	199	10	80

**RS 209/A**

Valvola radiatore a squadra termostattabile o elettrocomandabile con cappuccio di protezione. Attacco tipo eurocono.



Raccordi

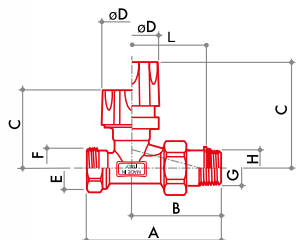

CODICE	MISURA	A	B	C	D	E	F	G	H	L			
12122717*	DN 10 3/8	57	47	19	37	-	G 3/4 EK	-	G 3/8	37	163	10	80
12122703*	DN 15 1/2	60	49	22	37	-	G 3/4 EK	-	G 1/2	39	184	10	80

**RD 208/A**

Valvola radiatore diritta termostattabile o elettrocomandabile con cappuccio di protezione. Attacco tipo eurocono.

Raccordi



CODICE	MISURA	A	B	C	D	E	F	G	H	L			
12322717	DN 10 3/8	73	48	46	37	-	G 3/4EK	-	G 3/8	38	182	10	80
12322703	DN 15 1/2	77	51	46	37	-	G 3/4EK	-	G 1/2	40	199	10	80



Raccordi per tubo rame



Raccordi per tubo plastica



Raccordi per tubo multistrato



Raccordi: capitolo 7



Accessori: capitolo 1.A

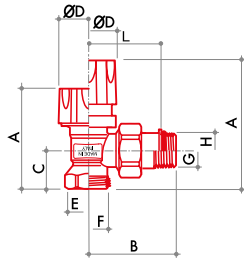

RS 2512/A

Valvola radiatore a squadra termostattizzabile o elettrocomandabile con volantino di comando manuale. Attacco tipo eurocono.



Raccordi



CODICE	MISURA	A	B	C	D	E	F	G	H	L			
12722718*	DN 10 3/8	74	50	19	37	-	G 3/4 EK	R 3/8	-	-	163	10	80
12722721*	DN 15 1/2	77	54	22	37	-	G 3/4 EK	R 1/2	-	-	189	10	80

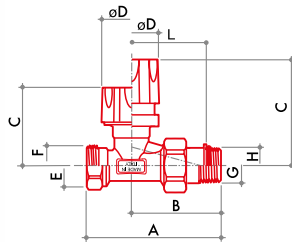

RD 2511/A

Valvola radiatore diretta termostattizzabile o elettrocomandabile con volantino di comando manuale. Attacco tipo eurocono.

Raccordi



CODICE	MISURA	A	B	C	D	E	F	G	H	L			
12522719	DN 10 3/8	77	52	64	37	-	G 3/4 EK	R 3/8	-	-	196	10	80
12522722	DN 15 1/2	81	55	64	37	-	G 3/4 EK	R 1/2	-	-	207	10	80

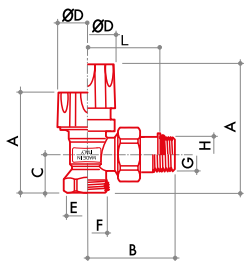

RS 2509/A

Valvola radiatore a squadra termostattizzabile o elettrocomandabile con volantino di comando manuale. Attacco tipo eurocono.



Raccordi

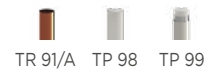

CODICE	MISURA	A	B	C	D	E	F	G	H	L			
12722717*	DN 10 3/8	74	47	19	37	-	G 3/4EK	-	G 3/8	37	171	10	80
12722703*	DN 15 1/2	77	49	22	37	-	G 3/4EK	-	G 1/2	39	192	10	80

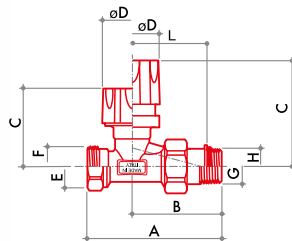

RD 2508/A

Valvola radiatore diretta termostattizzabile o elettrocomandabile con volantino di comando manuale. Attacco tipo eurocono.

Raccordi



CODICE	MISURA	A	B	C	D	E	F	G	H	L			
12522717	DN 10 3/8	73	48	64	37	-	G 3/4EK	-	G 3/8	38	190	10	80
12522703	DN 15 1/2	77	51	64	37	-	G 3/4EK	-	G 1/2	40	207	10	80

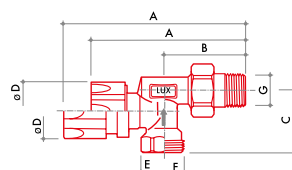

M 330/A

Valvola radiatore a corpo reverso termostattizzabile o elettrocomandabile con volantino di comando manuale. Attacchi tipo eurocono.

Raccordi

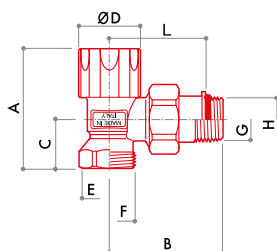

CODICE	MISURA	A	B	C	D	E	F	G	H	L			
13122721	DN 15 1/2	116	52	39	35	-	G 3/4 EK	R 1/2	-	-	217	10	80

**DS 32/A**

Detentore di regolazione a squadra.
Attacco tipo eurocono.

Raccordi

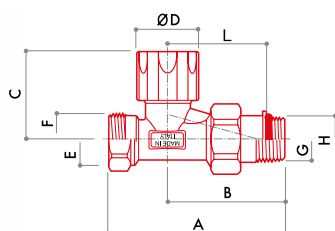

CODICE	MISURA	A	B	C	D	E	F	G	H	L			
10162718	DN 10 3/8	52	50	19	30	-	G 3/4 EK	R 3/8	-	-	139	10	80
10162721	DN 15 1/2	56	54	22	30	-	G 3/4 EK	R 1/2	-	-	162	10	80

**DD 31/A**

Detentore di regolazione dritto.
Attacco tipo eurocono.

Raccordi

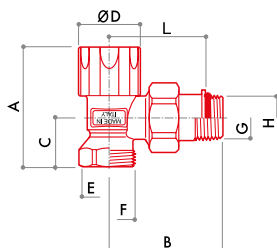

CODICE	MISURA	A	B	C	D	E	F	G	H	L			
10362719	DN 10 3/8	76	51	41	30	-	G 3/4 EK	R 3/8	-	-	164	10	80
10362722	DN 15 1/2	82	55	42	30	-	G 3/4 EK	R 1/2	-	-	174	10	80

**DS 39/A**

Detentore di regolazione a squadra.
Attacco tipo eurocono.

Raccordi

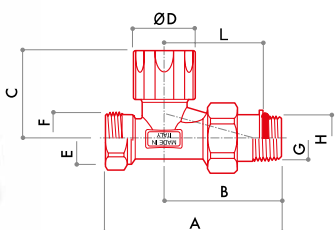

CODICE	MISURA	A	B	C	D	E	F	G	H	L			
10162717	DN 10 3/8	52	47	19	30	-	G 3/4 EK	-	G 3/8	37	144	10	80
10162703	DN 15 1/2	56	49	22	30	-	G 3/4 EK	-	G 1/2	39	166	10	80

**DD 38/A**

Detentore di regolazione dritto.
Attacco tipo eurocono.

Raccordi



CODICE	MISURA	A	B	C	D	E	F	G	H	L			
10362717	DN 10 3/8	73	48	41	30	-	G 3/4 EK	-	G 3/8	38	165	10	80
10362703	DN 15 1/2	77	51	42	30	-	G 3/4 EK	-	G 1/2	40	178	10	80



Raccordi per tubo rame



Raccordi per tubo plastica



Raccordi per tubo multistrato



Raccordi: capitolo 7



Accessori: capitolo 1.A

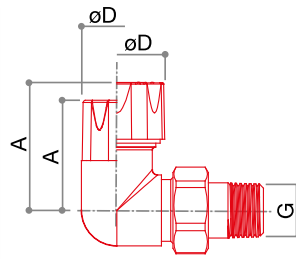

MD 321/A

Valvola radiatore coassiale destra termostattizzabile o elettrocomandabile con cappuccio di protezione. Attacco tipo eurocono.

Raccordi



CODICE	MISURA	A	B	C	D	E	F	G	H	L			
13272722	DN 15 1/2	49	56	27	37	-	G 3/4 EK	R 1/2	-	-	287	10	80

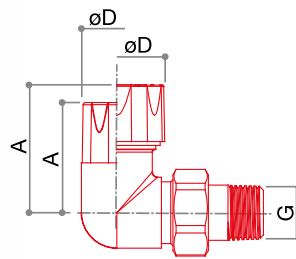

MS 331/A

Detentore di regolazione coassiale sinistro. Attacchi tipo eurocono.

Raccordi



CODICE	MISURA	A	B	C	D	E	F	G	H	L			
13252722	DN 15 1/2	42	56	27	30	-	G 3/4 EK	R 1/2	-	-	258	10	80

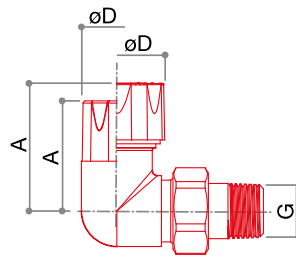

MS 321/A

Valvola radiatore coassiale sinistra termostattizzabile o elettrocomandabile con cappuccio di protezione. Attacco tipo eurocono.

Raccordi



CODICE	MISURA	A	B	C	D	E	F	G	H	L			
13292722	DN 15 1/2	49	56	27	37	-	G 3/4 EK	R 1/2	-	-	287	10	80

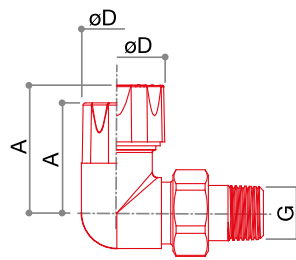

MD 331/A

Detentore di regolazione coassiale destro. Attacco tipo eurocono.

Raccordi



CODICE	MISURA	A	B	C	D	E	F	G	H	L			
13232722	DN 15 1/2	42	56	27	30	-	G 3/4 EK	R 1/2	-	-	258	10	80

TT 3000

TESTA TERMOSTATICA



* UNI EN 215
Approved

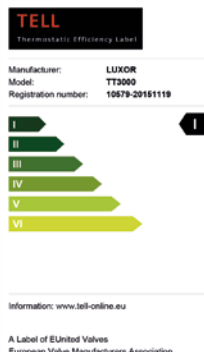

CARATTERISTICHE TECNICHE



Max temperatura
120 °C



Max pressione
10 bar



Max pressione
differenziale
0,6 bar

Temperatura min. di regolazione (pos. antigelo)

Ts min 6 °C

Temperatura max di regolazione (pos. max)

Ts max 30 °C (5)

Condizioni di risparmio

20 °C

Campo di inalterabilità dell'elemento termostatico

-15 °C ÷ 60 °C

Temperatura di stoccaggio

-20 °C ÷ + 50 °C

Isteresi

C 0,4 k

Influenza della pressione

D 0,5 k

Influenza della temperatura dell'acqua

W 0,25 k

Tempo di risposta

Z 22 min.

Control Accuracy

CA 0,2 K.

ATTACCO VALVOLA



M 30 x 1,5

Disponibile anche
con finitura cromata
(capitolo Serie 50th)



CHROME



WHITE-CHROME

CARATTERISTICHE COSTRUTTIVE

Le teste termostatiche sono costituite da un sensore riempito con un elemento ad alta espansibilità.

L'elemento, che si trova all'interno della manopola di regolazione o nel sensore a distanza, è in grado di dilatarsi o ridursi proporzionalmente all'aumento o alla diminuzione di temperatura ambiente, registrando anche minime variazioni.

Quando la temperatura circostante aumenta, l'elemento si espande e, attraverso il movimento assiale di spinta, influenza la posizione dell'otturatore, controllando così l'azione della valvola.

Con la chiusura e l'apertura della valvola è possibile regolare il flusso del fluido termovettore.

CARATTERISTICHE TECNICHE IN ABBINAMENTO CON LA TESTA TT 3000

POS	ARTICOLI	Kv Δt 1 °C	Kv ΔT 1 °C	qmN (Kg/h)	qm max (Kg/h)	a
1	RS 202 DN 15 - RS 206 DN 15	0.07	0.07	23±65%	32	0.42
2	RS212 DN10 - RS212 DN15 RS209 DN10 - RS209 DN15	0.20	0.25	80±40%	100	0.36
3	RS212/A DN15 - RS209/A DN15	0.24	0.36	113±30%	155	0.46
4	RS2502 DN15 - RS2506 DN15 RS2512 DN10 - RS2512 DN15	0.24	0.37	116±20%	180	0.57
5	RS2509 DN10 - RS2509 DN15	0.24	0.40	128±20%	250	0.74
6	RS2512/A DN15 - RS2509/A DN15	0.32	0.52	165±10%	440	0.84

CAMPO DI REGOLAZIONE

Con l'impiego delle valvole termostatiche si ha la possibilità di rendere ogni locale autonomo con una specifica temperatura impostata aumentando così il comfort ambientale oltre ad un effettivo risparmio energetico come richiesto dalle normative nazionali ed internazionali.

Le teste termostatiche hanno la possibilità di mantenere una temperatura di antigelo nella posizione "❄", questo è molto utile quando non si utilizzano locali e si vuole comunque evitare il problema di danni causati dal gelo. Durante il periodo estivo, invece, è consigliabile posizionare le teste sulla massima apertura "5".

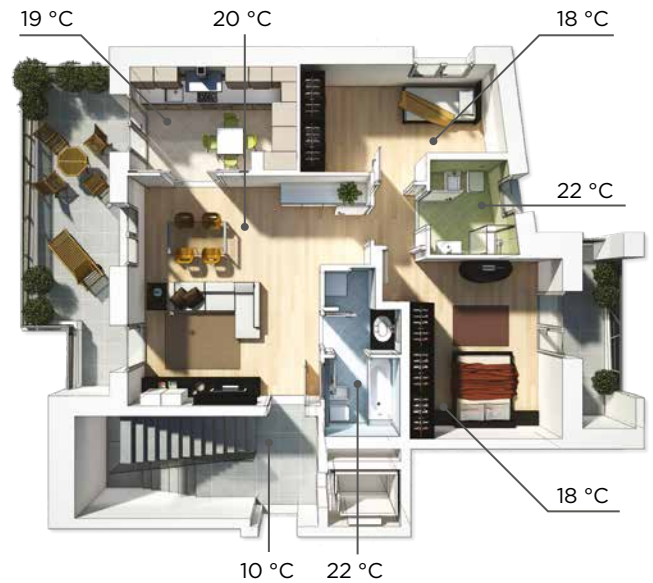
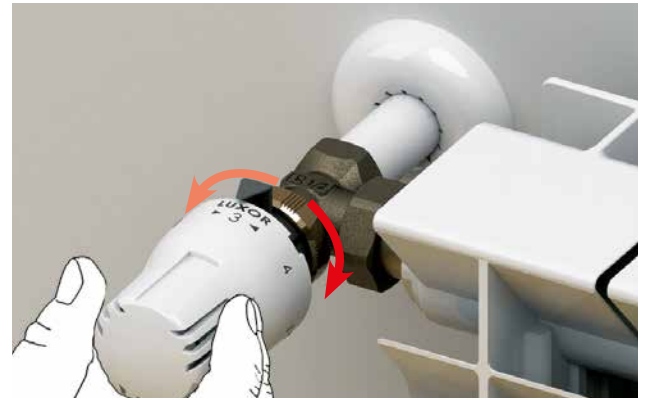
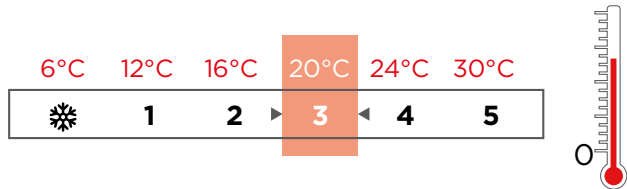

ISTRUZIONI DI UTILIZZO

Prima di procedere all'installazione della testa termostatica, portare il selettore in posizione "5", in modo da facilitare le successive operazioni di installazione.

Successivamente svitare il cappuccio di protezione in ABS bianco RAL 9016 montato sulle valvole termostattabili serie ThermoTekna. Avvitare sullo stesso filetto del corpo la ghiera in ottone della testa termostatica. Quindi posizionare il selettore alla temperatura desiderata.



LIMITAZIONI E BLOCCO DELLA TEMPERATURA



Utilizzando il perno a forcella apposito si può limitare o bloccare la temperatura della testa.

Se si vuole bloccare la regolazione al valore "3" si deve, per prima cosa, ruotare la testa fino al raggiungimento della posizione desiderata. Nella parte inferiore, diametralmente opposto all'indice, è presente una linguetta.

Inserendo il perno a cavallo di questa linguetta si avrà il blocco della temperatura (fig. 1).

Inserendo il perno a sinistra della linguetta si avrà una limitazione che andrà dal valore "3" al valore "5" (fig. 2) mentre inserendolo a destra avremo una limitazione dal valore "3" al valore "❄" (fig. 3).

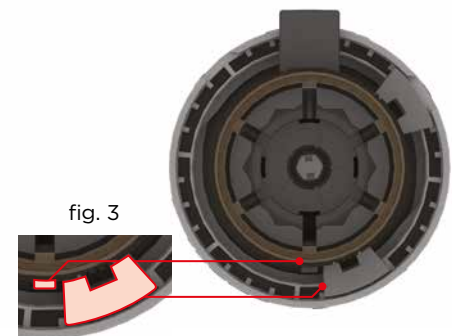
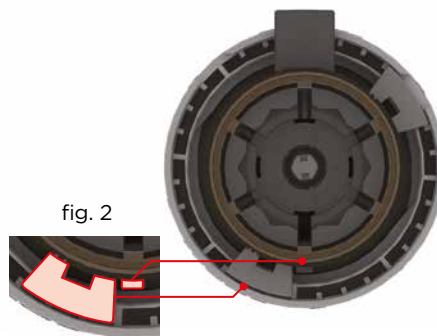
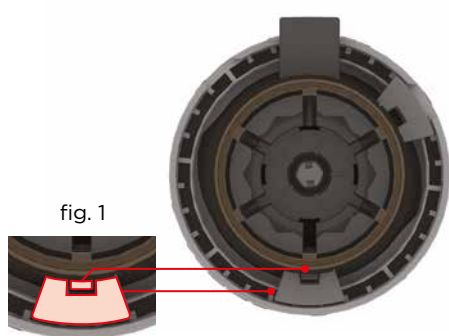

AVVERTENZE PER L'INSTALLAZIONE



Le teste termostatiche **TT 3000** possono essere applicate a tutti i corpi scaldanti liberi di trasmettere il calore nell'ambiente. Nel caso ci siano barriere, come mensole, tendaggi o mobili, che possono immagazzinare calore e quindi falsare la rilevazione della temperatura ambiente da parte delle teste termostatiche, devono essere utilizzate teste termostatiche con sensore a distanza **TT 3002**.

In un impianto dove tutti i corpi scaldanti sono comandati da teste termostatiche, è opportuno inserire una valvola di bypass. Questa ha il compito di evitare la formazione di possibili rumori dovuti alla differenza di pressione troppo elevata che si può verificare all'interno delle valvole termostatiche.

Le teste termostatiche devono essere installate fuori dai flussi di calore che circondano gli elementi riscaldanti (fig. 1) e al riparo da raggi solari (fig. 2).

Evitare quindi di installare la testa termostatica sotto i ripiani (fig. 3) o in nicchia (fig. 4), all'interno del flusso dell'aria calda (fig. 5) o dietro tende (fig. 6).

Queste installazioni non sono corrette in quanto la testa termostatica valuterrebbe una temperatura diversa da quella presente nella stanza.



Se l'installazione fosse posizionata come in fig. 7 si potrebbe verificare una serie di problematiche. La porta, ovviamente, non si potrebbe aprire completamente e, se non prevista di fermo, potrebbe andare ad impattare con la testa provocandone la rottura e causando danni alla porta stessa.

In questo caso si consiglia di utilizzare una valvola termostattabile a corpo reverso come mostrato in fig. 8.

TESTE TERMOSTATICHE

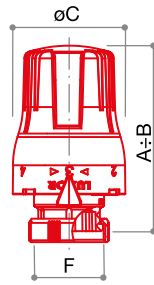

TT 3000

Testa termostatica con comando e sensore incorporato.



CODICE	MISURA	A	B	C	D	E	F	G	H	L			
69100000	M30x1,5	75	80	46,5	-	-	M30x1,5	-	-	-	110	1	100

CODICE	MISURA	A	B	C	D	E	F	G	H	L			
69100000BRA*	M30x1,5	75	80	46,5	-	-	M30x1,5	-	-	-	110	1	100

*Con numerazione Braille

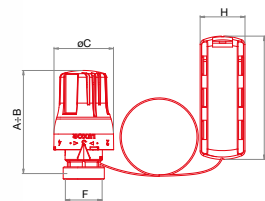

TT 3002

Testa termostatica con comando incorporato e sensore a distanza. Lunghezza standard del capillare trasmettitore 2 m.

CODICE	MISURA	A	B	C	D	E	F	G	H	L			
69100020	M30x1,5	75	80	46,5	-	-	M30x1,5	-	35	96	156	1	32



BT 242

Fascetta antimanomissione e antifurto blocca ghiera per testa TT 3000 e TT 3002.

CODICE	MISURA			
69010402	-	14	5	160

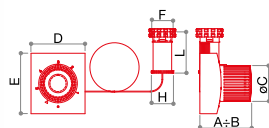

TT 2302

Testa termostatica sottotraccia con comando e sensore a distanza. Lunghezza standard del capillare trasmettitore 2m.

CODICE	MISURA	A	B	C	D	E	F	G	H	L			
69011005	M30x1,5	63	68	45	67	75	M30x1,5	-	28	51	220	1	30



La certificazione delle valvole, secondo la norma UNI EN 215, è intesa come la combinazione valvola e testa termostatica TT 3000 LUXOR. **Tutte le informazioni tecniche sono disponibili su: www.luxor.it**

DIAGRAMMA DI PORTATA VALVOLE

VALVOLE SQUADRA

DN 10 - DN 15

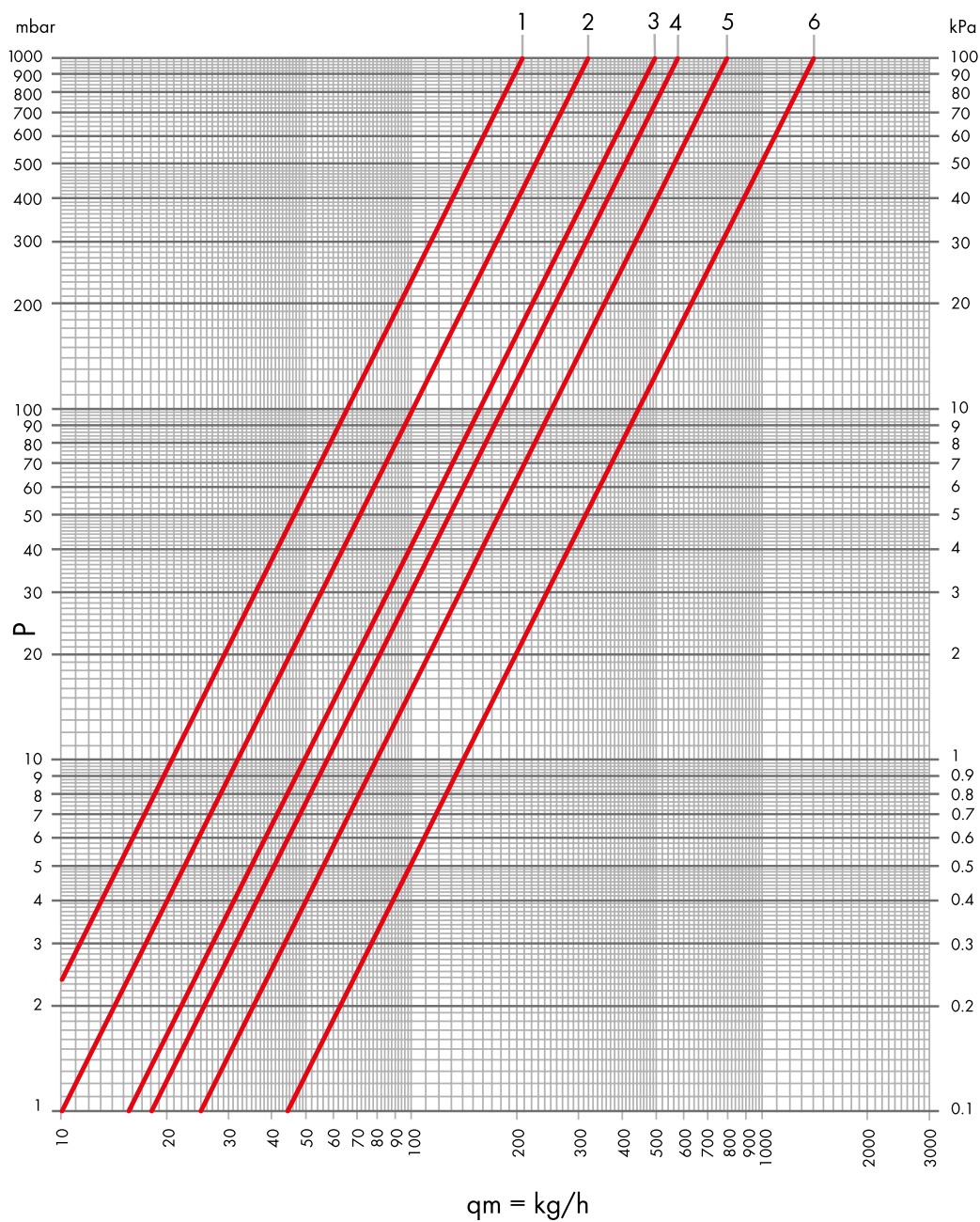

ARTICOLI	Kv	Kv Δt 1 °C	Kv Δt 2 °C	POS
Squadra DN 10 - DN 15	0.10	0.07	0.07	1
	0.32	0.20	0.25	2
	0.49	0.24	0.36	3
	0.57	0.24	0.37	4
	0.79	0.24	0.40	5
	1.39	0.32	0.55	6

DIAGRAMMA DI PORTATA VALVOLE

VALVOLE SQUADRA

DN 20

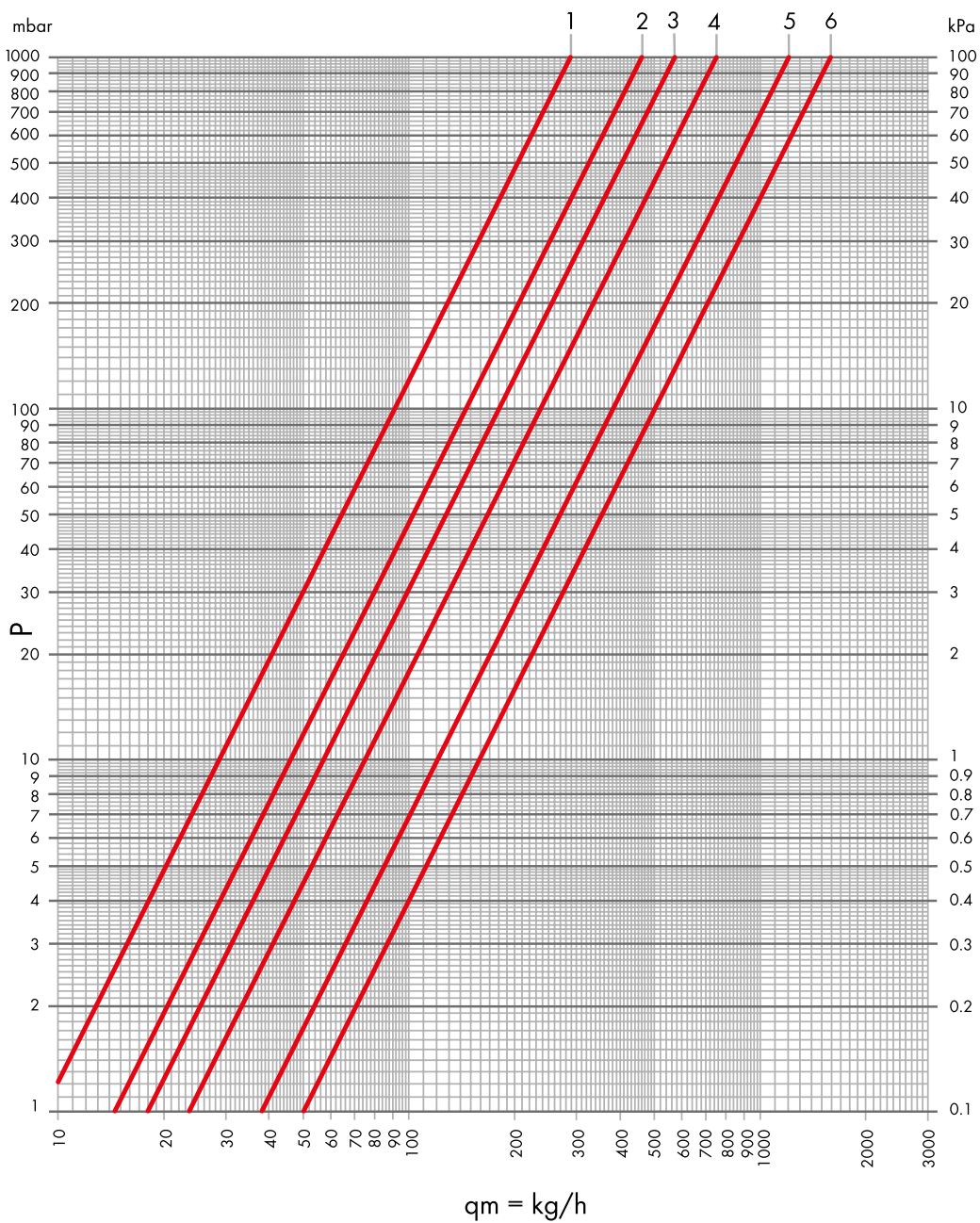

ARTICOLI	Kv	Kv Δt 1 °C	Kv Δt 2 °C	POS
Squadra DN 20	0.29	0.15	0.19	1
	0.49	0.20	0.25	2
	0.57	0.24	0.36	3
	0.75	0.26	0.41	4
	1.20	0.31	0.55	5
	1.58	0.32	0.56	6

DIAGRAMMA DI PORTATA VALVOLE

VALVOLE DIRITTE

DN 10 - DN 15

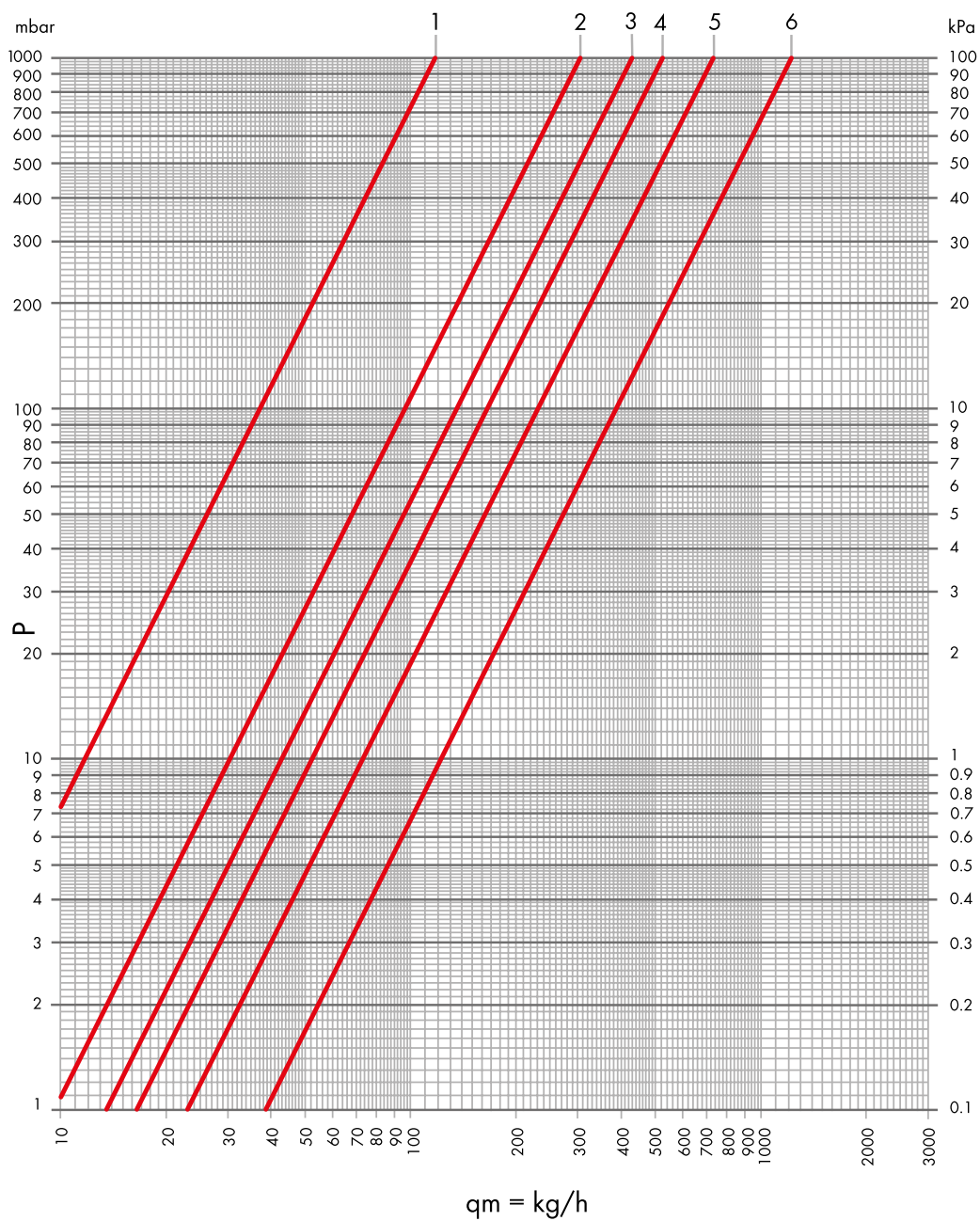

ARTICOLI	Kv	Kv Δt 1 °C	Kv Δt 2 °C	POS
Diritta DN 10 - DN 15	0.12	0.10	0.11	1
	0.30	0.20	0.25	2
	0.43	0.24	0.36	3
	0.52	0.24	0.37	4
	0.72	0.24	0.40	5
	1.21	0.29	0.49	6

DIAGRAMMA DI PORTATA VALVOLE

VALVOLE DIRITTE
DN 20

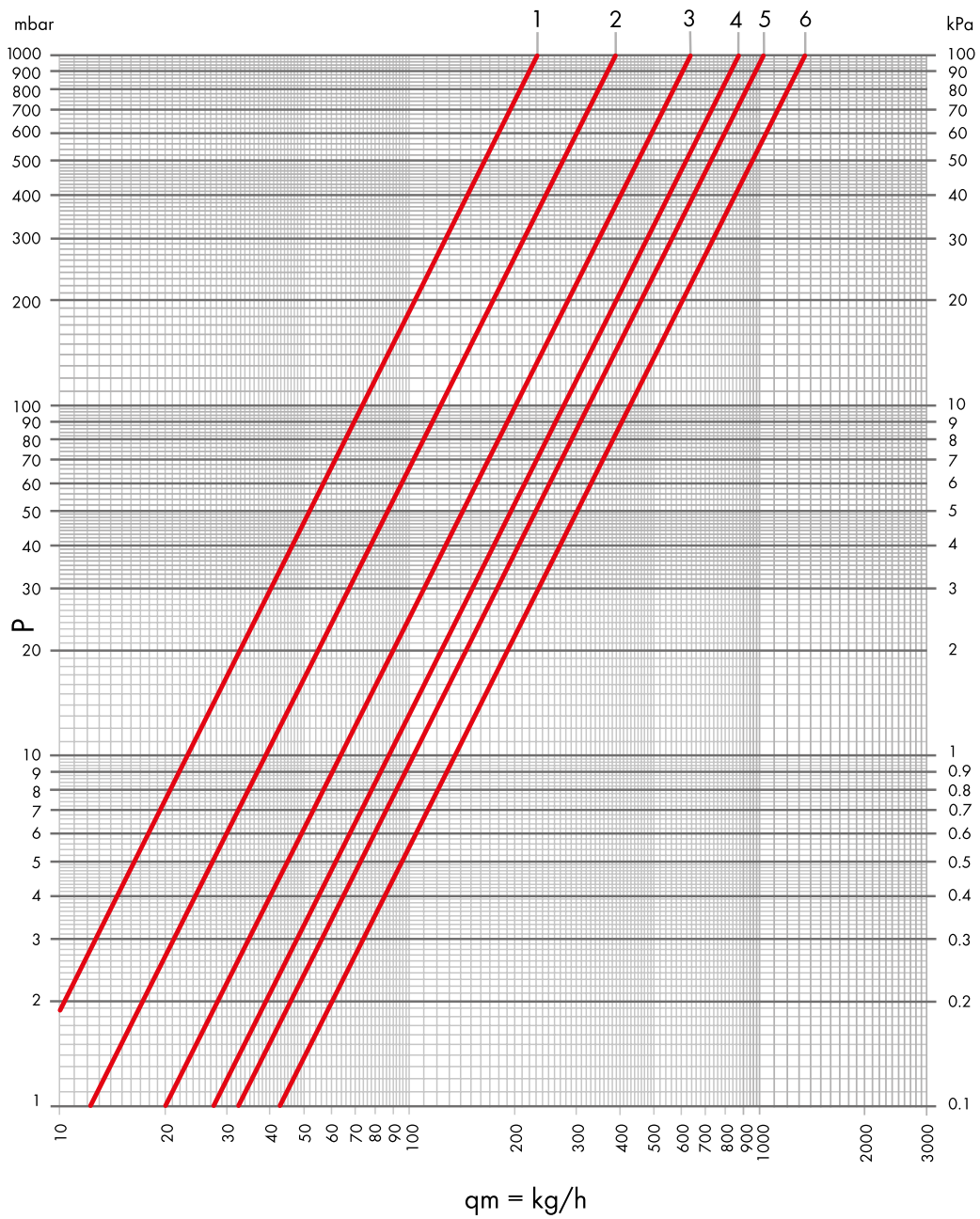

ARTICOLI	Kv	Kv Δt 1 °C	Kv Δt 2 °C	POS
Diritta DN 20	0.23	0.16	0.19	1
	0.39	0.22	0.25	2
	0.63	0.25	0.36	3
	0.87	0.29	0.41	4
	1.02	0.30	0.50	5
	1.34	0.31	0.52	6

DIAGRAMMA DI PORTATA DETENTORE

DETENTORE A SQUADRA

DN 10 3/8

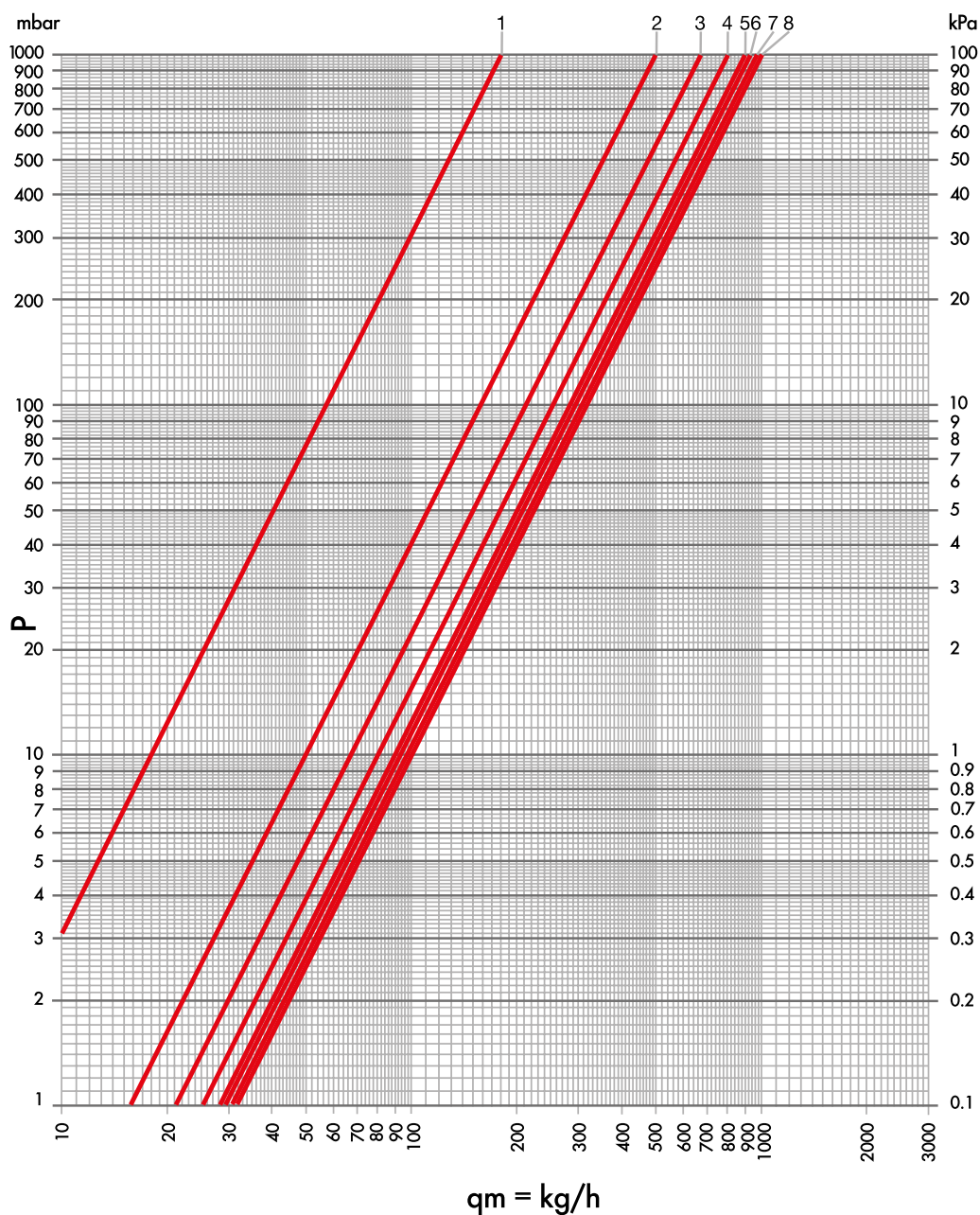

ARTICOLI	N. GIRI	Kvs	POS
	1	0.18	1
	1+1/2	0.50	2
	2	0.67	3
DS 22 DS 26 DS 32	2+1/2	0.80	4
DS 39 DS 32/A DS 39/A	3	0.90	5
	3+1/2	0.93	6
	4	0.97	7
	tutto aperto	1.00	8

DIAGRAMMA DI PORTATA DETENTORE

DETENTORE A SQUADRA

DN 15 1/2

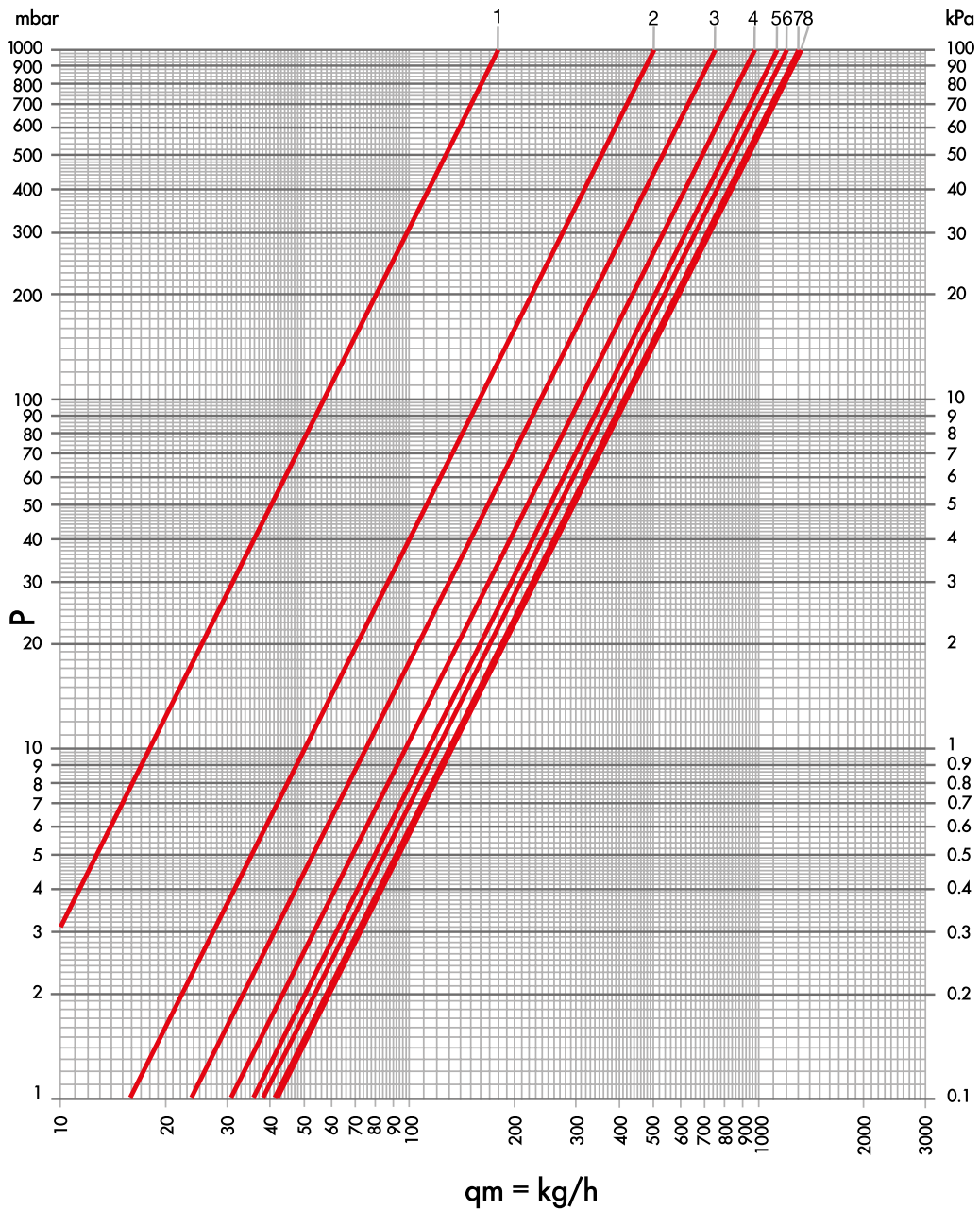

ARTICOLI	N. GIRI	Kvs	POS
DS 22 DS 26 DS 32 DS 39 DS 32/A DS 39/A	1	0.18	1
	1+1/2	0.50	2
	2	0.75	3
	2+1/2	0.97	4
	3	1.12	5
	3+1/2	1.20	6
	4	1.30	7
	tutto aperto	1.31	8

DIAGRAMMA DI PORTATA DETENTORE

DETENTORE A SQUADRA

DN 20 3/4

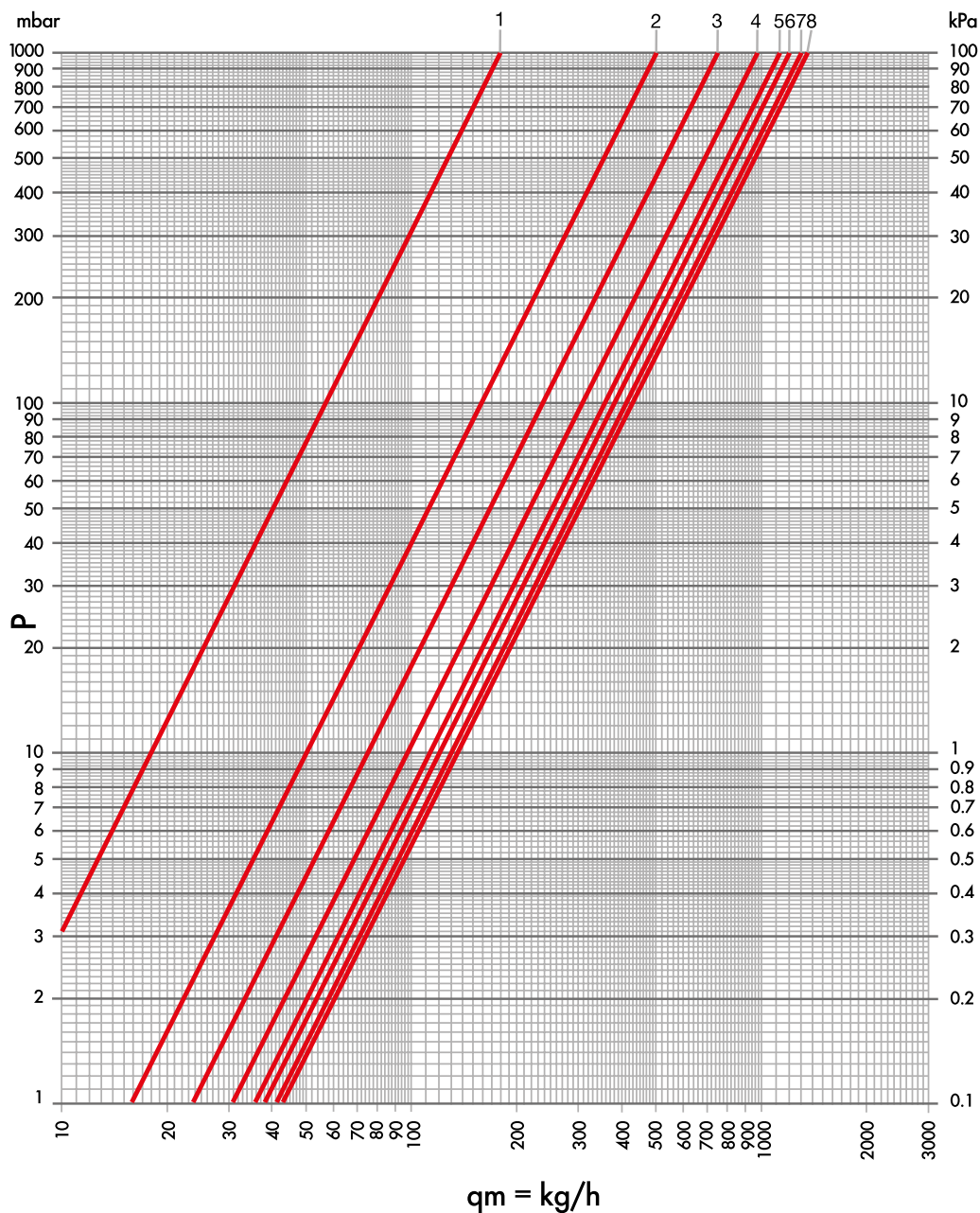

ARTICOLI	N. GIRI	Kvs	POS
DS 22 DS 26 DS 32 DS 39 DS 32/A DS 39/A	1	0.18	1
	1+1/2	0.50	2
	2	0.75	3
	2+1/2	0.97	4
	3	1.12	5
	3+1/2	1.20	6
	4	1.30	7
	tutto aperto	1.34	8

DIAGRAMMA DI PORTATA DETENTORE

DETENTORE DIRITTO

DN 10 3/8

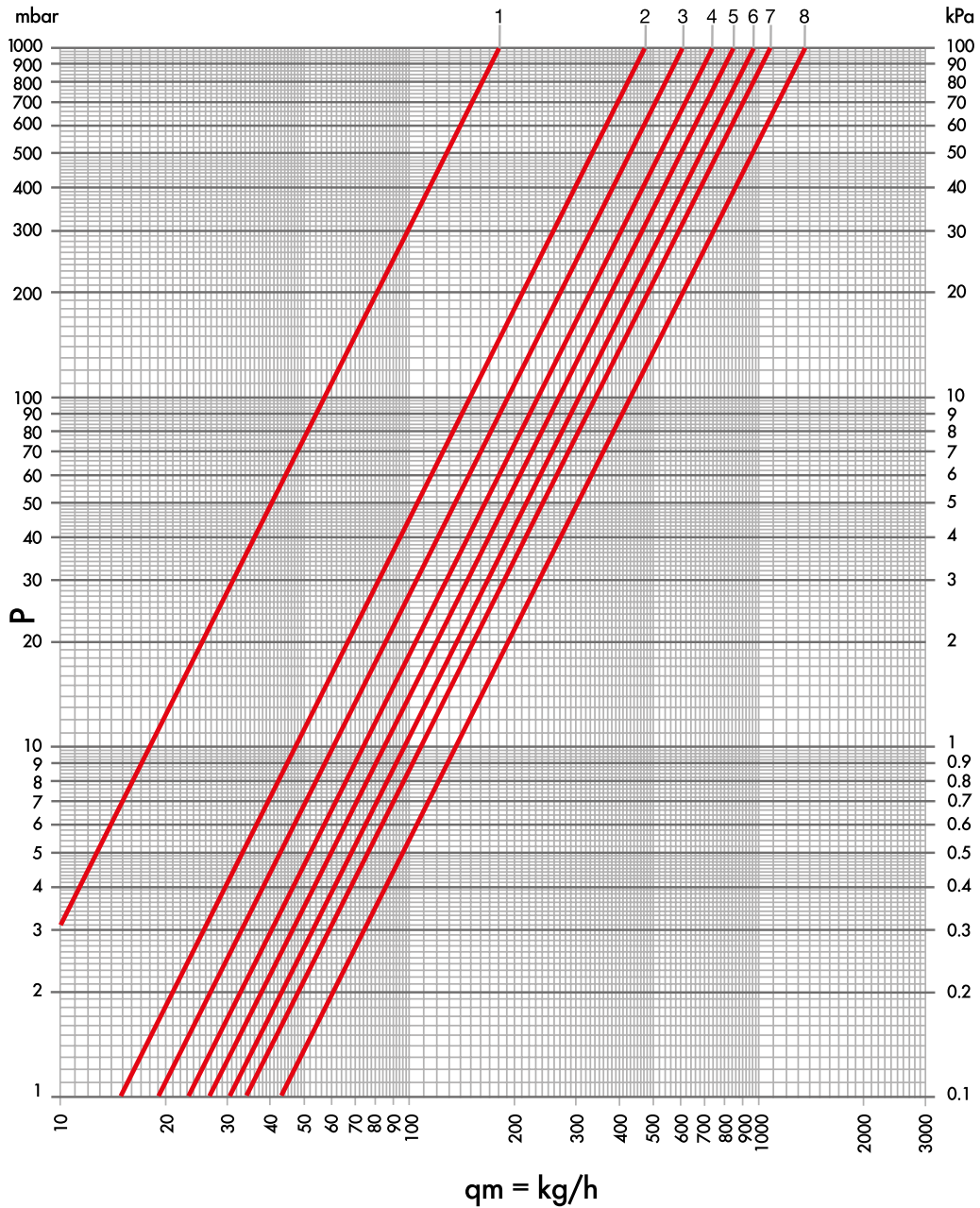

ARTICOLI	N. GIRI	Kvs	POS
DD 21 DD 25 DD 31 DD 38 DD 31/A DD 38/A	1	0.18	1
	1+1/2	0.47	2
	2	0.60	3
	2+1/2	0.73	4
	3	0.84	5
	3+1/2	0.95	6
	4	1.07	7
	tutto aperto	1.34	8

DIAGRAMMA DI PORTATA DETENTORE

DETENTORE DIRITTO

DN 15 1/2

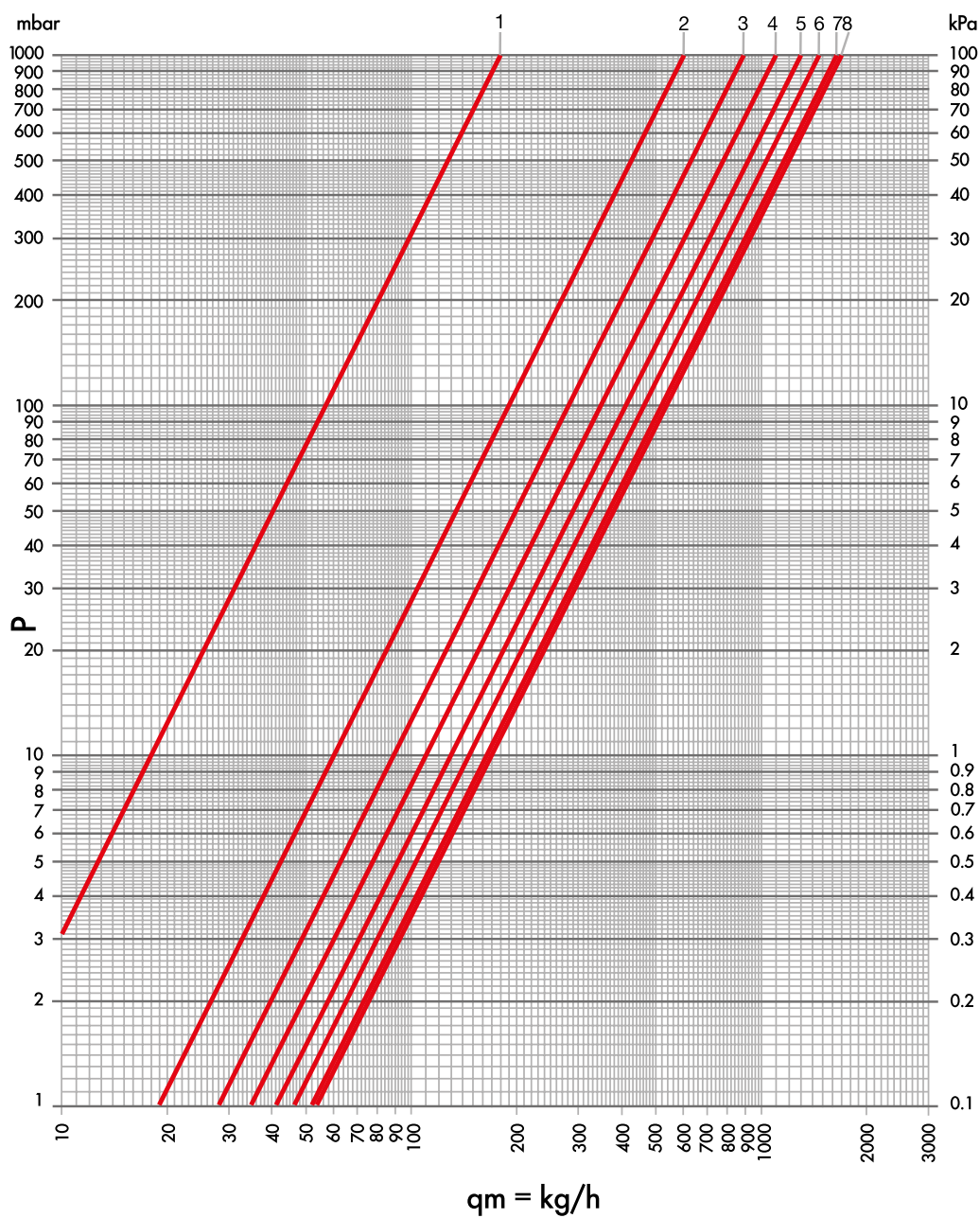

ARTICOLI	N. GIRI	Kvs	POS
DD 21 DD 25 DD 31 DD 38 DD 31/A DD 38/A	1	0.18	1
	1+1/2	0.60	2
	2	0.89	3
	2+1/2	1.10	4
	3	1.30	5
	3+1/2	1.46	6
	4	1.63	7
	tutto aperto	1.70	8

DIAGRAMMA DI PORTATA DETENTORE

DETENTORE DIRITTO

DN 20 3/4

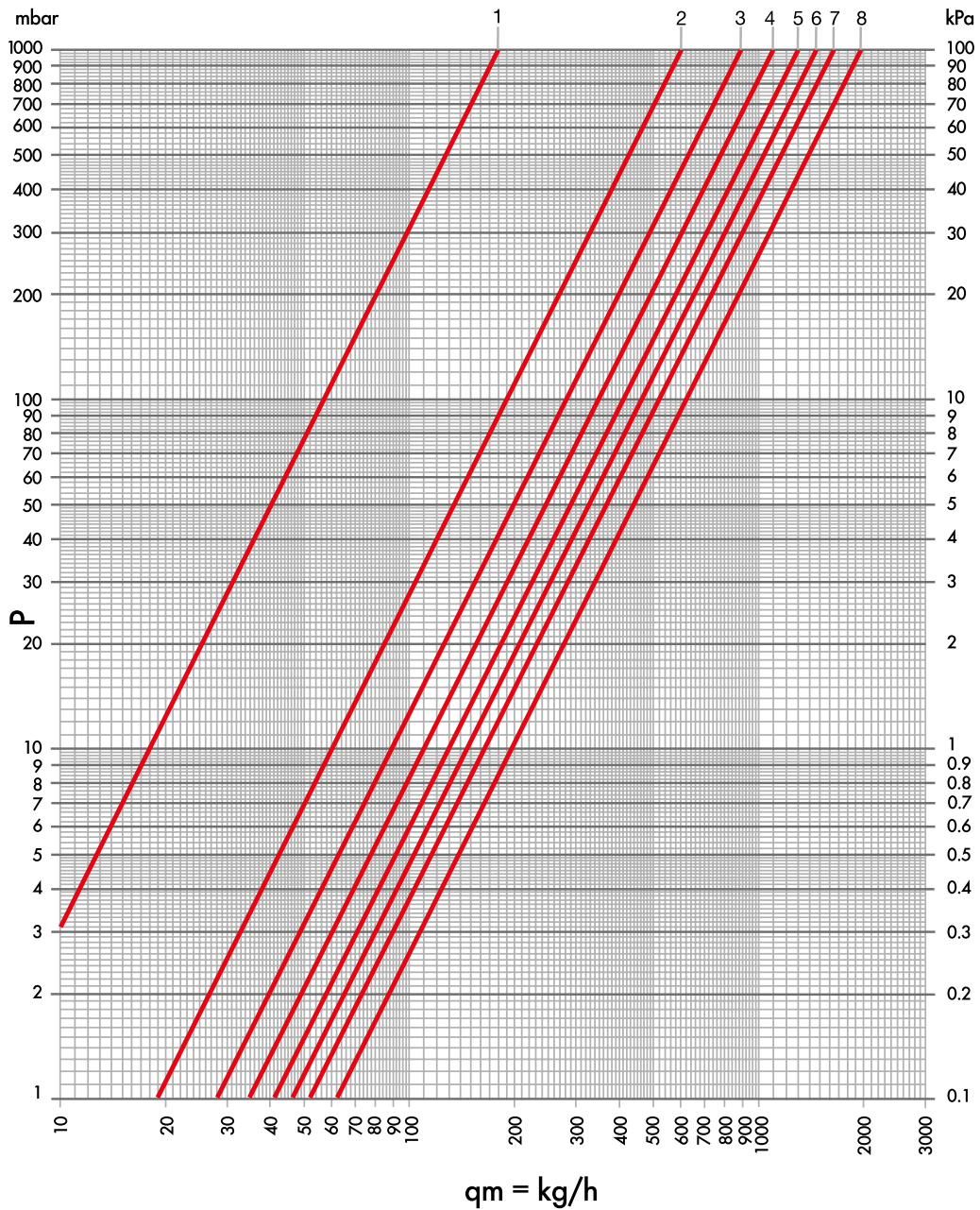

ARTICOLI	N. GIRI	Kvs	POS
DD 21 DD 25 DD 31 DD 38 DD 31/A DD 38/A	1	0.18	1
	1+1/2	0.60	2
	2	0.89	3
	2+1/2	1.10	4
	3	1.30	5
	3+1/2	1.46	6
	4	1.63	7
	tutto aperto	1.96	8



VALVOLE RADIATORE

1.3 / SERIE 30

SERIE 30 VALVOLE PER RADIATORE



Le valvole Serie 30 hanno un vitone che offre la possibilità di prerogolazione grazie ad un anello in acetalica sagomato. Il vitone termostatico permette la sostituzione di uno degli o-ring di tenuta sull'asta di comando senza che sia necessario svuotare l'impianto. Le valvole sono prodotte con finitura cromata.



I detentori serie 30 hanno la tenuta assicurata da un o-ring sull'otturatore e se necessario da un ulteriore o-ring tra il corpo e il tappo. La tenuta in chiusura con l'otturatore è assicurata da un o-ring e da una tenuta conica metallica. Tutti i detentori hanno la possibilità di regolare la portata limitando l'alzata dell'otturatore.



La valvola manuale Serie 30 utilizza un'asta fissa la cui tenuta è garantita da due o-rings. La tenuta in chiusura con l'otturatore è assicurata da un o-ring e da una tenuta conica metallica. L'apertura delle valvole e detentori deve essere effettuata con pressione differenziale inferiore a un 1 bar.

CARATTERISTICHE TECNICHE



DN

15



Max temperatura

120 °C



Max pressione

10 bar



Max pressione differenziale (valvole termostatiche)

0,6 bar



Max pressione differenziale

1 bar



Materiale

CW617N
UNI EN
12165:2016



Manopola

ABS cromato
ABS bianco
RAL 9016



Asta di comando

AISI 316



Collaudo

100%

ATTACCHI IMPIANTO



Tubo ferro
(valvole manuali)
G 1/2



Tubo rame
G 3/4 EK - TR 91/AC



Tubo plastica
G 3/4 EK - TP 98/C



Tubo multistrato
G 3/4 EK - TP 99/C

COLLEGAMENTO RADIATORE



filetto cilindrico con tenuta morbida
G 1/2

REGOLAZIONE DELLA PORTATA E REVERSE FLOW

Per regolare la massima portata della valvola si deve agire nel seguente modo:

- allineare la tacca di riferimento presente sull'asta in acciaio inox con una delle posizioni stampate sul corpo della valvola.

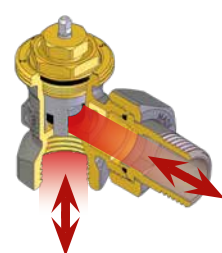
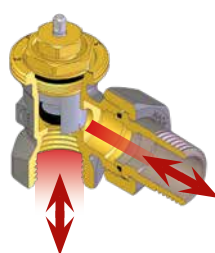
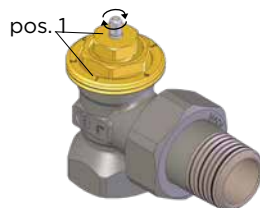

Tutte le valvole e i detentori vengono testati al 100% con prova di tenuta pneumatica a controllo elettronico.

Le caratteristiche del fluido dell'impianto devono essere conformi alla direttiva UNI 8065:2019.

ATTACCO TUBO FERRO



CHROME

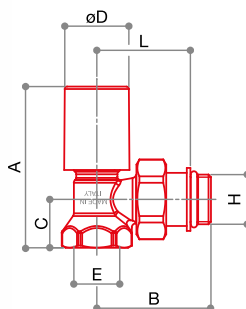

WHITE-CHROME

**KT 146**

Kit manuale squadra completo per collegamento ai termoarredi. Composto da due RS 146. Attacco tubo ferro.

Raccordi



CODICE	MISURA	FINITURA	A	B	C	D	E	F	G	H	L			
20822103	DN 15 1/2	CHROME	67	47	20	27	G 1/2	-	-	G 1/2	39	343	1	32
20822103CB	DN 15 1/2	WHITE-CHROME	67	47	20	27	G 1/2	-	-	G 1/2	39	343	1	32

ATTACCO TUBO RAME E TUBO PLASTICA G3/4 EUROCONO



CHROME

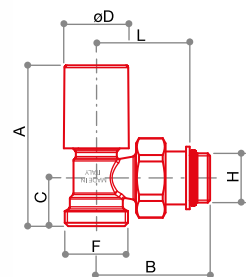

WHITE-CHROME

**KT 159/A**

Kit manuale squadra completo per collegamento ai termoarredi. Composto da due RS 159/A. Attacco tipo G 3/4 eurocono.

Raccordi



CODICE	MISURA	FINITURA	A	B	C	D	E	F	G	H	L			
20842703	DN 15 1/2	CHROME	67	47	20	27	-	G 3/4 EK	-	G 1/2	39	340	1	32
20842703CB	DN 15 1/2	WHITE-CHROME	67	47	20	27	-	G 3/4 EK	-	G 1/2	39	340	1	32



CHROME



WHITE-CHROME

KT 2509/A

Kit termostatico squadra completo per collegamento ai termoarredi. Composto da: RS 2509/A + DS 89/A. Attacco tipo G 3/4 eurocono.

Raccordi



CODICE	MISURA	FINITURA			
20742703	DN 15 1/2	CHROME	380	1	32
20742703CB	DN 15 1/2	WHITE-CHROME	380	1	32



CHROME



WHITE-CHROME

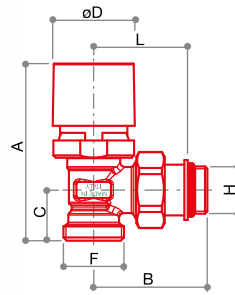

RS 2509/A

Valvola radiatore a squadra termostattizzabile o elettrocomandabile con volantino di comando manuale a semplice regolazione. Attacco tipo G 3/4 eurocono.

Raccordi



CODICE	MISURA	FINITURA	A	B	C	D	E	F	G	H	L			
20722703	DN 15 1/2	CHROME	77	49	22	36	-	G 3/4 EK	-	G 1/2	41	203	10	80
20722703CB	DN 15 1/2	WHITE-CHROME	77	49	22	36	-	G 3/4 EK	-	G 1/2	41	203	10	80



CHROME



WHITE-CHROME

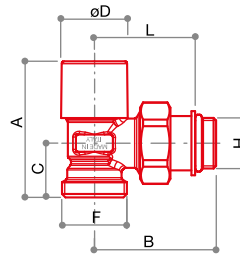

DS 89/A

Detentore di regolazione a squadra. Attacco tipo G 3/4 eurocono.

Raccordi



CODICE	MISURA	FINITURA	A	B	C	D	E	F	G	H	L			
20162703	DN 15 1/2	CHROME	55	49	22	27	-	G 3/4 EK	-	G 1/2	41	168	10	80
20162703CB	DN 15 1/2	WHITE-CHROME	55	49	22	27	-	G 3/4 EK	-	G 1/2	41	168	10	80

DIAGRAMMA DI PORTATA VALVOLE

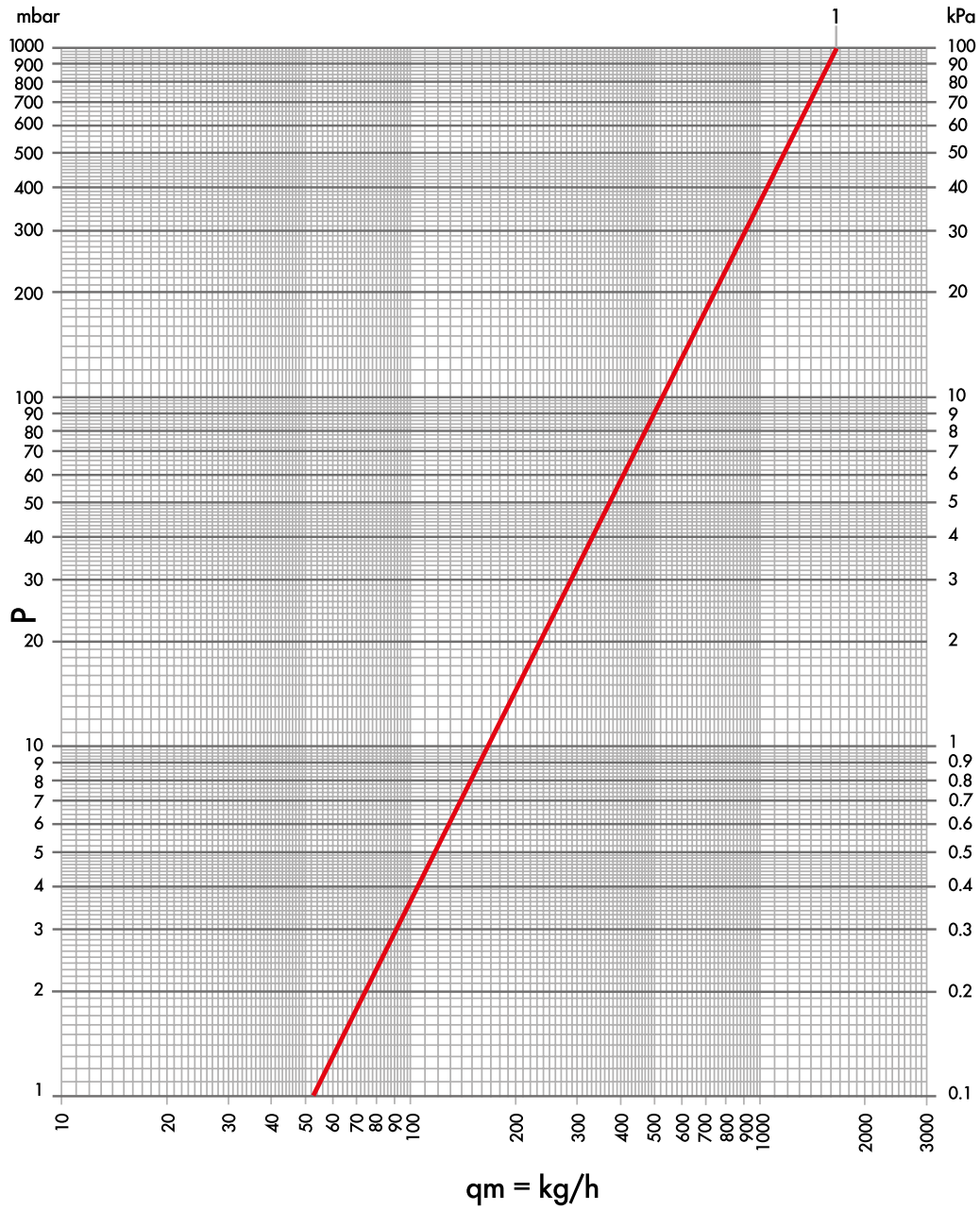

ARTICOLI	Kv	POS
RS 159/A 1/2	1,65	1

DIAGRAMMA DI PORTATA VALVOLE

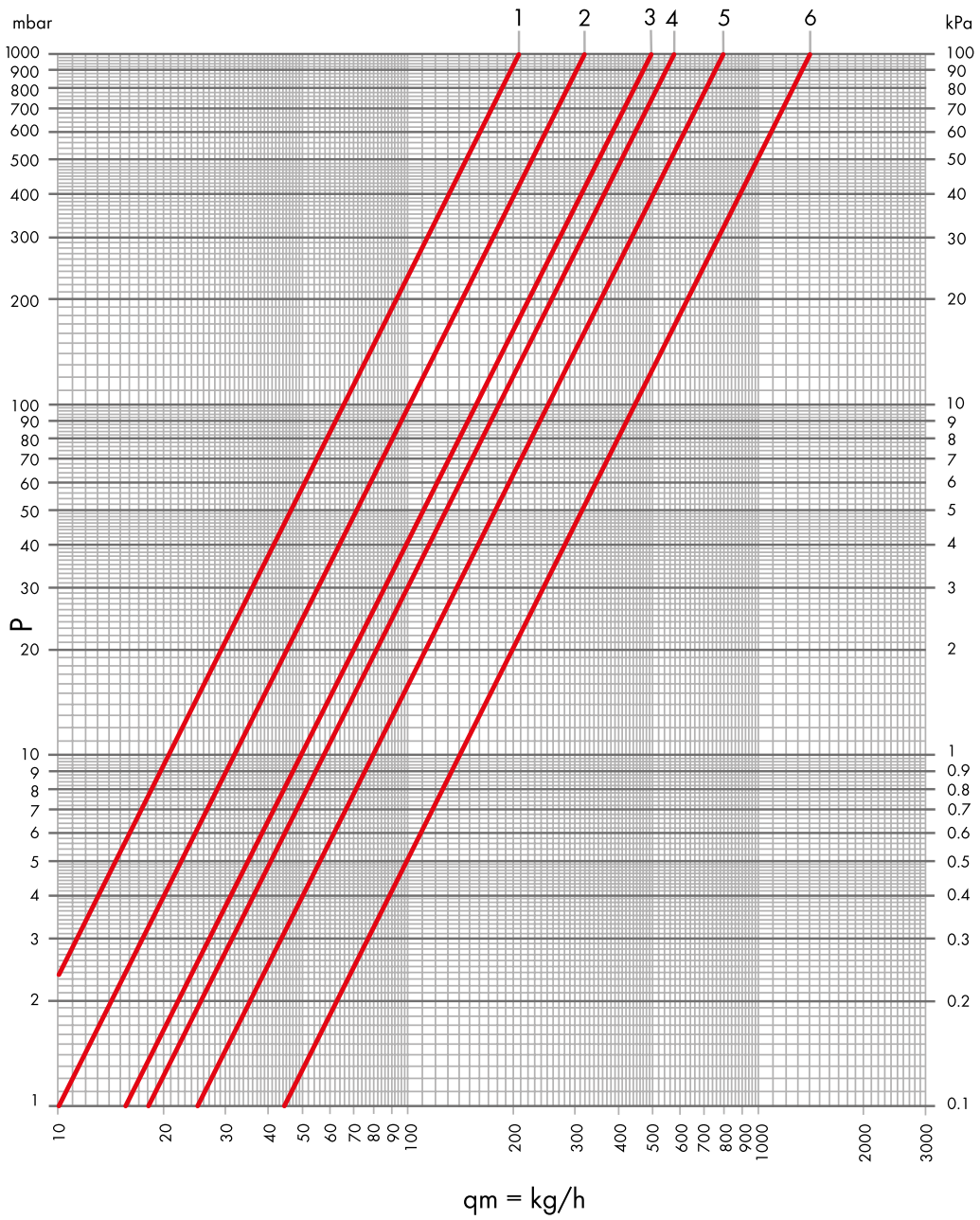

ARTICOLI	Kv	Kv Δt 1 °C	Kv Δt 2 °C	POS
RS 2509/A	0,10	0,07	0,07	1
	0,32	0,2	0,25	2
	0,49	0,24	0,36	3
	0,57	0,24	0,37	4
	0,79	0,24	0,40	5
	1,39	0,32	0,55	6

DIAGRAMMA DI PORTATA DETENTORE

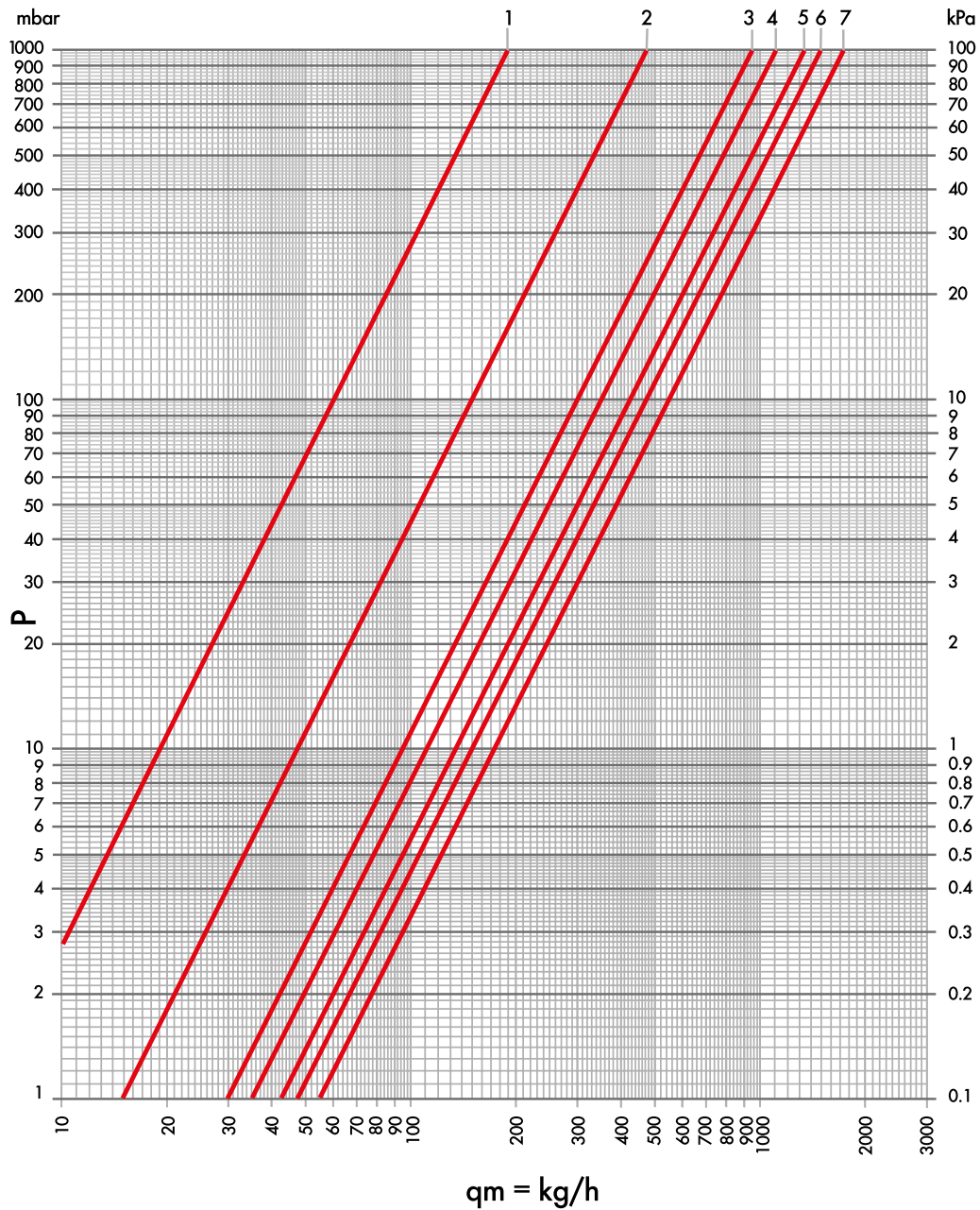

ARTICOLI	N. GIRI	Kv	POS
DS 89/A	1	0,19	1
	1+1/2	0,48	2
	2	0,71	3
	2+1/2	0,92	4
	3	1,06	5
	3+1/2	1,18	6
	tutto aperto	1,29	7



VALVOLE RADIATORE

1.4 / SERIE 50th

SERIE 50th

VALVOLE PER RADIATORE



Le valvole serie 50th hanno un vitone che offre la possibilità di preregolazione grazie ad un anello in acetilica sagomato. Il vitone termostatico permette la sostituzione di uno degli o-ring di tenuta sull'asta di comando senza che sia necessario svuotare l'impianto.



I detentori serie 50th hanno la tenuta assicurata da un o-ring sull'otturatore e se necessario da un ulteriore o-ring tra il corpo e il tappo. La tenuta in chiusura con l'otturatore è assicurata da un o-ring e da una tenuta conica metallica. Tutti i detentori hanno la possibilità di regolare la portata limitando l'alzata dell'otturatore.



La valvola manuale serie 50th utilizza un'asta fissa la cui tenuta è garantita da due o-rings. La tenuta in chiusura con l'otturatore è assicurata da una guarnizione piatta. L'apertura delle valvole e detentori deve essere effettuata con pressione differenziale inferiore a un 1 bar.

CARATTERISTICHE TECNICHE



DN

15



Max temperatura

120 °C



Max pressione

10 bar



Max pressione differenziale (valvole termostatiche)

0,6 bar



Max pressione differenziale

1 bar



Materiale

CW617N
UNI EN
12165:2016



Manopola

ABS cromato
ABS bianco
RAL 9016



Asta di comando

AISI 316

ATTACCHI IMPIANTO

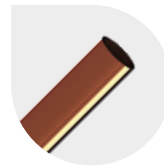

Tubo rame
G 3/4 EK - TR 91/AC

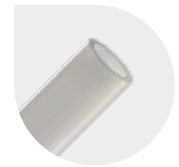

Tubo plastica
G 3/4 EK - TP 98/C



Tubo multistrato
G 3/4 EK - TP 99/C

COLLEGAMENTO RADIATORE



filetto cilindrico con tenuta morbida
G 1/2

FINITURA



chrome



white-chrome



white

COME SELEZIONARE LE VALVOLE COASSIALI CORRETTE

KIT TERMOSTATICO COASSIALE DESTRA



Detentore sinistro

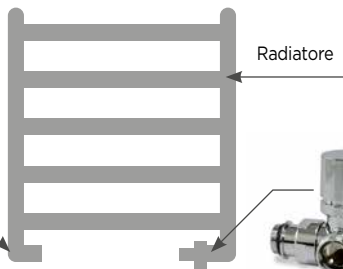

Radiatore



Valvola termostatica o manuale destra

KIT TERMOSTATICO COASSIALE SINISTRA



Valvola termostatica o manuale sinistra

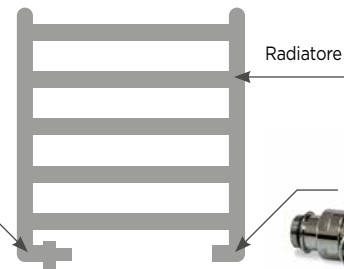

Radiatore



Detentore destro

Le caratteristiche del fluido dell'impianto devono essere conformi alla direttiva UNI 8065:2019.

REGOLAZIONE DELLA PORTATA

Per regolare la massima portata della valvola si deve agire nel seguente modo:

- allineare la tacca di riferimento presente sull'asta in acciaio inox con una delle posizioni stampate sul corpo della valvola.

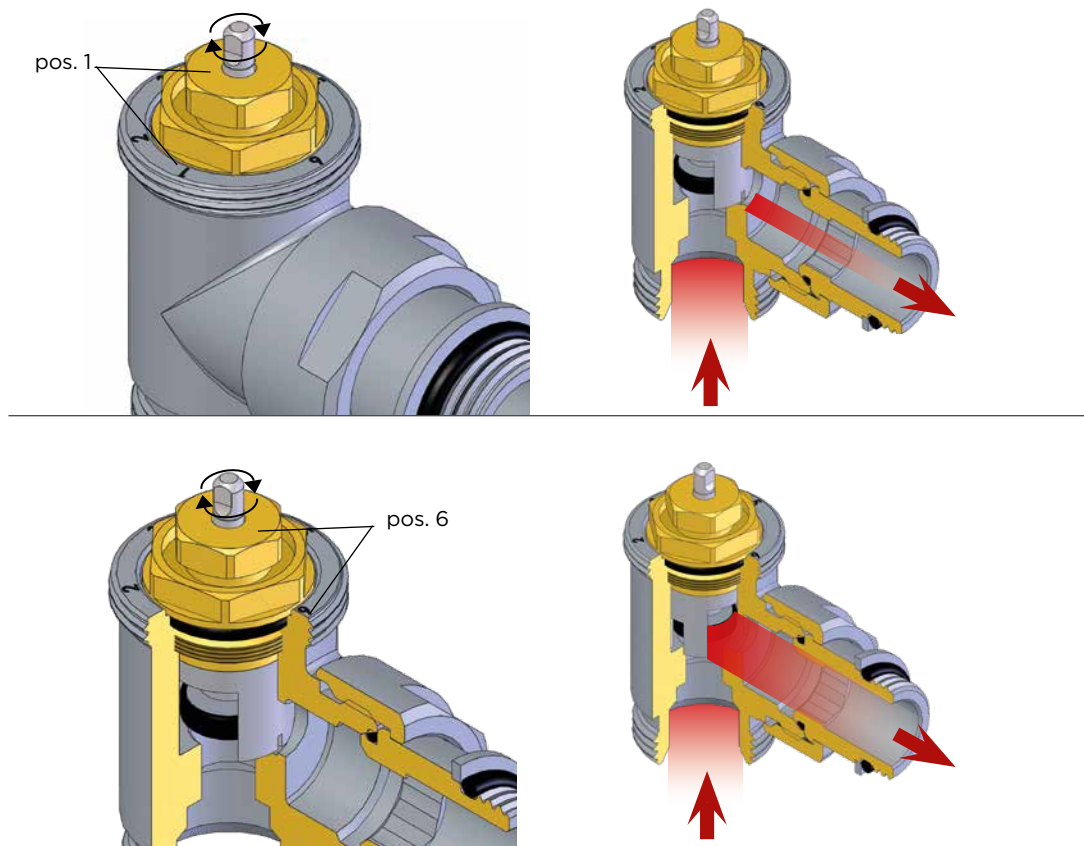

TENUTA SULLO STELO

Il sistema di tenuta può essere facilmente sostituito senza svuotare l'impianto:

- svitare la ghiera con testa esagonale con una chiave a stella da 13 mm;

- togliere l'o-ring "art. 582 - cod. 3424602", pulire l'asta in inox e inserire un nuovo o-ring "art. 582";
- montare la ghiera avvitando a fondo.



SOSTITUZIONE DEL VITONE

Grazie all'art. CH 111 - cod. 67822719 il vitone può essere sostituito senza svuotare l'impianto e con questo in funzione.

KIT TERMOSTATICI: ATTACCO TUBO RAME E TUBO PLASTICA G3/4 EUROCONO



CHROME



WHITE-CHROME



WHITE

KT 259/A

Kit termostatico squadra completo per collegamento ai termoarredi. Composto da: RS 259/A + DS 79/A + TT 3000. Attacco tipo eurocono.

CODICE	MISURA	FINITURA						
14702703	DN 15 1/2	CHROME	TR 91/AC	TP 98/C	TP 99/C	603	1	12
14702703CB	DN 15 1/2	WHITE-CHROME	TR 91/AC	TP 98/C	TP 99/C	604	1	12
14702703B	DN 15 1/2	WHITE	TR 91/AC	TP 98/C	TP 99/C	604	1	12



CHROME



WHITE-CHROME



WHITE

KT 258/A

Kit termostatico diritto completo per collegamento ai termoarredi. Composto da: RD 258/A + DD 78/A + TT 3000. Attacco tipo eurocono.

CODICE	MISURA	FINITURA						
14902703	DN 15 1/2	CHROME	TR 91/AC	TP 98/C	TP 99/C	663	1	12
14902703CB	DN 15 1/2	WHITE-CHROME	TR 91/AC	TP 98/C	TP 99/C	664	1	12
14902703B	DN 15 1/2	WHITE	TR 91/AC	TP 98/C	TP 99/C	664	1	12



CHROME



WHITE-CHROME



WHITE

KT 269/A

Kit termostatico coassiale destra completo per collegamento ai termoarredi. Composto da: RCD 269/A + DCS 33/A + TT 3000. Attacco tipo eurocono.

CODICE	MISURA	FINITURA						
14772703	DN 15 1/2	CHROME	TR 91/AC	TP 98/C	TP 99/C	655	1	12
14772703CB	DN 15 1/2	WHITE-CHROME	TR 91/AC	TP 98/C	TP 99/C	658	1	12
14772703B	DN 15 1/2	WHITE	TR 91/AC	TP 98/C	TP 99/C	658	1	12



CHROME



WHITE-CHROME



WHITE

KT 273/A

Kit termostatico coassiale sinistra completo per collegamento ai termoarredi. Composto da: RCS 273/A + DCD 29/A + TT 3000. Attacco tipo eurocono.

CODICE	MISURA	FINITURA						
14792703	DN 15 1/2	CHROME	TR 91/AC	TP 98/C	TP 99/C	655	1	12
14792703CB	DN 15 1/2	WHITE-CHROME	TR 91/AC	TP 98/C	TP 99/C	658	1	12
14792703B	DN 15 1/2	WHITE	TR 91/AC	TP 98/C	TP 99/C	658	1	12



CHROME



WHITE-CHROME



WHITE

KT 2059/A

Kit termostatico squadra completo per collegamento ai termoarredi. Composto da: RS 2059/A + DS 79/A. Attacco tipo eurocono.

CODICE	MISURA	FINITURA						
14742703	DN 15 1/2	CHROME	TR 91/AC	TP 98/C	TP 99/C	503	1	12
14742703CB	DN 15 1/2	WHITE-CHROME	TR 91/AC	TP 98/C	TP 99/C	507	1	12
14742703B	DN 15 1/2	WHITE	TR 91/AC	TP 98/C	TP 99/C	507	1	12

Kit con raccordi inclusi.

CODICE	MISURA	FINITURA			
14010001	DN 15 1/2	CHROME	503	1	12
14010001CB	DN 15 1/2	WHITE-CHROME	507	1	12
14010001B	DN 15 1/2	WHITE	507	1	12

	Raccordo	Codice	Misura
2x	TR 91/AC	67761200C	12 mm
2x	TR 91/AC	67761400C	14 mm
2x	TP 99/C	67861612C	16x2



Raccordi per tubo rame



Raccordi per tubo plastica



Raccordi per tubo multistrato



Raccordi: capitolo 7



Accessori: capitolo 1.A



CHROME



WHITE-CHROME



WHITE

KT 2058/A

Kit termostatico diritto completo per collegamento ai termoarredi. Composto da: RD 2058/A + DD 78/A. Attacco tipo eurocono.

CODICE	MISURA	FINITURA						
14942703	DN 15 1/2	CHROME	TR 91/AC	TP 98/C	TP 99/C	565	1	12
14942703CB	DN 15 1/2	WHITE-CHROME	TR 91/AC	TP 98/C	TP 99/C	567	1	12
14942703B	DN 15 1/2	WHITE	TR 91/AC	TP 98/C	TP 99/C	567	1	12



CHROME



WHITE-CHROME



WHITE

KT 2069/A

Kit termostatico coassiale destra completo per collegamento ai termoarredi. Composto da: RCD 2069/A + DCS 33/A. Attacco tipo eurocono.

CODICE	MISURA	FINITURA						
14812703	DN 15 1/2	CHROME	TR 91/AC	TP 98/C	TP 99/C	557	1	12
14812703CB	DN 15 1/2	WHITE-CHROME	TR 91/AC	TP 98/C	TP 99/C	561	1	12
14812703B	DN 15 1/2	WHITE	TR 91/AC	TP 98/C	TP 99/C	561	1	12

Kit con raccordi inclusi.

CODICE	MISURA	FINITURA			
14010002	DN 15 1/2	CHROME	503	1	12
14010002CB	DN 15 1/2	WHITE-CHROME	507	1	12
14010002B	DN 15 1/2	WHITE	507	1	12

Raccordo	Codice	Misura
2x TR 91/AC	67761200C	12 mm
2x TR 91/AC	67761400C	14 mm
2x TP 99/C	67861612C	16x2



CHROME



WHITE-CHROME



WHITE

KT 2073/A

Kit termostatico coassiale sinistra completo per collegamento ai termoarredi. Composto da: RCS 2073/A + DCD 29/A. Attacco tipo eurocono.

CODICE	MISURA	FINITURA						
14832703	DN 15 1/2	CHROME	TR 91/AC	TP 98/C	TP 99/C	557	1	12
14832703CB	DN 15 1/2	WHITE-CHROME	TR 91/AC	TP 98/C	TP 99/C	561	1	12
14832703B	DN 15 1/2	WHITE	TR 91/AC	TP 98/C	TP 99/C	561	1	12

Kit con raccordi inclusi.

CODICE	MISURA	FINITURA			
14010003	DN 15 1/2	CHROME	503	1	12
14010003CB	DN 15 1/2	WHITE-CHROME	507	1	12
14010003B	DN 15 1/2	WHITE	507	1	12

	Raccordo	Codice	Misura
2x	TR 91/AC	67761200C	12 mm
2x	TR 91/AC	67761400C	14 mm
2x	TP 99/C	67861612C	16x2

KIT MANUALI: ATTACCO TUBO RAME E TUBO PLASTICA G3/4 EUROCONO

CHROME



WHITE-CHROME



WHITE

KT 59/A

Kit manuale squadra completo per collegamento ai termoarredi. Composto da: RS 59/A + DS 79/A. Attacco tipo eurocono.

CODICE	MISURA	FINITURA						
14622703	DN 15 1/2	CHROME	TR 91/AC	TP 98/C	TP 99/C	502	1	12
14622703CB	DN 15 1/2	WHITE-CHROME	TR 91/AC	TP 98/C	TP 99/C	507	1	12
14622703B	DN 15 1/2	WHITE	TR 91/AC	TP 98/C	TP 99/C	507	1	12

Kit con raccordi inclusi.

CODICE	MISURA	FINITURA			
14010004	DN 15 1/2	CHROME	503	1	12
14010004CB	DN 15 1/2	WHITE-CHROME	507	1	12
14010004B	DN 15 1/2	WHITE	507	1	12

	Raccordo	Codice	Misura
2x	TR 91/AC	67761200C	12 mm
2x	TR 91/AC	67761400C	14 mm
2x	TP 99/C	67861612C	16x2



Raccordi per tubo rame



Raccordi per tubo plastica



Raccordi per tubo multistrato



Raccordi: capitolo 7



Accessori: capitolo 1.A



CHROME



WHITE-CHROME



WHITE

KT 69/A

Kit manuale coassiale destra completo per collegamento ai termoarredi.
Composto da: RCD 69/A + DCS 33/A.
Attacco tipo eurocono.

CODICE	MISURA	FINITURA						
14692703	DN 15 1/2	CHROME	TR 91/AC	TP 98/C	TP 99/C	561	1	12
14692703CB	DN 15 1/2	WHITE-CHROME	TR 91/AC	TP 98/C	TP 99/C	564	1	12
14692703B	DN 15 1/2	WHITE	TR 91/AC	TP 98/C	TP 99/C	564	1	12

Kit con raccordi inclusi.

CODICE	MISURA	FINITURA			
14010005	DN 15 1/2	CHROME	503	1	12
14010005CB	DN 15 1/2	WHITE-CHROME	507	1	12
14010005B	DN 15 1/2	WHITE	507	1	12

	Raccordo	Codice	Misura
2x	TR 91/AC	67761200C	12 mm
2x	TR 91/AC	67761400C	14 mm
2x	TP 99/C	67861612C	16x2



CHROME



WHITE-CHROME



WHITE

KT 73/A

Kit manuale coassiale sinistra completo per collegamento ai termoarredi.
Composto da: RCS 73/A + DCD 29/A.
Attacco tipo eurocono.

CODICE	MISURA	FINITURA						
14712703	DN 15 1/2	CHROME	TR 91/AC	TP 98/C	TP 99/C	561	1	12
14712703CB	DN 15 1/2	WHITE-CHROME	TR 91/AC	TP 98/C	TP 99/C	564	1	12
14712703B	DN 15 1/2	WHITE	TR 91/AC	TP 98/C	TP 99/C	564	1	12

Kit con raccordi inclusi.

CODICE	MISURA	FINITURA			
14010006	DN 15 1/2	CHROME	503	1	12
14010006CB	DN 15 1/2	WHITE-CHROME	507	1	12
14010006B	DN 15 1/2	WHITE	507	1	12

	Raccordo	Codice	Misura
2x	TR 91/AC	67761200C	12 mm
2x	TR 91/AC	67761400C	14 mm
2x	TP 99/C	67861612C	16x2



CHROME



WHITE-CHROME



WHITE

KT 58/A

Kit manuale diritto completo per collegamento ai termoarredi.
Composto da: RD 58/A + DD 78/A.
Attacco tipo eurocono.

CODICE	MISURA	FINITURA						
14822703	DN 15 1/2	CHROME	TR 91/AC	TP 98/C	TP 99/C	566	1	12
14822703CB	DN 15 1/2	WHITE-CHROME	TR 91/AC	TP 98/C	TP 99/C	570	1	12
14822703B	DN 15 1/2	WHITE	TR 91/AC	TP 98/C	TP 99/C	570	1	12

VALVOLE TERMOSTATIZZABILI CON PREREGOLAZIONE: ATTACCO TUBO RAME E TUBO PLASTICA G3/4 EUROCONO



CHROME

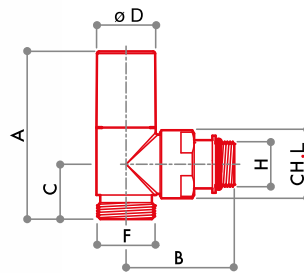

WHITE-CHROME

**RS 259/A**

Valvola radiatore a squadra termostattizzabile o elettrocomandabile con cappuccio di protezione.
Attacco tipo eurocono.

Raccordi



CODICE	MISURA	FINITURA	A	B	C	D	E	F	G	H	L			
14202703	DN 15 1/2	CHROME	67	50	25	37	-	G 3/4EK	-	G 1/2	28	264	5	60
14202703CB	DN 15 1/2	WHITE-CHROME	67	50	25	37	-	G 3/4EK	-	G 1/2	28	265	5	60



CHROME

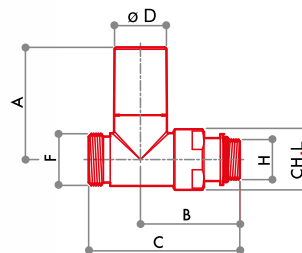

WHITE-CHROME

**RD 258/A**

Valvola radiatore diritta termostattizzabile o elettrocomandabile con cappuccio di protezione.
Attacco tipo eurocono.

Raccordi



CODICE	MISURA	FINITURA	A	B	C	D	E	F	G	H	L			
14402703	DN 15 1/2	CHROME	48	51	78	37	-	G 3/4EK	-	G 1/2	28	292	5	60
14402703CB	DN 15 1/2	WHITE-CHROME	48	51	78	37	-	G 3/4EK	-	G 1/2	28	293	5	60



Raccordi per tubo rame



Raccordi per tubo plastica



Raccordi per tubo multistrato



Raccordi: capitolo 7



Accessori: capitolo 1.A



CHROME



WHITE-CHROME

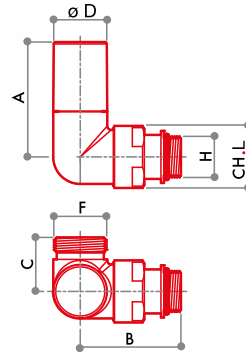

RCD 269/A

Valvola radiatore coassiale destra termostattabile o elettrocomandabile con cappuccio di protezione. Attacco tipo eurocono.

Raccordi



CODICE	MISURA	FINITURA	A	B	C	D	E	F	G	H	L			
14272703	DN 15 1/2	CHROME	48	51	27	37	-	G3/4EK	-	G1/2	28	287	5	60
14272703CB	DN 15 1/2	WHITE-CHROME	48	51	27	37	-	G3/4EK	-	G1/2	28	289	5	60



CHROME



WHITE-CHROME

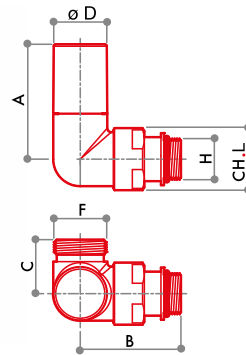

RCS 273/A

Valvola radiatore coassiale sinistra termostattabile o elettrocomandabile con cappuccio di protezione. Attacco tipo eurocono.

Raccordi



CODICE	MISURA	FINITURA	A	B	C	D	E	F	G	H	L			
14292703	DN 15 1/2	CHROME	48	51	27	37	-	G3/4EK	-	G1/2	28	287	5	60
14292703CB	DN 15 1/2	WHITE-CHROME	48	51	27	37	-	G3/4EK	-	G1/2	28	289	5	60



CHROME



WHITE-CHROME



WHITE

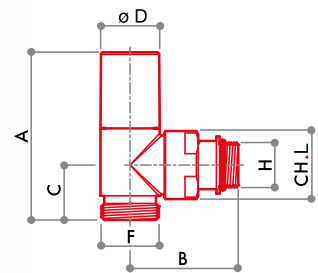

RS 2059/A

Valvola radiatore a squadra termostattabile o elettrocomandabile con volantino di comando manuale. Attacco tipo eurocono.

Raccordi



CODICE	MISURA	FINITURA	A	B	C	D	E	F	G	H	L			
14242703	DN 15 1/2	CHROME	83	50	25	35	-	G 3/4EK	-	G 1/2	28	278	5	60
14242703CB	DN 15 1/2	WHITE-CHROME	83	50	25	35	-	G 3/4EK	-	G 1/2	28	278	5	60
14242703B	DN 15 1/2	WHITE	83	50	25	35	-	G 3/4EK	-	G 1/2	28	278	5	60



CHROME



WHITE-CHROME



WHITE

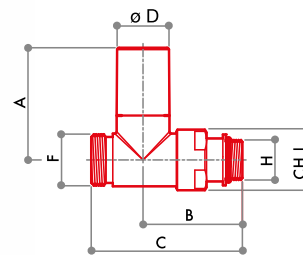

RD 2058/A

Valvola radiatore diritta termostattizzabile o elettrocomandabile con volantino di comando manuale. Attacco tipo eurocono.

Raccordi



CODICE	MISURA	FINITURA	A	B	C	D	E	F	G	H	L			
14442703	DN 15 1/2	CHROME	64	51	78	35	-	G 3/4EK	-	G 1/2	28	305	5	60
14442703CB	DN 15 1/2	WHITE-CHROME	64	51	78	35	-	G 3/4EK	-	G 1/2	28	306	5	60
14442703B	DN 15 1/2	WHITE	64	51	78	35	-	G 3/4EK	-	G 1/2	28	306	5	60



CHROME



WHITE-CHROME



WHITE

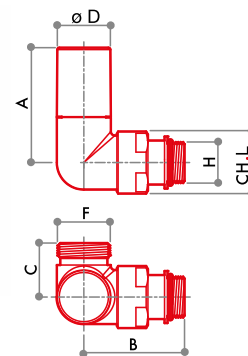

RCD 2069/A

Valvola radiatore coassiale destra termostattizzabile o elettrocomandabile con volantino di comando manuale. Attacco tipo eurocono.

Raccordi



CODICE	MISURA	FINITURA	A	B	C	D	E	F	G	H	L			
14312703	DN 15 1/2	CHROME	64	51	27	35	-	G3/4EK	-	G1/2	28	300	5	60
14312703CB	DN 15 1/2	WHITE-CHROME	64	51	27	35	-	G3/4EK	-	G1/2	28	303	5	60
14312703B	DN 15 1/2	WHITE	64	51	27	35	-	G3/4EK	-	G1/2	28	303	5	60



CHROME



WHITE-CHROME



WHITE

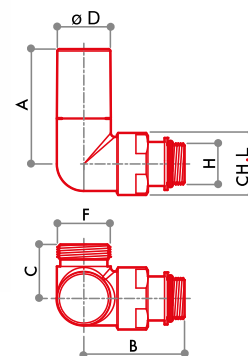

RCS 2073/A

Valvola radiatore coassiale sinistra termostattizzabile o elettrocomandabile con volantino di comando manuale. Attacco tipo eurocono.

Raccordi



CODICE	MISURA	FINITURA	A	B	C	D	E	F	G	H	L			
14332703	DN 15 1/2	CHROME	64	51	27	35	-	G3/4EK	-	G1/2	28	300	5	60
14332703CB	DN 15 1/2	WHITE-CHROME	64	51	27	35	-	G3/4EK	-	G1/2	28	303	5	60
14332703B	DN 15 1/2	WHITE	64	51	27	35	-	G3/4EK	-	G1/2	28	303	5	60



Raccordi per tubo rame



Raccordi per tubo plastica



Raccordi per tubo multistrato



Raccordi: capitolo 7



Accessori: capitolo 1.A

VALVOLE MANUALI: ATTACCO TUBO RAME E TUBO PLASTICA G3/4 EUROCONO



CHROME



WHITE-CHROME



WHITE

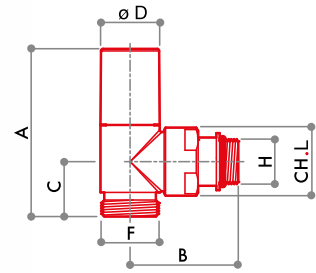

RS 59/A

Valvola radiatore a squadra a semplice regolazione. Attacco tipo eurocono.

Raccordi



CODICE	MISURA	FINITURA	A	B	C	D	E	F	G	H	L			
14122703	DN 15 1/2	CHROME	77	50	25	27	-	G 3/4EK	-	G 1/2	28	278	5	60
14122703CB	DN 15 1/2	WHITE-CHROME	77	50	25	27	-	G 3/4EK	-	G 1/2	28	278	5	60
14122703B	DN 15 1/2	WHITE	77	50	25	27	-	G 3/4EK	-	G 1/2	28	278	5	60



CHROME



WHITE-CHROME



WHITE

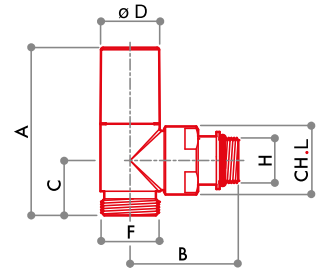

DS 79/A

Detentore di regolazione a squadra. Attacco tipo eurocono.

Raccordi



CODICE	MISURA	FINITURA	A	B	C	D	E	F	G	H	L			
14162703	DN 15 1/2	CHROME	62	50	25	27	-	G 3/4EK	-	G 1/2	28	224	5	60
14162703CB	DN 15 1/2	WHITE-CHROME	62	50	25	27	-	G 3/4EK	-	G 1/2	28	229	5	60
14162703B	DN 15 1/2	WHITE	62	50	25	27	-	G 3/4EK	-	G 1/2	28	229	5	60



CHROME



WHITE-CHROME



WHITE

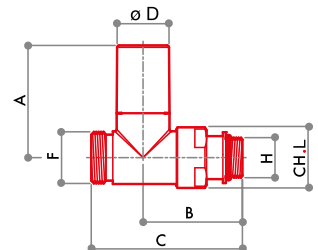

RD 58/A

Valvola radiatore diritta a semplice regolazione. Attacco tipo eurocono.

Raccordi



CODICE	MISURA	FINITURA	A	B	C	D	E	F	G	H	L			
14322703	DN 15 1/2	CHROME	58	51	78	27	-	G 3/4EK	-	G 1/2	28	305	5	60
14322703CB	DN 15 1/2	WHITE-CHROME	58	51	78	27	-	G 3/4EK	-	G 1/2	28	309	5	60
14322703B	DN 15 1/2	WHITE	58	51	78	27	-	G 3/4EK	-	G 1/2	28	309	5	60



CHROME



WHITE-CHROME



WHITE

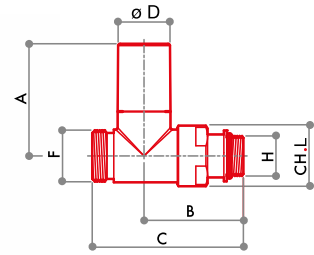

DD 78/A

Detentore di regolazione diritto.
Attacco tipo eurocono.

Raccordi



CODICE	MISURA	FINITURA	A	B	C	D	E	F	G	H	L			
14362703	DN 15 1/2	CHROME	42	51	78	27	-	G 3/4EK	-	G 1/2	28	260	5	60
14362703CB	DN 15 1/2	WHITE-CHROME	42	51	78	27	-	G 3/4EK	-	G 1/2	28	567	5	60
14362703B	DN 15 1/2	WHITE	42	51	78	27	-	G 3/4EK	-	G 1/2	28	567	5	60



CHROME



WHITE-CHROME



WHITE

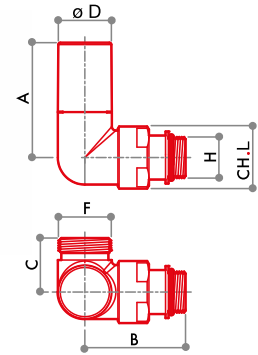

RCD 69/A

Valvola radiatore coassiale destra a semplice regolazione. Attacco tipo eurocono.

Raccordi



CODICE	MISURA	FINITURA	A	B	C	D	E	F	G	H	L			
14192703	DN 15 1/2	CHROME	58	51	27	27	-	G3/4EK	-	G1/2	28	304	5	60
14192703CB	DN 15 1/2	WHITE-CHROME	58	51	27	27	-	G3/4EK	-	G1/2	28	306	5	60
14192703B	DN 15 1/2	WHITE	58	51	27	27	-	G3/4EK	-	G1/2	28	306	5	60



CHROME



WHITE-CHROME



WHITE

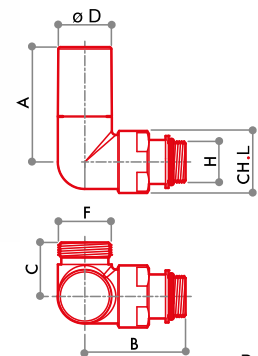

DCS 33/A

Detentore di regolazione coassiale sinistro. Attacco tipo eurocono.

Raccordi



CODICE	MISURA	FINITURA	A	B	C	D	E	F	G	H	L			
14252703	DN 15 1/2	CHROME	42	51	27	27	-	G3/4EK	-	G1/2	28	258	5	60
14252703CB	DN 15 1/2	WHITE-CHROME	42	51	27	27	-	G3/4EK	-	G1/2	28	258	5	60
14252703B	DN 15 1/2	WHITE	42	51	27	27	-	G3/4EK	-	G1/2	28	258	5	60



Raccordi per tubo rame



Raccordi per tubo plastica



Raccordi per tubo multistrato



Raccordi: capitolo 7



Accessori: capitolo 1.A



CHROME



WHITE-CHROME



WHITE

RCS 73/A

Valvola radiatore coassiale sinistra a semplice regolazione. Attacco tipo eurocono.

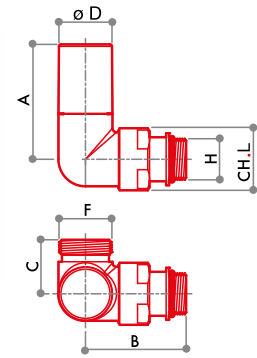

Raccordi



CODICE	MISURA	FINITURA	A	B	C	D	E	F	G	H	L	⊙	⊠	⊞
14212703	DN 15 1/2	CHROME	58	51	27	27	-	G3/4EK	-	G1/2	28	304	5	60
14212703CB	DN 15 1/2	WHITE-CHROME	58	51	27	27	-	G3/4EK	-	G1/2	28	306	5	60
14212703B	DN 15 1/2	WHITE	58	51	27	27	-	G3/4EK	-	G1/2	28	306	5	60



CHROME



WHITE-CHROME



WHITE

DCD 29/A

Detentore di regolazione coassiale destro. Attacco tipo eurocono.

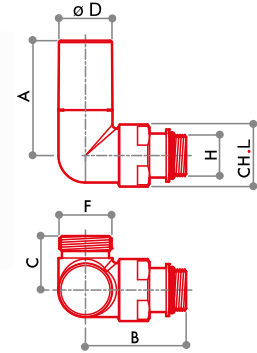

Raccordi



CODICE	MISURA	FINITURA	A	B	C	D	E	F	G	H	L	⊙	⊠	⊞
14232703	DN 15 1/2	CHROME	42	51	27	27	-	G3/4EK	-	G1/2	28	258	5	60
14232703CB	DN 15 1/2	WHITE-CHROME	42	51	27	27	-	G3/4EK	-	G1/2	28	258	5	60
14232703B	DN 15 1/2	WHITE	42	51	27	27	-	G3/4EK	-	G1/2	28	258	5	60

VALVOLE MONOTUBO BITUBO

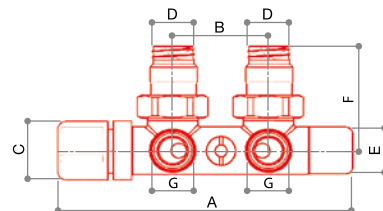

MT 2590/A

Valvola mono-bitubo termostattabile con volantino di comando manuale. Bypass regolabile. Attacco tipo eurocono.

Raccordi



CODICE	MISURA	FINITURA	A	B	C	D	E	F	G	⊙	⊠	⊞
14002703	DN 15 1/2	CHROME	153	50	34	G1/2	26	52	G3/4EK	657	1	10

TT 3000C

TESTA TERMOSTATICA



CARATTERISTICHE TECNICHE



Max temperatura
120 °C



Max pressione
10 bar



Max pressione
differenziale
0,6 bar

**Temperatura min. di regolazione
(pos. antigelo)**

Ts min 6 °C

**Temperatura max di regolazione
(pos. max)**

Ts max 30 °C (5)

Condizioni di risparmio

20 °C

**Campo di inalterabilità dell'elemento
termostatico**

-15 °C ÷ 60 °C

Temperatura di stoccaggio

-20 °C ÷ + 50 °C

Isteresi

C 0,4 k

Influenza della pressione

D 0,5 k

Influenza della temperatura dell'acqua

W 0,25 k

Tempo di risposta

Z 22 min.

Control Accuracy

CA 0,2 K.

ATTACCO VALVOLA



M 30 x 1,5

**PER MAGGIORI INFORMAZIONI
FARE RIFERIMENTO AL CAPITOLO
THERMOTEKNA**

CARATTERISTICHE COSTRUTTIVE

Le teste termostatiche sono costituite da un sensore riempito con un elemento ad alta espansibilità.

L'elemento, che si trova all'interno della manopola di regolazione o nel sensore a distanza, è in grado di dilatarsi o ridursi proporzionalmente all'aumento o alla diminuzione di temperatura ambiente, registrando anche minime variazioni.

Quando la temperatura circostante aumenta, l'elemento si espande e, attraverso il movimento assiale di spinta, influenza la posizione dell'otturatore, controllando così l'azione della valvola.

Con la chiusura e l'apertura della valvola è possibile regolare il flusso del fluido termovettore.

TESTA TERMOSTATICA CON COMANDO E SENSORE INCORPORATO



CHROME



WHITE-CHROME

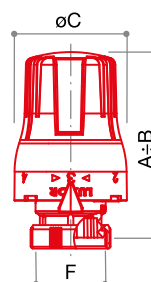

TT 3000

Testa termostatica con comando e sensore incorporato.

CODICE	MISURA	FINITURA	A	B	C	D	E	F	G	H	L			
69100000C	M30x1,5	CHROME	75	80	46,5	-	-	M30x1,5	-	-	-	110	1	100
69100000CB	M30x1,5	WHITE-CHROME	75	80	46,5	-	-	M30x1,5	-	-	-	110	1	100

DIAGRAMMA DI PORTATA VALVOLE

VALVOLE MANUALI

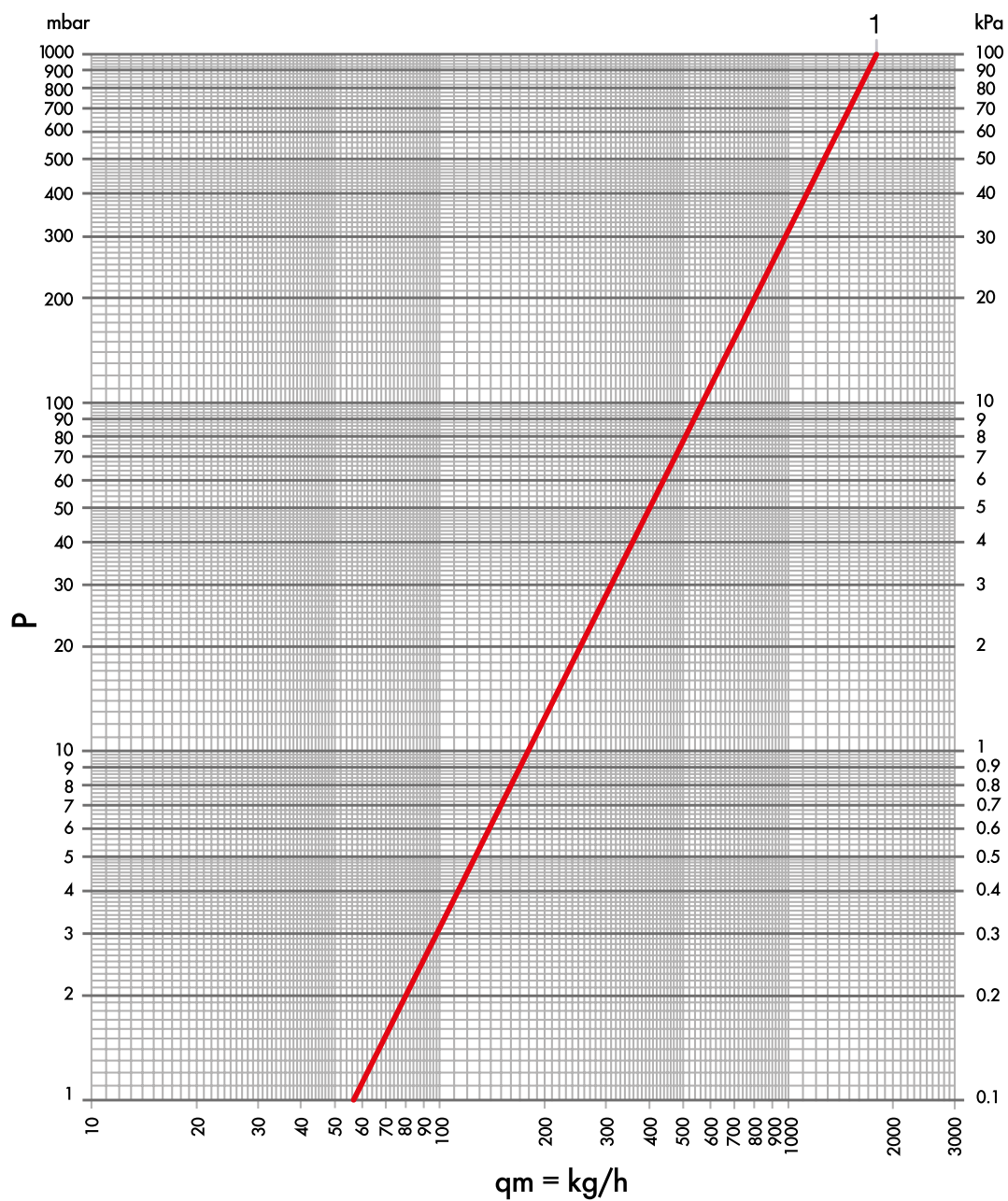

ARTICOLI	N. GIRI	Kv	POS
RD 58/A 1/2 RS 59/A 1/2 RCD 69/A 1/2 RCS 73/A 1/2	1	1,85	1

DIAGRAMMA DI PORTATA VALVOLE

VALVOLE THERMO

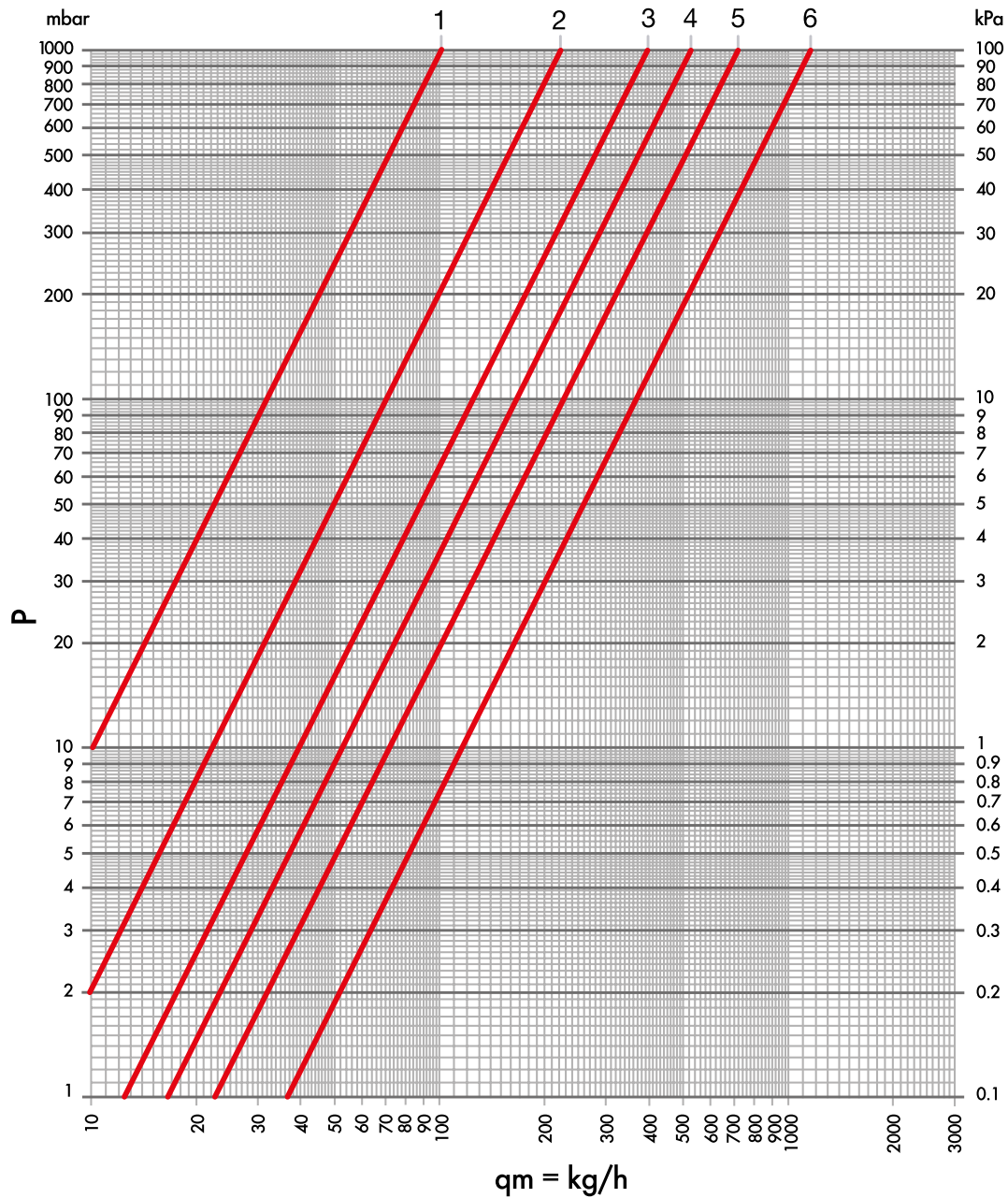

ARTICOLI	Kv	Kv Δt 1 °C	Kv Δt 2 °C	POS
	0,10	0,11	0,15	1
RD 258/A RS 259/A	0,22	0,16	0,25	2
RCD 269/A RCS 273/A	0,39	0,18	0,36	3
RD 2058/A RS 2059/A	0,52	0,18	0,37	4
RCD 2069/A RCS 2073/A	0,71	0,19	0,43	5
	1,25	0,20	0,50	6

DIAGRAMMA DI PORTATA DETENTORE

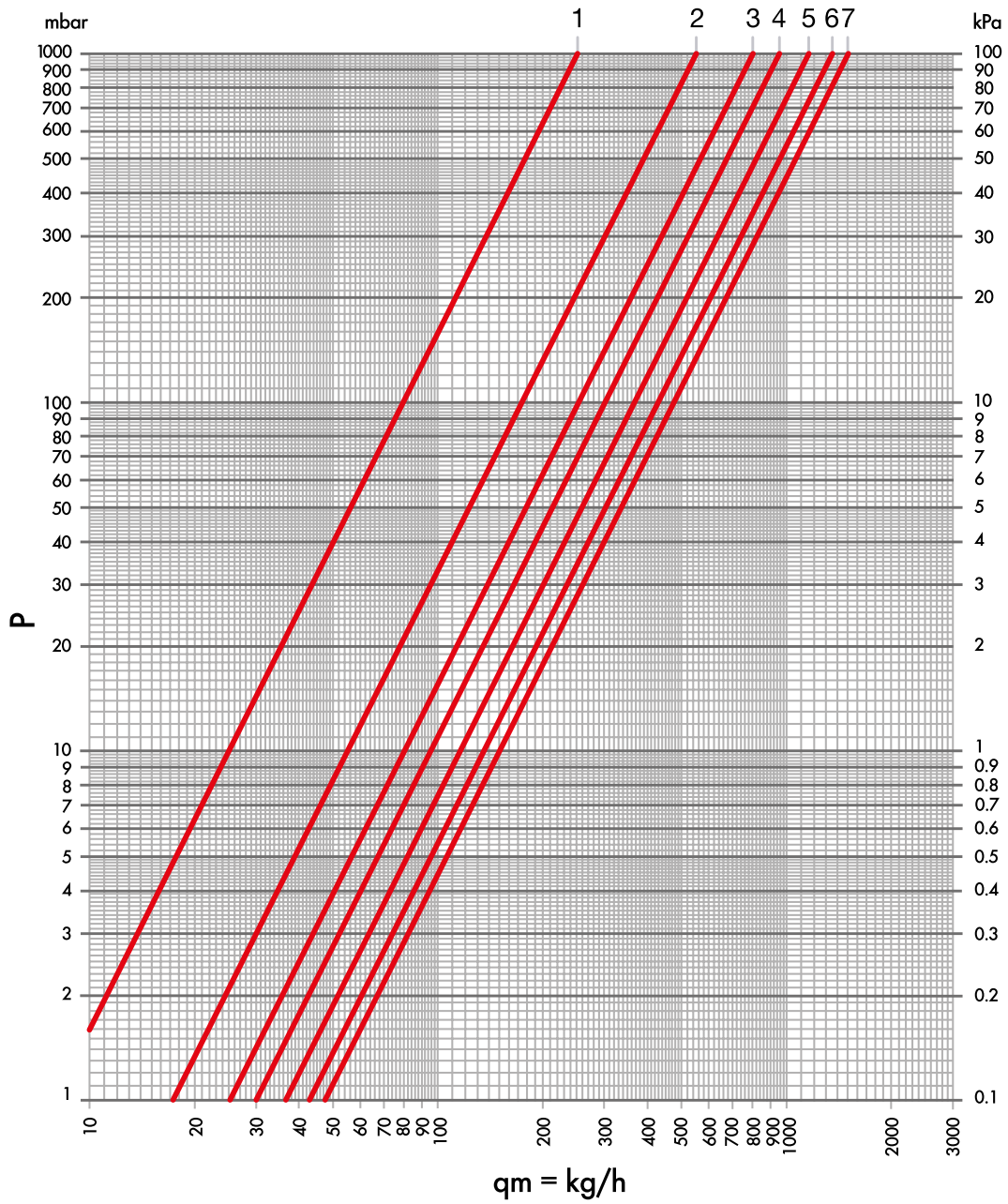

ARTICOLI	N. GIRI	Kv	POS
DD 78/A DS 79/A DCD 29/A DCS 33/A	1	0,25	1
	1+1/2	0,55	2
	2	0,80	3
	2+1/2	0,95	4
	3	1,15	5
	3+1/2	1,35	6
	tutto aperto	1,50	7



VALVOLE RADIATORE

1.5 / M-MT

M

VALVOLE MANUALI A 4 VIE PER IMPIANTI MONOTUBO



Le valvole monotubo utilizzano un'asta fissa la cui tenuta è garantita da un o-ring e da una guarnizione piana in teflon regolabile da una ghiera premistoppa in ottone. Le valvole sono prodotte con finitura nichelata.

CARATTERISTICHE TECNICHE



DN

15
20



Max temperatura

120 °C



Max pressione

10 bar



Max pressione differenziale

1 bar



Materiale

CW617N
UNI EN
12165:2016



Manopola

ABS bianco
RAL 9016



Sonda

Poliammide

ATTACCHI IMPIANTO

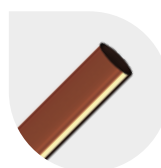

Tubo rame
W 24x19 - TR 91



Tubo plastica
W 24x19 - TP 95



Tubo multistrato
W 24x19 - TP 97

COLLEGAMENTO RADIATORE

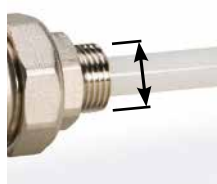

filetto cilindrico
G 1/2
G 3/4

INTERASSI



40 mm

SONDA

Le valvole a 4 vie serie M sono dotate di una sonda articolo M 523 in poliammide che permette loro di distribuire correttamente il flusso in corpi scaldanti lunghi fino a 50 cm. Nel caso non sia rispettata la freccia stampata sul corpo indicante la direzione del flusso, oppure in presenza di installazioni

con corpi scaldanti più lunghi di 50 cm, è necessario applicare la prolunga in poliammide articolo M 525 e deve essere tagliata in modo che l'altra estremità sia posta a 10 cm dalla fine del corpo scaldante.



Le caratteristiche del fluido dell'impianto devono essere conformi alla direttiva UNI 8065:2019.

VALVOLE MANUALI A 4 VIE PER IMPIANTI MONOTUBO M 87

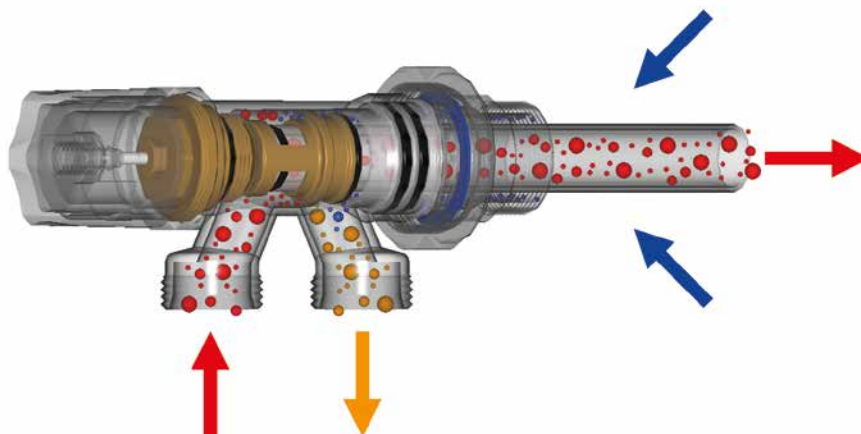

Luxor produce valvole manuali a 4 vie per impianti monotubo e bitubo in grado di soddisfare tutte le esigenze impiantistiche.

Tutte le valvole a 4 vie adottano una soluzione costruttiva che permette di avere l'ingresso e l'uscita del flusso da un unico attacco al corpo scaldante. Queste valvole devono essere installate sull'attacco inferiore del corpo scaldante.

Le valvole a 4 vie per impianti monotubo hanno lo scopo di:

- allacciare il corpo scaldante alle tubazioni dell'anello monotubo, che può essere in rame, plastica o tubo multistrato PEX-AL-PEX;
- permettere la regolazione della temperatura nell'ambiente, variando il flusso in ingresso nel corpo scaldante;

- intercettare il flusso in modo da permettere la manutenzione al corpo scaldante senza compromettere il funzionamento degli altri corpi scaldanti.

Il flusso in arrivo alla valvola è diviso in due parti: una parte entra nel corpo scaldante, l'altra attraverso il bypass prosegue verso il corpo scaldante successivo. Il vantaggio è che il flusso uscito dal corpo scaldante a bassa temperatura si miscela con il flusso che è passato attraverso il bypass a più alta temperatura, in questo modo il flusso che proseguirà verso il corpo scaldante successivo avrà una potenza termica superiore.

La valvola M 87 ha il bypass fisso, in posizione di massima apertura il 50% della portata dell'anello entra nel corpo scaldante.

VALVOLE MANUALI A 4 VIE PER IMPIANTI MONOTUBO E BITUBO M 88

La valvola M 88 in posizione di massima apertura non ha il bypass e il 100% della portata dell'anello entra nel corpo scaldante (vedi immagine).

Il bypass si apre progressivamente in proporzione alla chiusura dell'otturatore (vedi sotto).

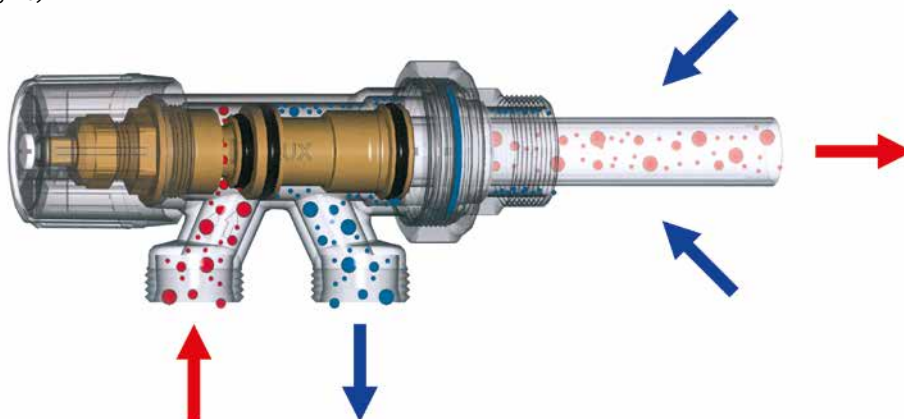

La valvola M 88 in posizione di chiusura ha il bypass al 100% della portata dell'anello, dunque non entra liquido nel corpo scaldante.

Le altre caratteristiche sono uguali alle valvole manuali M 87 per impianti monotubo.

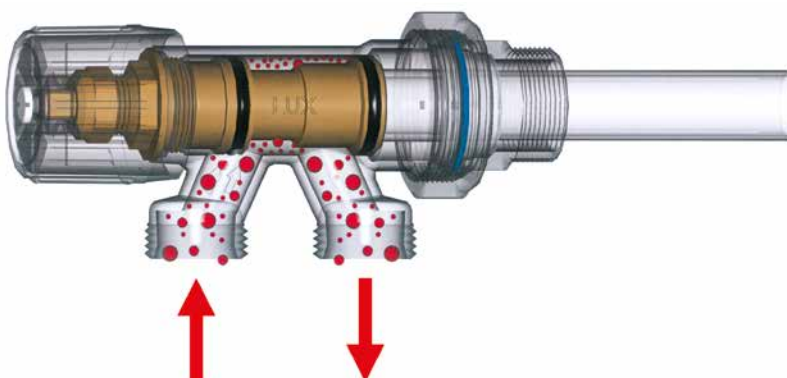

VALVOLE MANUALI VERTICALI A 4 VIE PER IMPIANTI MONOTUBO M 81-83-85

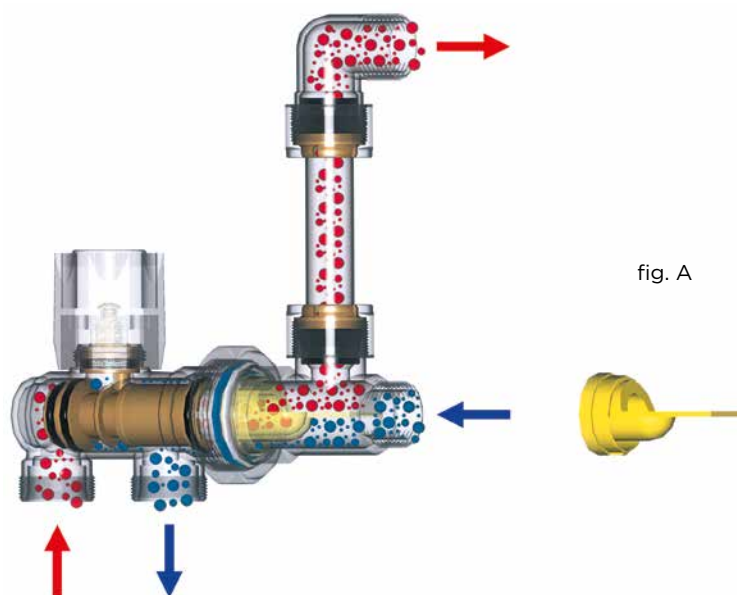

fig. A

Le valvole manuali verticali a 4 vie possono essere monotubo con un bypass al 50% della portata oppure bitubo al 100% della portata dell'anello. Le valvole devono essere collegate alla rete rispettando le frecce posizionate sul corpo. In questo modo le valvole sono in grado di riscaldare un corpo scaldante fino a 7-8 elementi. Nel caso non sia rispettato il verso del flusso o il corpo scaldante sia di dimensioni maggiori agli 8 elementi, nella valvola M 81 e M 83 deve essere installata la prolunga articolo M 525.

La prolunga deve essere tagliata in modo che l'altra estremità sia posta a 10 cm dalla fine del corpo scaldante. Nelle valvole M 85 e M 86 se non viene rispettato il verso del flusso bisogna girare il setto nel corpo del convogliatore in modo tale da far riprendere il giusto verso del flusso. Utilizzando il setto come in figura A il flusso deve entrare dall'attacco come raffigurato dalla freccia.

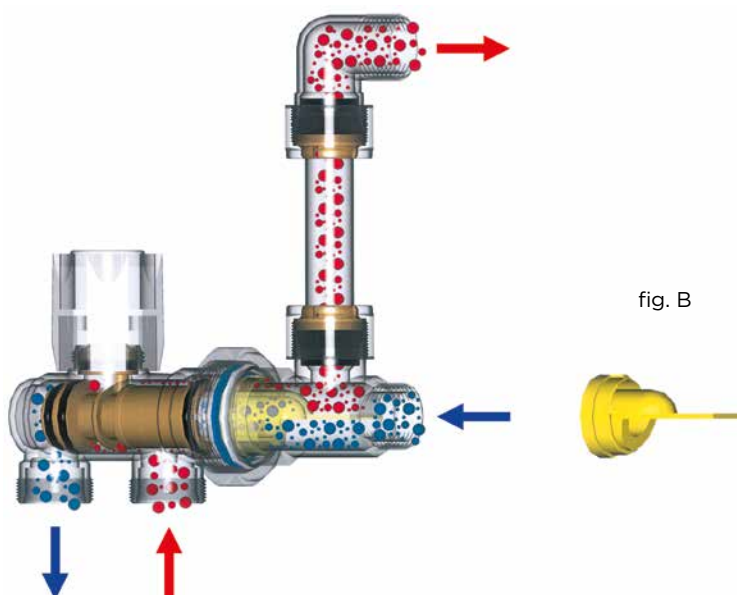
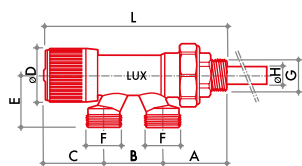

fig. B

Se in fase di installazione non dovesse essere rispettato il senso della freccia utilizzare il setto come in figura B.

**VALVOLE MANUALI A 4 VIE PER IMPIANTI MONOTUBO:
ATTACCO TUBO RAME E TUBO PLASTICA W24x19**
**M 87**

Valvola monotubo a semplice regolazione, manuale orizzontale. Portata massima al corpo scaldante: 50% della portata dell'anello. Attacchi tubo rame e tubo plastica.

Raccordi

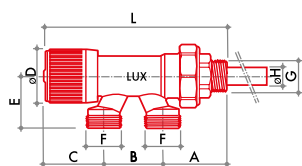

CODICE	MISURA	A	B	C	D	E	F	G	H	L			
68072100	DN 15 1/2	45	40	41	37	35	W24x19	G 1/2	12	126	360	5	40
68072700	DN 20 3/4	45	40	41	37	35	W24x19	G 3/4	16	126	358	5	40

**M 88**

Valvola monotubo a semplice regolazione, manuale orizzontale (per impianti bitubo). Portata massima al corpo scaldante: 100% della portata dell'anello. Attacchi tubo rame e tubo plastica.

Raccordi

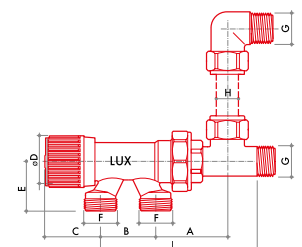

CODICE	MISURA	A	B	C	D	E	F	G	H	L			
68072101	DN 15 1/2	45	40	41	37	35	W24x19	G 1/2	12	126	366	5	40
68072701	DN 20 3/4	45	40	41	37	35	W24x19	G 3/4	16	126	363	5	40

**M 86**

Valvola monotubo diritta a semplice regolazione orizzontale, con convogliatore di flusso. Portata massima al corpo scaldante: 50% e 100% della portata dell'anello. Attacchi tubo rame e tubo plastica.

Raccordi

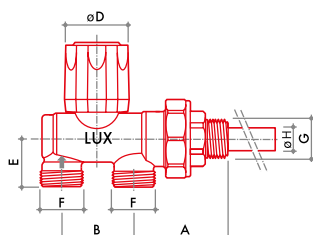

CODICE	MISURA	A	B	C	D	E	F	G	H	L			
68072102	DN 15 1/2 50%	52	40	41	37	35	W24x19	G 1/2	15	110	488	5	40
68072103	DN 15 1/2 100%	52	40	41	37	35	W24x19	G 1/2	15	110	490	5	40

**M 81**

Valvola monotubo a semplice regolazione, manuale verticale. Portata massima al corpo scaldante: 50% della portata dell'anello. Attacchi tubo rame e tubo plastica.

Raccordi



CODICE	MISURA	A	B	C	D	E	F	G	H	L			
68032101	DN 15 1/2	50	40	-	35	27	W24x19	G 1/2	12	-	344	5	40
68032701	DN 20 3/4	50	40	-	35	27	W24x19	G 3/4	16	-	346	5	40



Raccordi per tubo rame



Raccordi per tubo plastica



Raccordi per tubo multistrato



Raccordi: capitolo 7



Accessori: capitolo 1.A

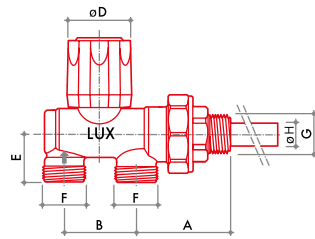

M 83

Valvola monotubo a semplice regolazione, manuale verticale. Portata massima al corpo scaldante: 100% della portata dell'anello. Attacchi tubo rame e tubo plastica.

Raccordi



CODICE	MISURA	A	B	C	D	E	F	G	H	L			
68042100	DN 15 1/2	50	40	-	35	27	W24x19	G 1/2	12	-	346	5	40
68042700	DN 20 3/4	50	40	-	35	27	W24x19	G 3/4	16	-	348	5	40

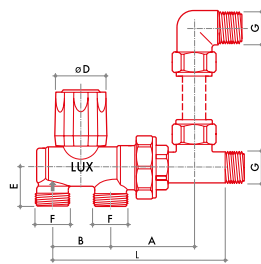

M 85

Valvola monotubo diritta a semplice regolazione, verticale con convogliatore di flusso. Portata massima al corpo scaldante: 50% e 100% della portata dell'anello. Attacchi tubo rame e tubo plastica.

Raccordi



CODICE	MISURA	A	B	C	D	E	F	G	H	L			
68042102	DN 15 1/2 50%	57	40	-	35	27	W24x19	G 1/2	15	114	552	5	40
68042103	DN 15 1/2 100%	57	40	-	35	27	W24x19	G 1/2	15	114	555	5	40

DIAGRAMMA DI PORTATA VALVOLE

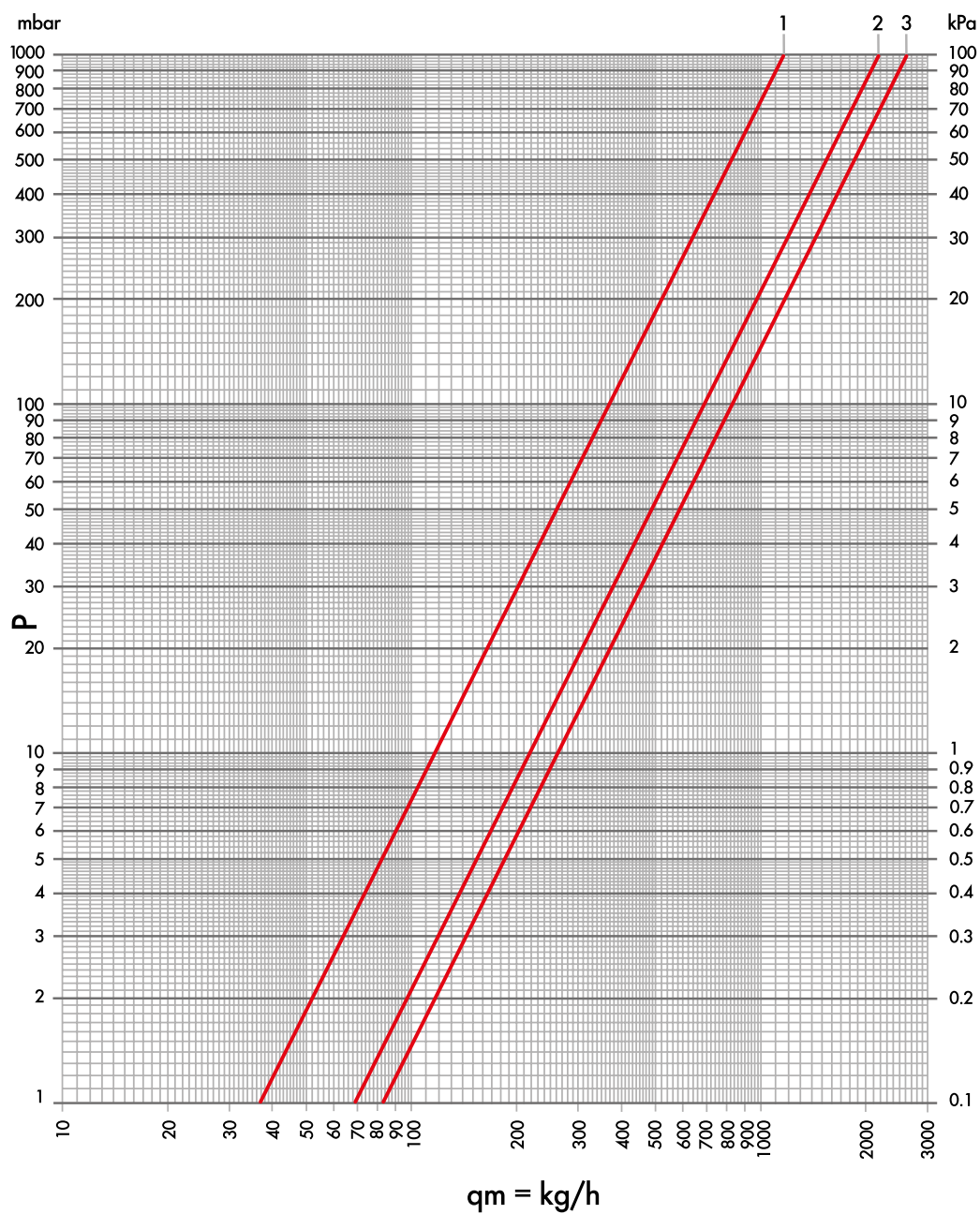

ARTICOLI	Kv	POS
M 88 1/2 M 88 3/4 M 86 1/2 100%	1.61	1
M 83 1/2 M 83 3/4 M 85 1/2 100%	2.16	2
M 87 1/2 M 87 3/4 M 86 1/2 50% M 81 1/2 M 81 3/4 M 85 1/2 50%	2.60	3

MT

VALVOLE TERMOSTATICHE A 4 VIE PER IMPIANTI MONOTUBO



Le valvole monotubo termostattizzabili, se equipaggiate con la testa termostatica e con un $\Delta t=2K$, consentono di alimentare il corpo scaldante con una portata pari al 35% della portata totale del circuito. Il vitone termostatico permette la so-

stituzione di uno degli o-ring di tenuta sull'asta di comando senza che sia necessario svuotare l'impianto. Le valvole sono prodotte con finitura nichelata.

CARATTERISTICHE TECNICHE



DN
15
20



Max temperatura
120 °C



Max pressione
10 bar



Max pressione differenziale
1 bar



Materiale
CW617N
UNI EN
12165:2016



Manopola
ABS bianco
RAL 9016



Asta di comando
AISI 316



Sonda
Poliammide

ATTACCHI IMPIANTO

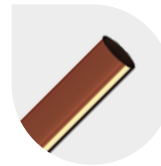

Tubo rame
W 24x19 - TR 91



Tubo plastica
W 24x19 - TP 95



Tubo multistrato
W 24x19 - TP 97

COLLEGAMENTO RADIATORE

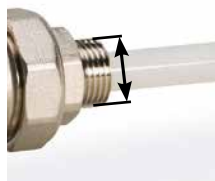

filetto cilindrico
G 1/2
G 3/4

INTERASSI

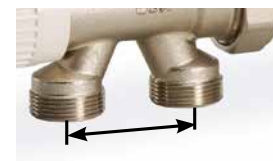

40 mm

SONDA

Le valvole a 4 vie serie M sono dotate di una sonda articolo M 523 in poliammide che permette loro di distribuire correttamente il flusso in corpi scaldanti lunghi fino a 50 cm. Nel caso non sia rispettata la freccia stampata sul corpo indicante la direzione del flusso, oppure in presenza

di installazioni con corpi scaldanti più lunghi di 50 cm, è necessario applicare la prolunga in poliammide articolo M 525 e deve essere tagliata in modo che l'altra estremità sia posta a 10 cm dalla fine del corpo scaldante.



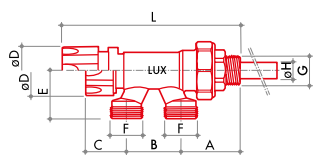

Le caratteristiche del fluido dell'impianto devono essere conformi alla direttiva UNI 8065:2019.

**VALVOLE TERMOSTATICHE A 4 VIE PER IMPIANTI MONOTUBO:
ATTACCO TUBO RAME E TUBO PLASTICA W24x19**
**MT 282**

Valvola monotubo termostattabile o elettrocomandabile con cappuccio di protezione. Portata massima al corpo scaldante: 35% della portata dell'anello ($\Delta t=2K$). Attacchi tubo rame e tubo plastica.

Raccordi



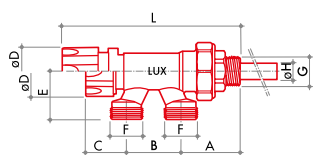

CODICE	MISURA	A	B	C	D	E	F	G	H	L			
68010021	DN 15 1/2	46	40	30	37	35	W24x19	G 1/2	12	115	353	5	40
68010027	DN 20 3/4	46	40	30	37	35	W24x19	G 3/4	16	115	351	5	40

**MT 2582**

Valvola monotubo termostattabile o elettrocomandabile con volantino di comando manuale articolo VT 2600. Portata massima al corpo scaldante: 35% della portata dell'anello ($\Delta t=2K$). Attacchi tubo rame e tubo plastica.

Raccordi



CODICE	MISURA	A	B	C	D	E	F	G	H	L			
68010121	DN 15 1/2	46	40	47	35	35	W24x19	G 1/2	12	133	360	5	40
68010127	DN 20 3/4	46	40	47	35	35	W24x19	G 3/4	16	133	360	5	40



Raccordi per tubo rame



Raccordi per tubo plastica



Raccordi per tubo multistrato



Raccordi: capitolo 7



Accessori: capitolo 1.A

DIAGRAMMA DI PORTATA VALVOLE

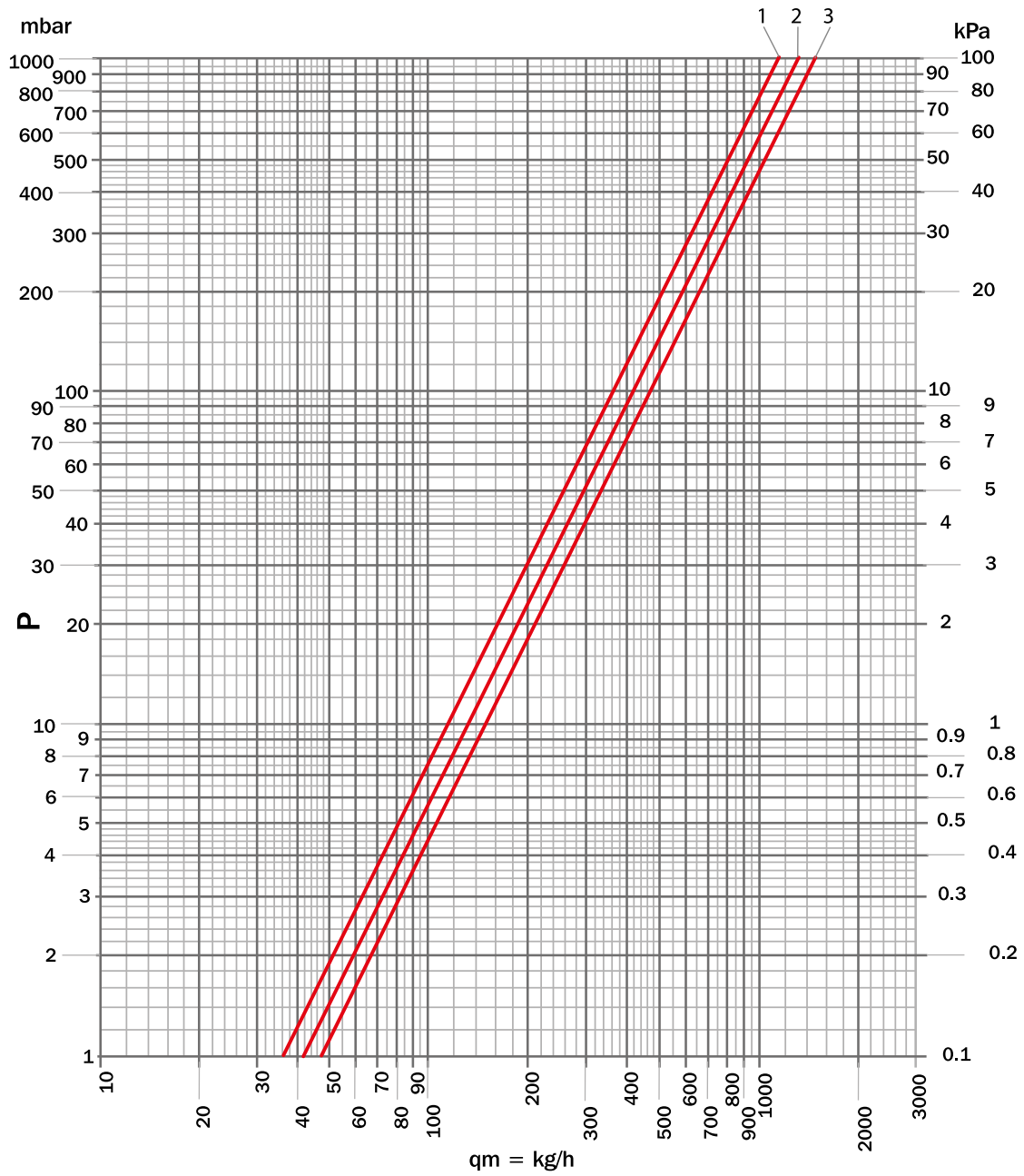

ARTICOLI	MISURA	RA %	N. GIRI	Kv	POS
MT 282	DN 15 1/2	0	chiuso	1,15	1
	DN 20 3/4			1,15	1
	DN 15 1/2	100	tutto aperto	1,30	2
	DN 20 3/4			1,45	3
MT 2582	DN 15 1/2	0	chiuso	1,15	1
	DN 20 3/4			1,15	1
	DN 15 1/2	100	tutto aperto	1,30	2
	DN 20 3/4			1,45	3

M

VALVOLE PER IMPIANTI MONOTUBO E BITUBO



Le valvole manuali serie M utilizzano un'asta fissa la cui tenuta è garantita da un o-ring e da una guarnizione piana in PTFE regolabile da una ghiera premistoppa in ottone. La tenuta in chiusura con l'otturatore è assicurata da un o-ring e da una tenuta conica metallica. Le valvole termostattizzabili

serie M hanno un vitone che offre la possibilità di prerogolazione grazie ad un anello in acetalica sagomato. Il vitone termostatico permette la sostituzione di uno degli o-ring di tenuta sull'asta di comando senza che sia necessario svuotare l'impianto. Le valvole sono prodotte con finitura nichelata.

CARATTERISTICHE TECNICHE



DN

15



Max temperatura

120 °C



Max pressione

10 bar



Max pressione differenziale
(valvole termostatiche)

0,6 bar



Max pressione differenziale

1 bar



Materiale

CW617N
UNI EN
12165:2016



Manopola

ABS bianco
RAL 9016



Asta di comando

AISI 316



Collaudo

100%

ATTACCHI IMPIANTO



Tubo ferro
G 1/2

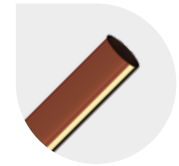

Tubo rame
W 24x19 - TR 91
G 3/4 EK - TR 91/A



Tubo plastica
W 24x19 - TP 95
G 3/4 EK - TP 98



Tubo multistrato
W 24x19 - TP 97
G 3/4 EK - TP 99

COLLEGAMENTO RADIATORE



filetto conico zigrinato
G 1/2

REGOLAZIONE DELLA PORTATA E REVERSE FLOW

Per regolare la massima portata della valvola si deve agire nel seguente modo:

- allineare la tacca di riferimento presente sull'asta in acciaio inox con una delle posizioni stampate sul corpo della valvola.

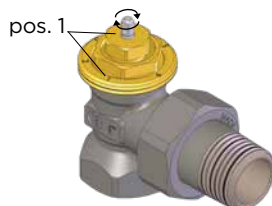

pos. 1

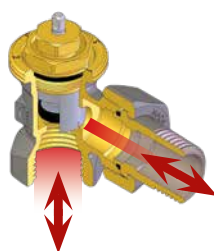

pos. 6

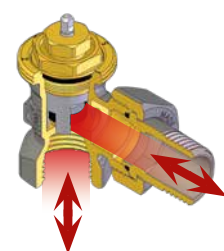

Le valvole termostatiche Luxor possono funzionare anche in condizione di flusso inverso. Grazie a questa caratteristica possono essere installate sia sulla mandata sia sul ritorno del radiatore fino ad una pressione differenziale di 0,6 bar.

Tutte le valvole e i detentori vengono testati al 100% con prova di tenuta pneumatica a controllo elettronico.

Le caratteristiche del fluido dell'impianto devono essere conformi alla direttiva UNI 8065:2019.

**VALVOLE PER IMPIANTI MONOTUBO E BITUBO:
ATTACCO TUBO RAME E TUBO PLASTICA W24x19**

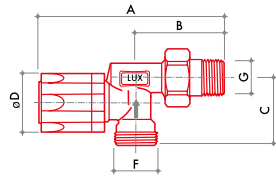

M 300

Valvola radiatore a corpo reverso a semplice regolazione. Attacco tubo rame e tubo plastica.

Raccordi



CODICE	MISURA	A	B	C	D	E	F	G	H	L			
13062100	DN 15 1/2	108	52	39	35	-	W24x19	R 1/2	-	-	215	10	80

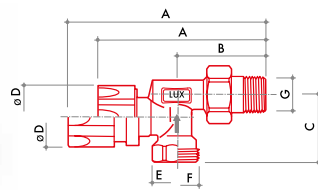

M 320

Valvola radiatore a corpo reverso termostattizzabile o elettrocomandabile con cappuccio di protezione. Attacco tubo rame e tubo plastica.

Raccordi



CODICE	MISURA	A	B	C	D	E	F	G	H	L			
13102100	DN 15 1/2	95	52	39	37	-	W24x19	R 1/2	-	-	207	10	80

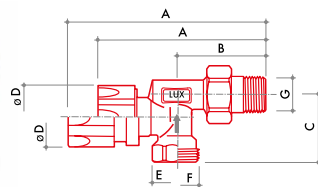

M 330

Valvola radiatore a corpo reverso termostattizzabile o elettrocomandabile con volantino di comando manuale. Attacco tubo rame e tubo plastica.

Raccordi



CODICE	MISURA	A	B	C	D	E	F	G	H	L			
13122100	DN 15 1/2	116	52	39	35	-	W24x19	R 1/2	-	-	215	10	80

VALVOLE PER IMPIANTI MONOTUBO E BITUBO: ATTACCO TUBO RAME E TUBO PLASTICA G3/4 EUROCONO

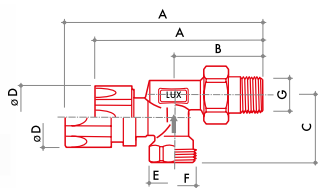

M 320/A

Valvola radiatore a corpo reverso termostattabile o elettrocomandabile con cappuccio di protezione. Attacchi tipo eurocono.

Raccordi



CODICE	MISURA	A	B	C	D	E	F	G	H	L			
13102721	DN 15 1/2	95	52	39	37	-	G 3/4 EK	R 1/2	-	-	210	10	80

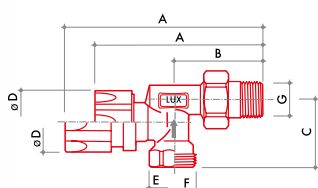

M 330/A

Valvola radiatore a corpo reverso termostattabile o elettrocomandabile con volantino di comando manuale. Attacchi tipo eurocono.

Raccordi



CODICE	MISURA	A	B	C	D	E	F	G	H	L			
13122721	DN 15 1/2	116	52	39	35	-	G 3/4 EK	R 1/2	-	-	217	10	80

VALVOLE PER IMPIANTI MONOTUBO E BITUBO: ATTACCO TUBO FERRO

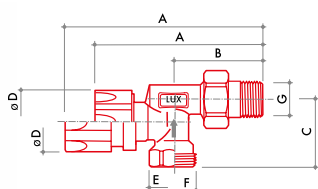

M 322

Valvola radiatore a corpo reverso termostattabile o elettrocomandabile con cappuccio di protezione. Attacchi tubo ferro.

Raccordi



CODICE	MISURA	A	B	C	D	E	F	G	H	L			
13202100	DN 15 1/2	95	52	40	37	G 1/2	-	R 1/2	-	-	221	10	80

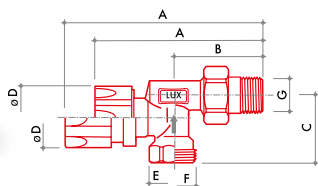

M 332

Valvola radiatore a corpo reverso termostattabile o elettrocomandabile con volantino di comando manuale. Attacchi tubo ferro.

Raccordi



CODICE	MISURA	A	B	C	D	E	F	G	H	L			
13222100	DN 15 1/2	116	52	40	35	G 1/2	-	R 1/2	-	-	228	10	80



Raccordi per tubo rame



Raccordi per tubo plastica



Raccordi per tubo multistrato



Raccordi: capitolo 7



Accessori: capitolo 1.A

DIAGRAMMA DI PORTATA VALVOLE

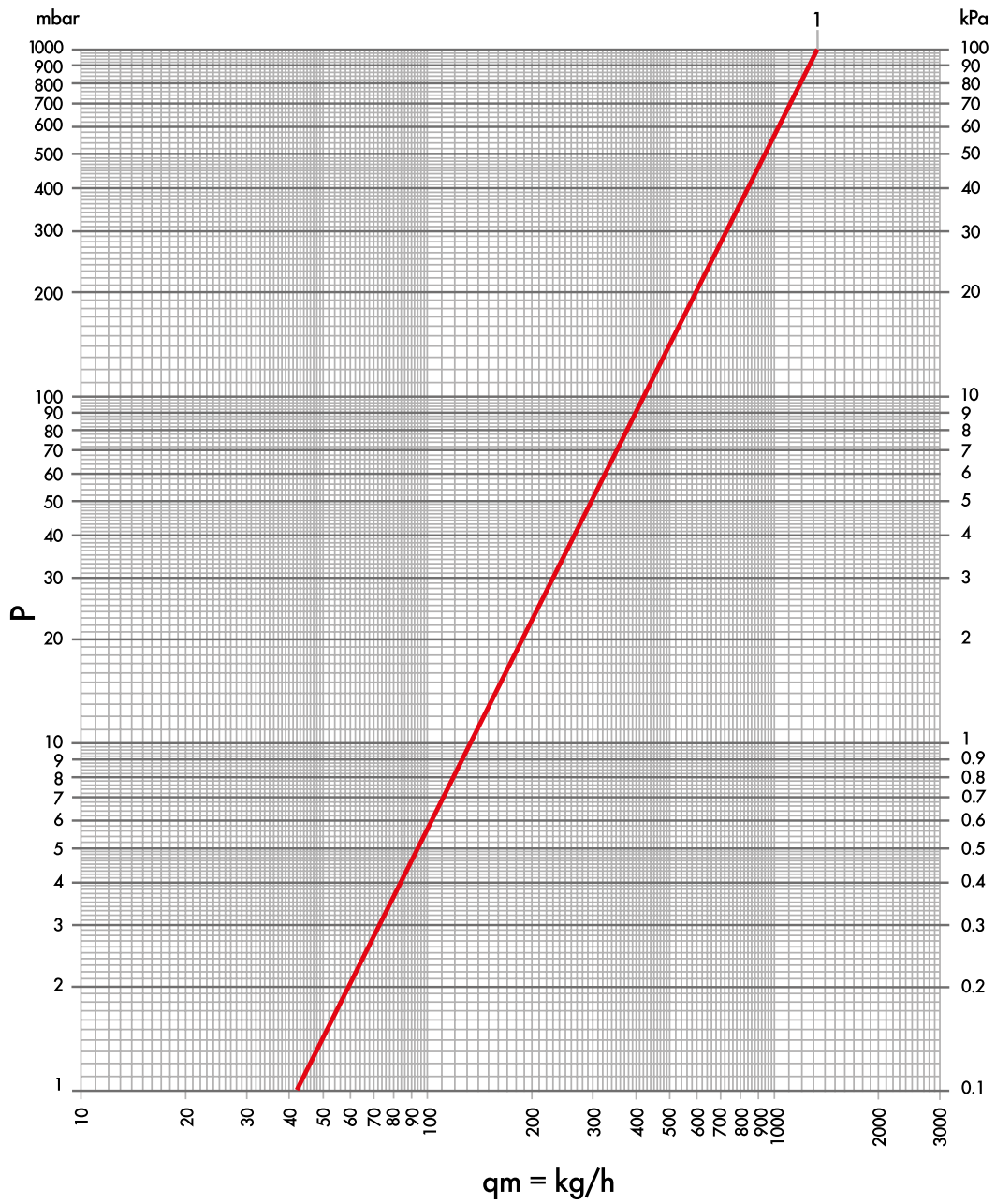

ARTICOLI	Kv	POS
M 300	1.31	1

DIAGRAMMA DI PORTATA VALVOLE

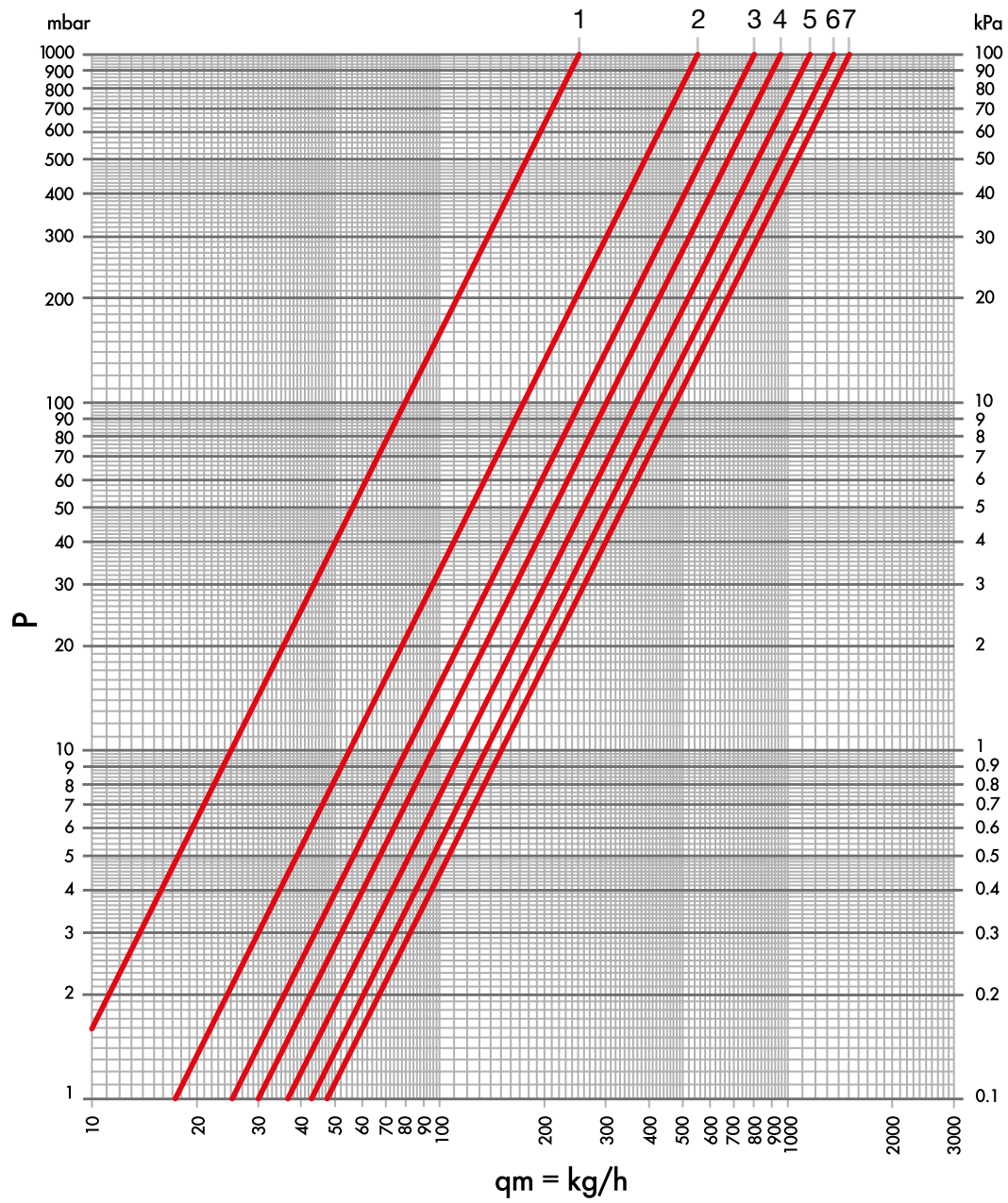

ARTICOLI	N. GIRI	Kv	POS
MD 331/A MS 331/A	1	0,25	1
	1+1/2	0,55	2
	2	0,80	3
	2+1/2	0,95	4
	3	1,15	5
	3+1/2	1,35	6
	tutto aperto	1,50	7

DIAGRAMMA DI PORTATA VALVOLE

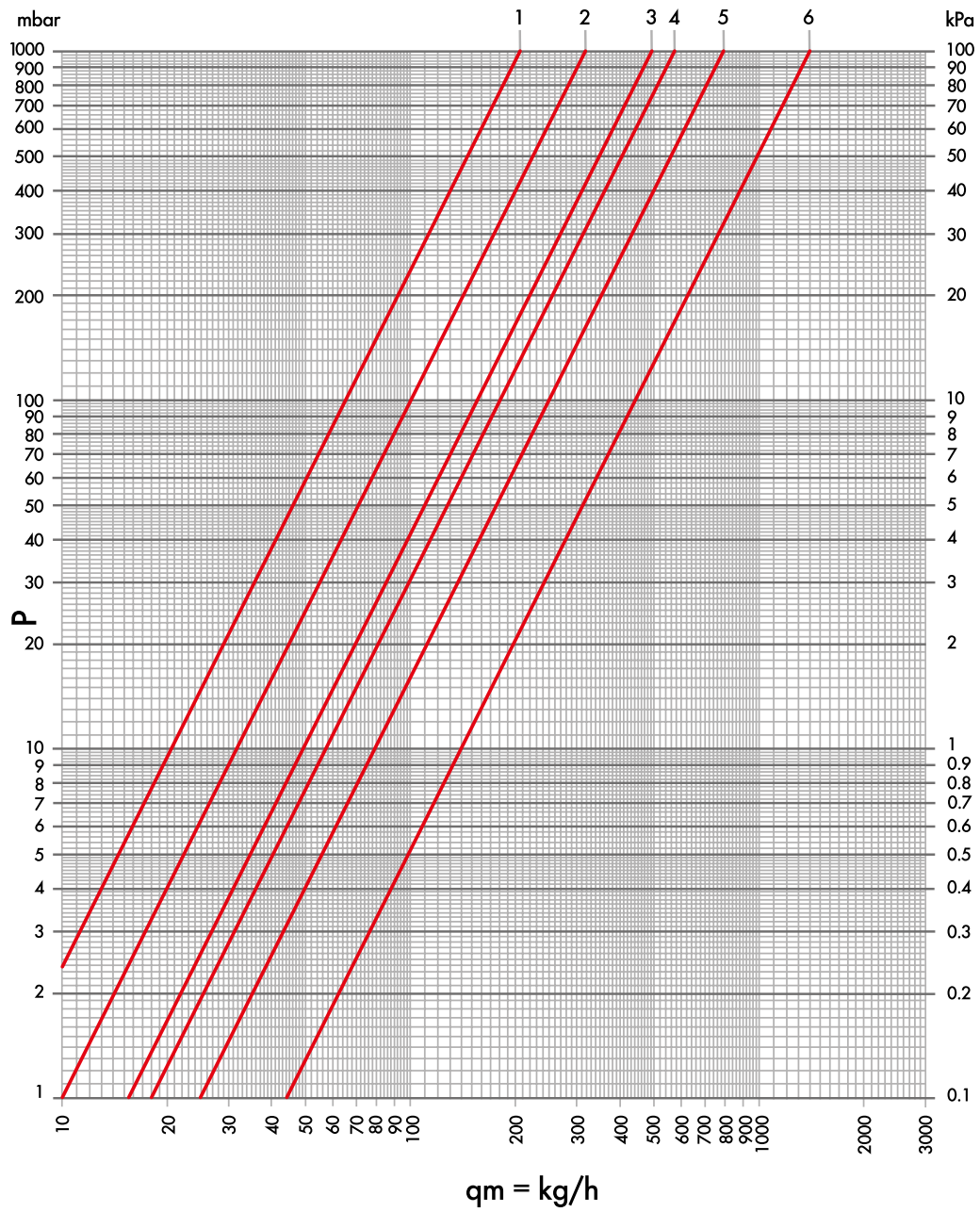

ARTICOLI	Kv	Kv Δt 1 °C	Kv Δt 2 °C	POS
	0.21	0.15	0.19	1
M 320 M 320/A	0.32	0.20	0.25	2
M 330 M 330/A	0.49	0.24	0.36	3
M 322 M 332	0.57	0.24	0.37	4
MD 321/A MS 331/A	0.79	0.24	0.40	5
	1.39	0.32	0.55	6

M

DISTRIBUTORI A 4 VIE PER IMPIANTI MONOTUBO E BITUBO

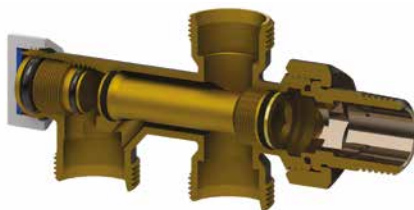

I distributori hanno la tenuta verso l'esterno assicurata da un o-ring e da una guarnizione piatta all'interno del tappo. La tenuta in chiusura con l'otturatore è assicurata da un o-ring.

I distributori sono prodotti con finitura nichelata. Tutti i distributori hanno la possibilità di regolare la portata limitando l'alzata dell'otturatore.

CARATTERISTICHE TECNICHE



DN

15



Max temperatura

120 °C



Max pressione

10 bar



Max pressione differenziale

1 bar



Materiale

CW617N
UNI EN
12165:2016



Manopola

ABS bianco
RAL 9016

ATTACCHI IMPIANTO

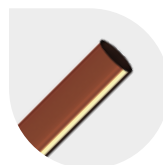
**Tubo rame**

W 24x19 - TR 91

**Tubo plastica**

W 24x19 - TP 95

**Tubo multistrato**

W 24x19 - TP 97

COLLEGAMENTO RADIATORE



**filetto
conico
zigrinato**
G 1/2

INTERASSI

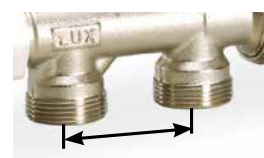

40 mm

INSTALLAZIONE CON VALVOLE A CORPO REVERSO

I distributori serie M devono essere installati rispettando scrupolosamente la freccia stampata sul corpo indicante la direzione del flusso.

I distributori a 4 vie possono avere l'attacco all'impianto dal pavimento o dalla parete.

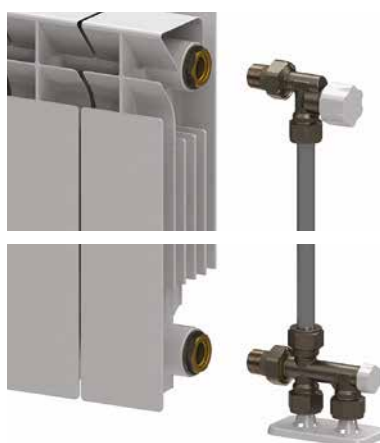

Le caratteristiche del fluido dell'impianto devono essere conformi alla direttiva UNI 8065:2019.

**DISTRIBUTORI A 4 VIE PER IMPIANTI MONOTUBO E BITUBO:
ATTACCO TUBO RAME E TUBO PLASTICA W24X19**

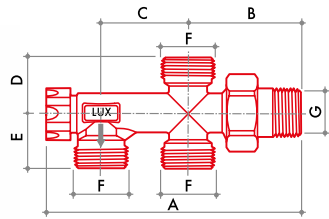

M 341

Distributore a 4 vie con attacchi a pavimento. Portata massima al corpo scaldante: 50% della portata dell'anello. Attacchi tubo rame e tubo plastica.

Raccordi



CODICE	MISURA	A	B	C	D	E	F	G	H	L			
13142100	DN 15 1/2	118	52	40	25	25	W24x19	R 1/2	-	-	243	10	80

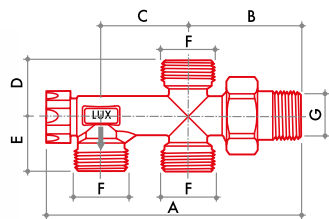

M 351

Distributore a 4 vie con attacchi a pavimento. Portata massima al corpo scaldante: 100% della portata dell'anello. Attacchi tubo rame e tubo plastica.

Raccordi



CODICE	MISURA	A	B	C	D	E	F	G	H	L			
13152100	DN 15 1/2	118	52	40	25	25	W24x19	R 1/2	-	-	244	10	80

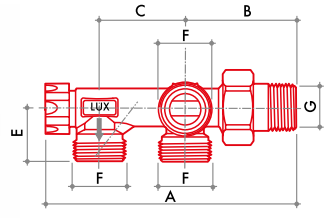

M 361

Distributore a 4 vie con attacchi a parete. Portata massima al corpo scaldante: 50% della portata dell'anello. Attacchi tubo rame e tubo plastica.

Raccordi



CODICE	MISURA	A	B	C	D	E	F	G	H	L			
13242100	DN 15 1/2	118	52	40	-	25	W24x19	R 1/2	-	-	308	6	48

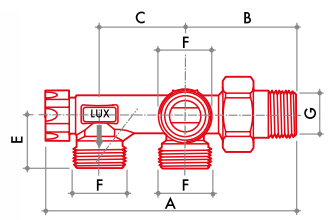

M 371

Distributore a 4 vie con attacchi a parete. Portata massima al corpo scaldante: 100% della portata dell'anello. Attacchi tubo rame e tubo plastica.

Raccordi

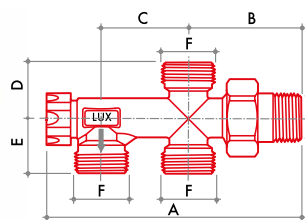

CODICE	MISURA	A	B	C	D	E	F	G	H	L			
13252100	DN 15 1/2	118	52	40	-	25	W24x19	R 1/2	-	-	309	6	48

**DISTRIBUTORI A 4 VIE PER IMPIANTI MONOTUBO E BITUBO:
ATTACCO TUBO RAME E TUBO PLASTICA G3/4 EUROCONO**
**M 341/A**

Distributore a 4 vie con attacchi a pavimento. Portata massima al corpo scaldante: 50% della portata dell'anello. Attacchi tipo eurocono.

Raccordi

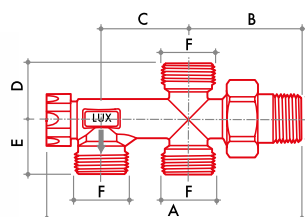

CODICE	MISURA	A	B	C	D	E	F	G	H	L			
13142721	DN 15 1/2	118	52	40	25	25	G 3/4 EK	R 1/2	-	-	245	10	80

**M 351/A**

Distributore a 4 vie con attacchi a pavimento. Portata massima al corpo scaldante: 100% della portata dell'anello. Attacchi tipo eurocono.

Raccordi

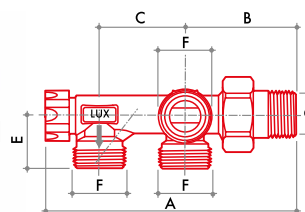

CODICE	MISURA	A	B	C	D	E	F	G	H	L			
13152721	DN 15 1/2	118	52	40	25	25	G 3/4 EK	R 1/2	-	-	256	10	80

**M 361/A**

Distributore a 4 vie con attacchi a parete. Portata massima al corpo scaldante: 50% della portata dell'anello. Attacchi tipo eurocono.

Raccordi

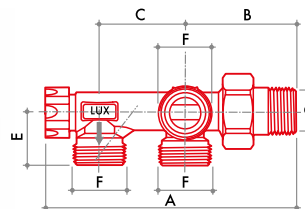

CODICE	MISURA	A	B	C	D	E	F	G	H	L			
13242721	DN 15 1/2	118	52	40	-	25	G 3/4 EK	R 1/2	-	-	310	6	48

**M 371/A**

Distributore a 4 vie con attacchi a parete. Portata massima al corpo scaldante: 100% della portata dell'anello. Attacchi tipo eurocono.

Raccordi



CODICE	MISURA	A	B	C	D	E	F	G	H	L			
13252721	DN 15 1/2	118	52	40	-	25	G 3/4 EK	R 1/2	-	-	320	6	48



Raccordi per tubo rame



Raccordi per tubo plastica



Raccordi per tubo multistrato



Raccordi: capitolo 7



Accessori: capitolo 1.A

DIAGRAMMA DI PORTATA DISTRIBUTORI

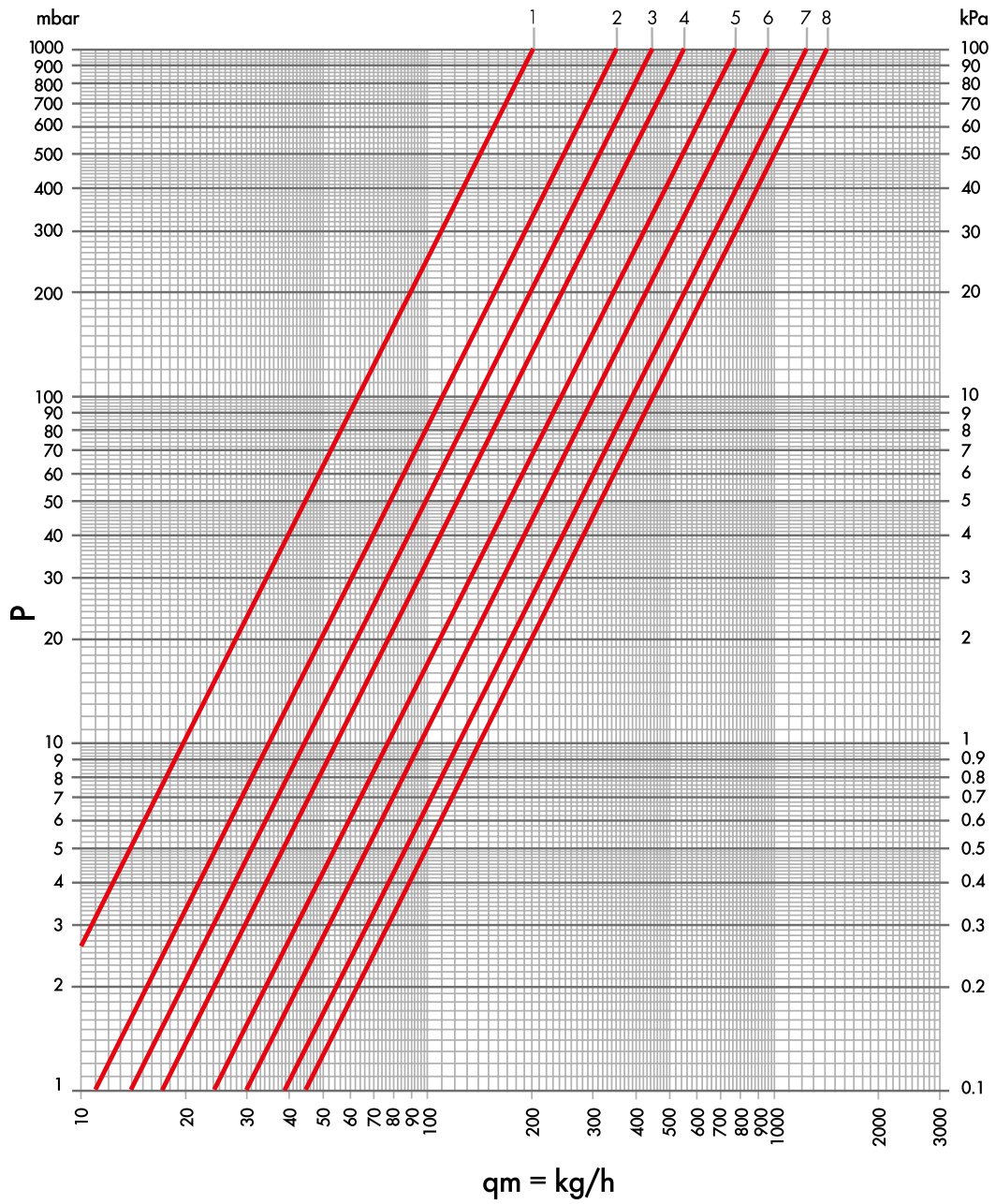

ARTICOLI	N. GIRI	Kv	POS
M 351 M 351/A M 371 M 371/A	1	0.20	1
	1+1/2	0.35	2
	2	0.43	3
	2+1/2	0.55	4
	3	0.78	5
	3+1/2	0.95	6
	4	1.22	7
	tutto aperto	1.41	8

DIAGRAMMA DI PORTATA DISTRIBUTORI

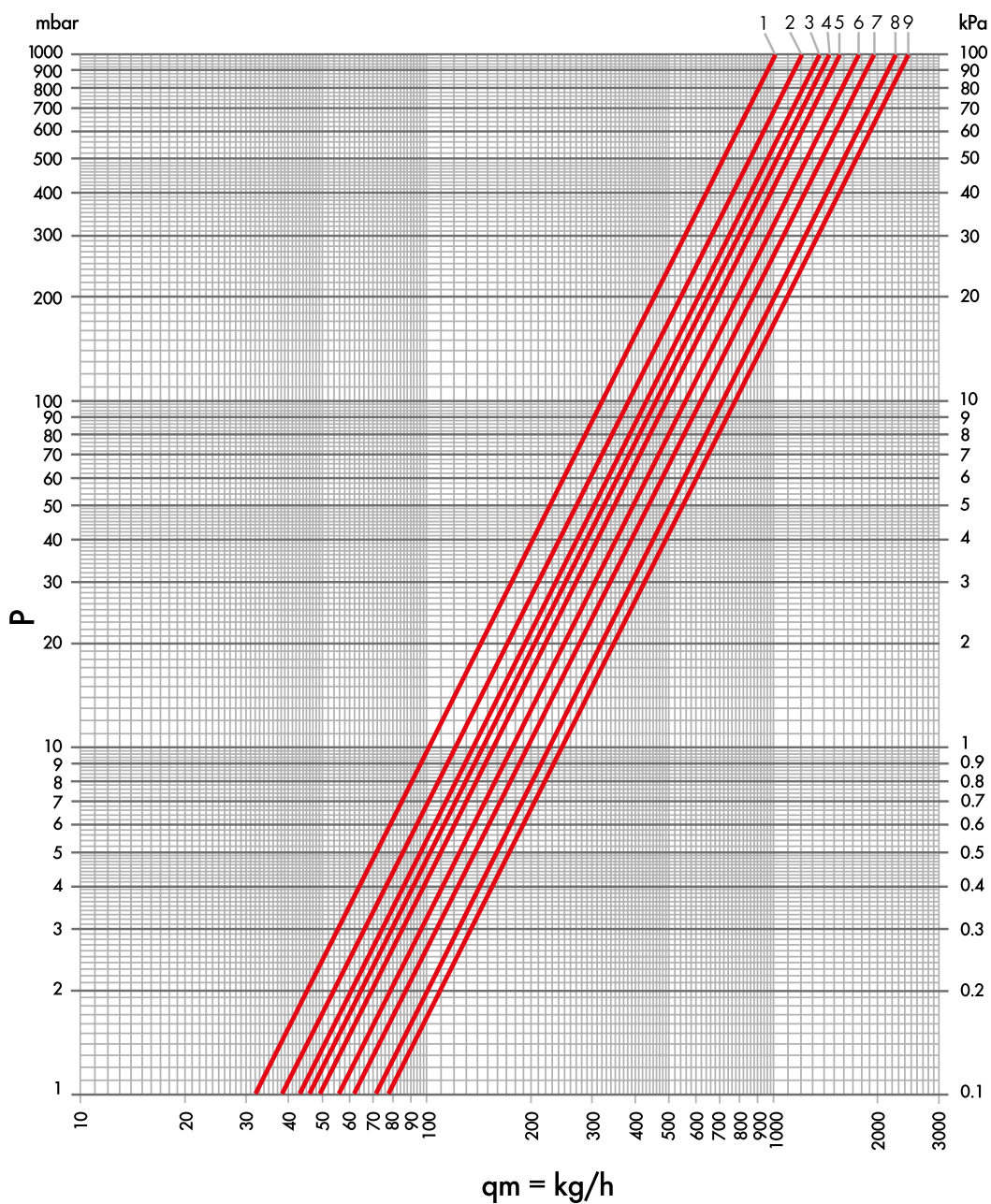

ARTICOLI	N. GIRI	Kv	POS
M 341 M 341/A M 361 M 361/A	chiuso	1.00	1
	1	1.20	2
	1+1/2	1.35	3
	2	1.43	4
	2+1/2	1.55	5
	3	1.78	6
	3+1/2	1.95	7
	4	2.22	8
	tutto aperto	2.41	9

M VALVOLE COASSIALI



Le valvole coassiali hanno un vitone che offre la possibilità di prerogolazione grazie ad un anello in acetalica sagomato. Il vitone termostatico permette la sostituzione di uno degli o-ring di tenuta sull'asta di comando senza che sia necessario svuotare l'impianto. Le valvole sono prodotte con finitura nichelata.

I detentori hanno la tenuta assicurata da un o-ring sull'otturatore e se necessario da un ulteriore o-ring tra il corpo e il tappo. La tenuta in chiusura con l'otturatore è assicurata da un o-ring e da una tenuta conica metallica. I detentori sono prodotti con finitura nichelata. Tutti i detentori hanno la possibilità di regolare la portata limitando l'alzata dell'otturatore.

CARATTERISTICHE TECNICHE



DN

15



Max temperatura

120 °C



Max pressione

10 bar



Max pressione differenziale (valvole termostatiche)

0,6 bar



Max pressione differenziale

1 bar



Materiale

CW617N
UNI EN
12165:2016



Manopola

ABS bianco
RAL 9016



Asta di comando

AISI 316

ATTACCHI IMPIANTO

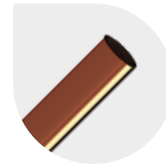

Tubo rame
G 3/4 EK - TR 91/A

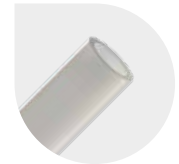

Tubo plastica
G 3/4 EK - TP 98



Tubo multistrato
G 3/4 EK - TP 99

COLLEGAMENTO RADIATORE



**filetto
conico zigrinato**
G 1/2

COME SELEZIONARE LE VALVOLE COASSIALI CORRETTE

KIT TERMOSTATICO COASSIALE DESTRA



Detentore sinistro

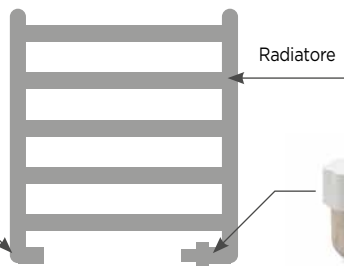

Radiatore



Valvola termostatica
o manuale destra

KIT TERMOSTATICO COASSIALE SINISTRA



Valvola termostatica
o manuale sinistra

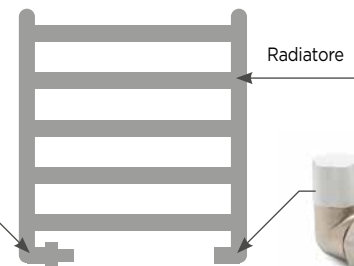

Radiatore



Detentore destro

Le caratteristiche del fluido dell'impianto devono essere conformi alla direttiva UNI 8065:2019.

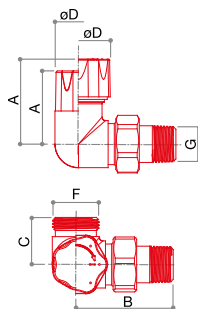

VALVOLE COASSIALI: ATTACCO TUBO RAME E TUBO PLASTICA G3/4 EUROCONO

**MD 321/A**

Valvola radiatore coassiale destra termostattabile o elettrocomandabile con cappuccio di protezione. Attacco tipo eurocono.

Raccordi



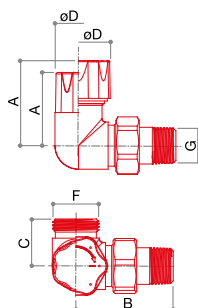

CODICE	MISURA	A	B	C	D	E	F	G	H	L			
13272722	DN 15 1/2	49	56	27	37	-	G 3/4 EK	R 1/2	-	-	287	10	80

**MS 331/A**

Detentore di regolazione coassiale sinistro. Attacchi tipo eurocono.

Raccordi



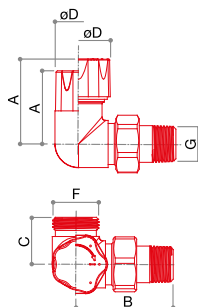

CODICE	MISURA	A	B	C	D	E	F	G	H	L			
13252722	DN 15 1/2	42	56	27	30	-	G 3/4 EK	R 1/2	-	-	258	10	80

**MS 321/A**

Valvola radiatore coassiale sinistra termostattabile o elettrocomandabile con cappuccio di protezione. Attacco tipo eurocono.

Raccordi



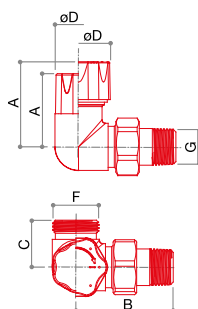

CODICE	MISURA	A	B	C	D	E	F	G	H	L			
13292722	DN 15 1/2	49	56	27	37	-	G 3/4 EK	R 1/2	-	-	287	10	80

**MD 331/A**

Detentore di regolazione coassiale destro. Attacco tipo eurocono.

Raccordi



CODICE	MISURA	A	B	C	D	E	F	G	H	L			
13232722	DN 15 1/2	42	56	27	30	-	G 3/4 EK	R 1/2	-	-	258	10	80



Raccordi per tubo rame



Raccordi per tubo plastica



Raccordi per tubo multistrato



Raccordi: capitolo 7



Accessori: capitolo 1.A

M

DISTRIBUTORI PER IMPIANTI MONOTUBO E BITUBO PER CORPI SCALDANTI CON VALVOLA INCORPORATA



I distributori hanno la tenuta assicurata da un o-ring e da una guarnizione piatta all'interno del tappo. La tenuta in chiusura con l'otturatore è assicurata da un o-ring e da una tenuta conica metallica.

I distributori sono prodotti con finitura nichelata. Tutti i distributori hanno la possibilità di regolare la portata limitando l'alzata dell'otturatore.

CARATTERISTICHE TECNICHE



DN

15



Max temperatura

120 °C



Max pressione

10 bar



Max pressione differenziale

1 bar



Materiale

CW617N
UNI EN
12165:2016



Manopola

ABS bianco
RAL 9016

ATTACCHI IMPIANTO

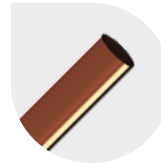

Tubo rame

W 24x19 - TR 91
G 3/4 EK - TR 91/A

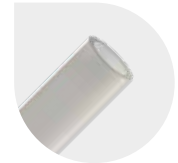

Tubo plastica

W 24x19 - TP 95
G 3/4 EK - TP 98



Tubo multistrato

W 24x19 - TP 97
G 3/4 EK - TP 99

INTERASSI

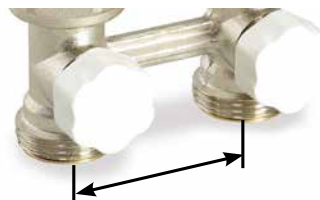

50 mm

COLLEGAMENTO RADIATORE

I distributori sono progettati per poter essere collegati ai corpi scaldanti con attacchi da G 3/4 eurocono.

Nel caso gli attacchi siano da G 1/2 F è possibile utilizzare gli adattatori art. M 532.

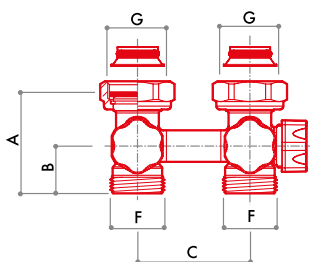

Le caratteristiche del fluido dell'impianto devono essere conformi alla direttiva UNI 8065:2019.

DISTRIBUTORI PER IMPIANTI MONOTUBO E BITUBO PER CORPI SCALDANTI CON VALVOLA INCORPORATA: ATTACCO TUBO RAME E TUBO PLASTICA W24x19
**M 171**

Distributori mono-bitubo

- attacchi al corpo scaldante con dado girevole da 3/4 femmina
- attacchi pavimento 24x19 per tubo rame o plastica.

Raccordi

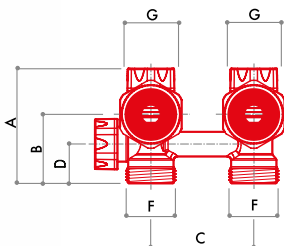

CODICE	MISURA	A	B	C	D	E	F	G	H	L			
13462100	-	45	21	50	-	-	W24x19	G 3/4	-	-	315	6	48

**M 173**

Distributori mono-bitubo

- attacchi al corpo scaldante con dado girevole da 3/4 femmina
- attacchi a parete 24x19 per tubo rame o plastica.

Raccordi

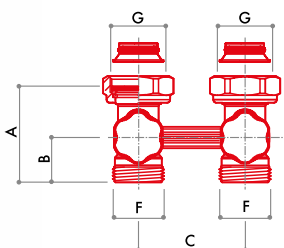

CODICE	MISURA	A	B	C	D	E	F	G	H	L			
13462101	-	57	34	50	19	-	W24x19	G 3/4	-	-	310	6	48

**M 175**

Distributori bitubo

- attacchi al corpo scaldante con dado girevole da 3/4 femmina
- attacchi pavimento 24x19 per tubo rame o plastica.

Raccordi

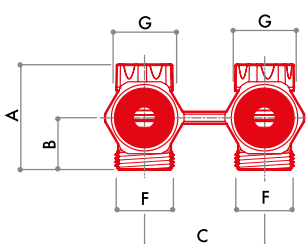

CODICE	MISURA	A	B	C	D	E	F	G	H	L			
13472100	-	45	21	50	-	-	W24x19	G 3/4	-	-	245	6	48

**M 177**

Distributori bitubo

- attacchi al corpo scaldante con dado girevole da 3/4 femmina
- attacchi a parete 24x19 per tubo rame o plastica.

Raccordi



CODICE	MISURA	A	B	C	D	E	F	G	H	L			
13472101	-	44	22	50	-	-	W24x19	G 3/4	-	-	255	6	48



Raccordi per tubo rame



Raccordi per tubo plastica



Raccordi per tubo multistrato



Raccordi: capitolo 7



Accessori: capitolo 1.A

DISTRIBUTORI PER IMPIANTI MONOTUBO E BITUBO PER CORPI SCALDANTI CON VALVOLA INCORPORATA: ATTACCO TUBO RAME E TUBO PLASTICA G3/4 EUROCONO

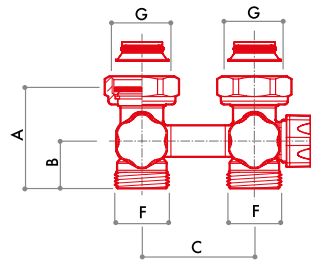

M 172

Distributori mono-bitubo

- attacchi al corpo scaldante con dado girevole da 3/4 femmina
- attacchi pavimento tipo eurocono per tubo rame o plastica.

Raccordi



CODICE	MISURA	A	B	C	D	E	F	G	H	L			
13462700	-	45	21	50	-	-	G 3/4 EK	G 3/4	-	-	325	6	48

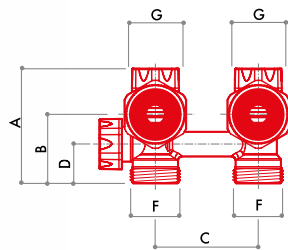

M 174

Distributori mono-bitubo

- attacchi al corpo scaldante con dado girevole da 3/4 femmina
- attacchi a parete tipo eurocono per tubo rame o plastica.

Raccordi



CODICE	MISURA	A	B	C	D	E	F	G	H	L			
13462701	-	57	34	50	19	-	G 3/4 EK	G 3/4	-	-	320	6	48

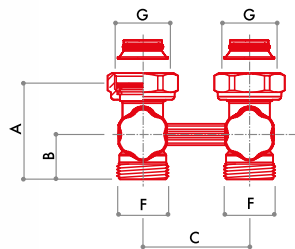

M 176

Distributori bitubo

- attacchi al corpo scaldante con dado girevole da 3/4 femmina
- attacchi pavimento tipo eurocono per tubo rame o plastica.

Raccordi



CODICE	MISURA	A	B	C	D	E	F	G	H	L			
13472700	-	45	21	50	-	-	G 3/4 EK	G 3/4	-	-	255	6	48

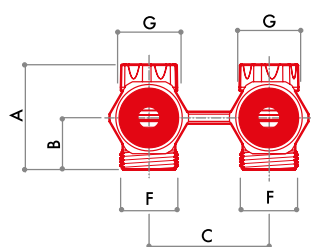

M 178

Distributori bitubo

- attacchi al corpo scaldante con dado girevole da 3/4 femmina
- attacchi a parete tipo eurocono per tubo rame o plastica.

Raccordi



CODICE	MISURA	A	B	C	D	E	F	G	H	L			
13472701	-	44	22	50	-	-	G 3/4 EK	G 3/4	-	-	260	6	48

DIAGRAMMA DI PORTATA DISTRIBUTORI

DIAGRAMMA DI REGOLAZIONI BYPASS

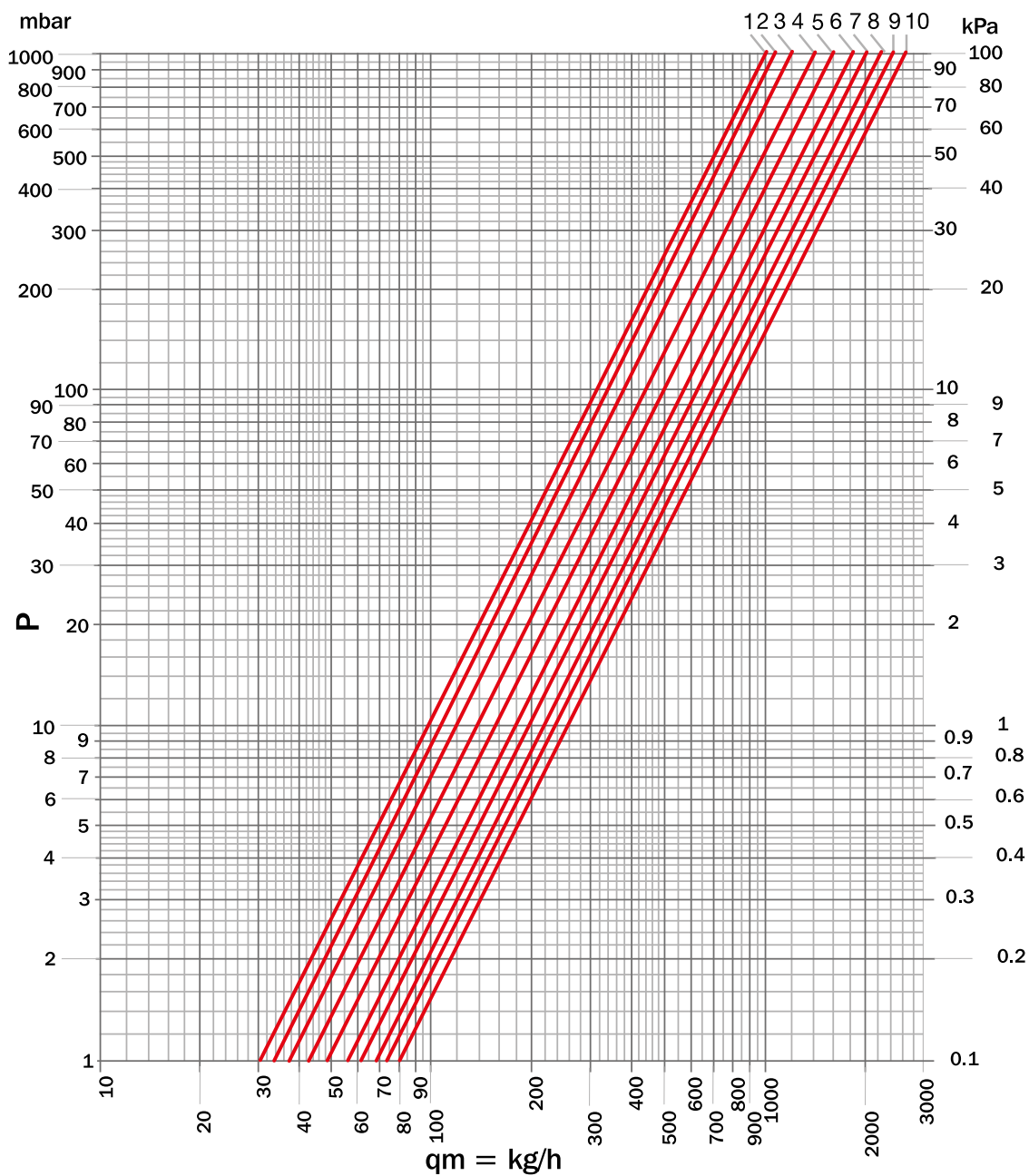

ARTICOLI	N. GIRI	Kv bypass	Kvs	POS
M 171 M 172 M 173 M 174	0	0	1,00	1
	1/4	0,13	1,13	2
	1/2	0,22	1,22	3
	3/4	0,43	1,43	4
	1	0,65	1,65	5
	1+1/4	0,80	1,80	6
	1+1/2	0,97	1,97	7
	2	1,20	2,20	8
	2+1/2	1,38	2,38	9
	3	1,60	2,60	10

DIAGRAMMA DI PORTATA DISTRIBUTORI

DIAGRAMMA DI REGOLAZIONI

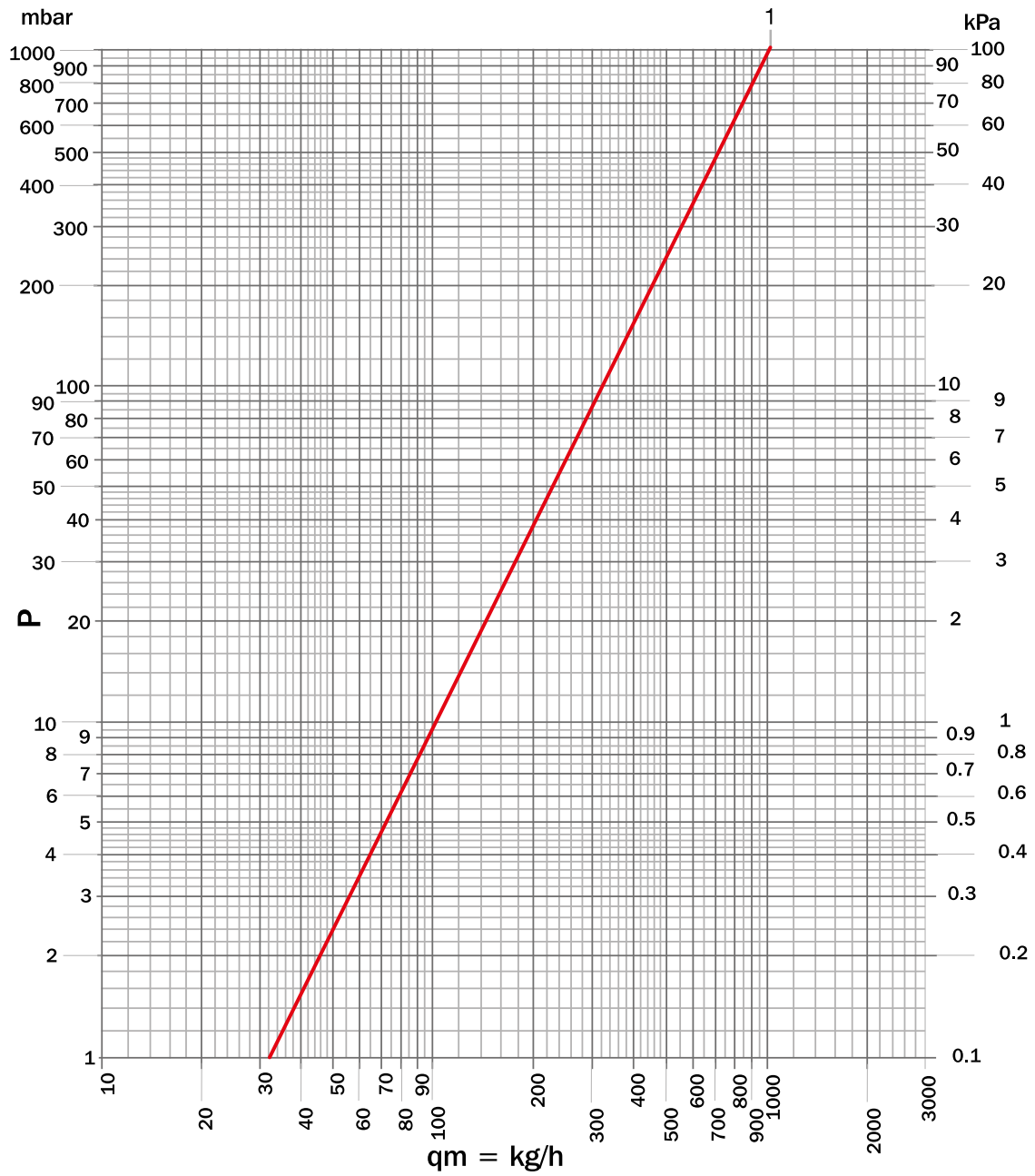

ARTICOLI	RA %	N. GIRI	Kvs	POS
M 175 M 176 M 177 M 178	100%	tutto aperto	1	1





VALVOLE RADIATORE

1.A / ACCESSORI

ACCESSORI PER VALVOLE, DETENTORI, VALVOLE A 4 VIE E DISTRIBUTORI LUXOR



**507**

Dado in ottone per raccordo a sede sferica per valvole, detentori e valvole serie M (1/2 per raccordi a 90° valvole diritte serie M).

CODICE	MISURA			
1946672	G 5/8 - DN 10 3/8	28	-	-
1946676LN	G 3/4 - DN 15 1/2	25	-	-
1946682	G 1" - DN 20 3/4	45	-	-

**517**

Rosetta universale apribile con chiusura a scatto in PP polipropilene di colore bianco (copri foro murale).

CODICE	MISURA			
67790220	8÷22 mm	6	25	500



**508**

Raccordo a sede sferica in ottone con tenuta o-ring e filetto gas conico per valvole e detentori.

CODICE	MISURA			
67891700	DN 10 3/8	24	50	400
67892100	DN 15 1/2	37	50	400
67892700	DN 20 3/4	64	30	240

**518**

Rosetta apribile con chiusura a scatto in PP polipropilene di colore bianco (copri foro murale).

CODICE	MISURA			
67790217	G 3/8-18 mm	6	25	500
67790221	G 1/2	6	25	500
67790227	G 3/4	6	25	500
67790210	10 mm	6	25	500
67790212	12 mm	6	25	500
67790214	14 mm	6	25	500
67790216	16 mm	6	25	500



**508/B**

Raccordo speciale a sede sferica in ottone con doppia tenuta o-ring per valvole e detentori.

CODICE	MISURA			
67001700	DN 3/8	39	40	320

**M 529**

Rosetta apribile ad incastro in ABS di colore bianco (copri foro murale).

CODICE	MISURA			
67790265	Ø15÷16 mm	8	200	1200



**509**

Guarnizioni di tenuta o-ring in EPDM per raccordi a sede sferica.

CODICE	MISURA			
3424650	DN 10 3/8	-	-	-
3424662	DN 15 1/2	-	-	-
3424693	DN 20 3/4	-	-	-

**M 530**

Rosetta apribile doppia ad incastro in ABS di colore bianco RAL 9016 (copri foro murale).

CODICE	MISURA	INTERASSE			
67790238	Ø15÷16 mm	38 mm	17	50	300
67790250	Ø15÷16 mm	50 mm	17	50	300



**CR 498**

Dado e raccordo, nichelati, con tenuta o-ring per il collegamento delle valvole di regolazione e detentori.

CODICE	MISURA			
67901700	DN 10 3/8	60	50	400
67902100	DN 15 1/2	72	50	400
67902700	DN 20 3/4	120	20	160

**M 531**

Rosetta universale apribile doppia ad incastro in ABS di colore bianco RAL 9016.

CODICE	MISURA	INTERASSE			
67790240	Ø10÷16 mm	40 mm	12	100	600

ACCESSORI PER SERIE EASY E SMART

**574**

Volantino in ABS di colore bianco RAL 9016 per valvole serie Easy.

CODICE	MISURA			
4761915	-	12	-	-

**505**

Guarnizione piana in fasit 205 per tappo art. 578.

CODICE	MISURA			
3405850	-	1	-	-

**578**

Tappo in ABS di colore bianco RAL 9016 per detentori serie Easy.

CODICE	MISURA			
8761935	W19x19	2	-	-

ACCESSORI PER SERIE TEKNA

**570**

Volantino in ABS di colore bianco RAL 9016 per valvole serie Tekna.

CODICE	MISURA			
4761903	-	10	-	-

**572**

Tappo per volantino in ABS di colore bianco RAL 9016 per valvole serie Tekna.

CODICE	MISURA			
8761903	-	2	-	-

**580**

Vite ferma volantino in ottone per valvole serie Tekna.

CODICE	MISURA			
9346615	-	1	-	-

**576**

Tappo in ABS di colore bianco RAL 9016 per detentori serie Tekna.

CODICE	MISURA			
8761923	M23x19	6	-	-

ACCESSORI PER SERIE THERMOTEKNA

**VT 2600**

Volantino di comando manuale per valvole ThermoTekna. Manopola e ghiera di fissaggio in ABS di colore bianco RAL 9016.

CODICE	MISURA			
69010104	M30x1.5	16	30	240

**TM 245**

Cappuccio di protezione per valvole ThermoTekna in ABS di colore bianco RAL 9016.

CODICE	MISURA			
8761904	M30x1.5	8	50	400

**515**

Vitone termostatico con pre-regolazione per valvole serie ThermoTekna.

CODICE	MISURA			
67980006	-	24	-	-

**CH 112**

Chiave per la regolazione della portata delle valvole termostaticizzabile ThermoTekna con l'impianto in funzione.

CODICE	MISURA			
67822717	-	10	100	-

**CH 111**

Chiave per la sostituzione del vitone termostatico delle valvole serie ThermoTekna con impianto in funzione.

CODICE	MISURA			
67822720	-	2097	1	-

**583**

Guarnizioni di tenuta o-ring in EPDM per vitone termostatico serie ThermoTekna.

CODICE	MISURA			
3424704	-	-	-	-

ACCESSORI PER SERIE 50th

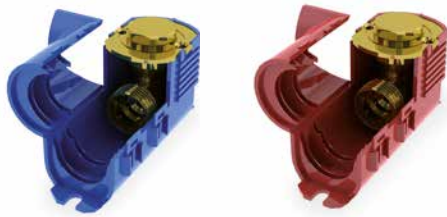

CS 1995

Raccordo curvo sottotraccia a 90° singolo di colore blu o rosso, senza staffa e con tappo in ottone con o-ring per prova di tenuta.

CODICE	MISURA						
66004100B	G 1/2 x (W24x19)	TR 91	TP 95	TP 97	122	8	64
66004100R	G 1/2 x (W24x19)	TR 91	TP 95	TP 97	122	8	64
66004102B	G 1/2 x G 3/4 EK	TR 91/A	TP 98	TP 99	127	8	64
66004102R	G 1/2 x G 3/4 EK	TR 91/A	TP 98	TP 99	127	8	64



M 528

Tubo di raccordo in rame cromato a tenuta morbida per scatola di distribuzione sottotraccia.

CODICE	MISURA			
67510015	G 1/2 x (Ø 15 x 140)	72	35	280
67520015	G 1/2 x (Ø 15 x 175)	86	30	240



535

Rosetta universale apribile ad incastro in ABS cromato (copri foro murale).

CODICE	MISURA			
67790224C	10 ÷ 22 mm	6	100	-



536

Rosetta universale copri tubo totale apribile ad incastro in ABS cromato (copri foro murale).

CODICE	MISURA			
67790225C	10 ÷ 18 mm	18	25	-

ACCESSORI PER SERIE M-MT

**M 525**

Prolunga in PA 6 poliammide per sonde valvole monotubo a 4 vie.

CODICE	MISURA			
67790230	400 mm	16	50	500
67790299	1000 mm	40	-	-

**513**

Guarnizione cilindrica in PTFE per asta di comando valvole serie M 87 e M 88.

CODICE	MISURA			
3489805	-	1	-	-

**584**

Raccordo al radiatore in ottone per valvole monotubo a 4 vie M 85 e M 86.

CODICE	MISURA			
0746810M	-	155	25	200

**M 520**

Dado in ottone per raccordo al radiatore valvole monotubo a 4 vie.

CODICE	MISURA			
1946803	-	52	-	-

**586**

Sonda con deviatore di flusso in PA 6 per valvola monotubo M 85 e M 86.

CODICE	MISURA			
7761810	-	4	-	-

**M 521**

Raccordo al radiatore in ottone per valvole monotubo a 4 vie.

CODICE	MISURA			
7146803	DN 15 1/2	41	-	-
7146805	DN 20 3/4	38	-	-

**500**

Volantino in ABS di colore bianco RAL 9016 per valvole serie M 87 e M 88.

CODICE	MISURA			
4761603	-	11	-	-

**M 522**

Controsonda con deviatore di flusso in PA 6 poliammide per valvole monotubo a 4 vie serie M.

CODICE	MISURA			
7761811	-	3	-	-

**512**

Dado in ottone premiguarnizione cilindrica in PTFE per asta comando valvole serie M 87 e M 88.

CODICE	MISURA			
1946602	-	7	-	-

**M 523**

Sonda con deviatore di flusso in PA 6 poliammide per valvole monotubo a 4 vie.

CODICE	MISURA			
7761803	DN 15 1/2	7	-	-
7761805	DN 20 3/4	7	-	-

**M 524**

Guarnizione piana in fasit omnia per raccordo al radiatore valvole monotubo a 4 vie.

CODICE	MISURA			
3405855	-	2	-	-



M 526

Tubo in acciaio morbido cromato per collegamento dei gruppi monotubo a due attacchi (valvole a corpo reverso e valvole diritte con raccordo a 90° collegate con i distributori M 340, M 340/A, M 350, M 350/A, M 360, M 360/A, M 370 e M 370/A).

CODICE	MISURA	LUNGHEZZA			
67500115	Ø 15 mm	500 mm	172	-	-
67500215	Ø 15 mm	600 mm	208	-	-
67500315	Ø 15 mm	800 mm	278	-	-
67500015	Ø 15 mm	1000 mm	348	-	-



M 532

Riduzione in ottone con o-ring di tenuta per distributori mono-bitubo.

CODICE	MISURA			
69190000	3/4 M x 1/2 M	30	100	800



M 533

Adattatori eurocono in ottone con o-ring di tenuta per distributori mono-bitubo.

CODICE	MISURA			
69190200	-	10	100	800



COLLETTORI SEMPLICI

2.1 / SERIE CP

CP

COLLETTORI SEMPLICI COMPONENTI



*Conforme secondo
il D.M. 174/2004

La lavorazione eseguita dopo il trattamento di nichelatura rende i collettori CP conformi al D.M. 174/2004 per il trasporto di acqua potabile.

Tutti i collettori subiscono un trattamento di distensione del metallo al fine di eliminare eventuali tensioni causate dalla lavorazione.

CARATTERISTICHE TECNICHE



Max temperatura

120 °C



Max pressione

10 bar



Materiale

CW617N
UNI EN
12165:2016

ATTACCHI IMPIANTO



Tubo ferro
G 1/2



Tubo rame
W 24x19 - TR 91
G 3/4 EK - TR 91/A
G 1/2 - TR 890



Tubo plastica
W 24x19 - TP 95
G 3/4 EK - TP 98
G 1/2 - TP 93



Tubo multistrato
W 24x19 - TP 97
G 3/4 EK - TP 99
G 1/2 - TP 96

**ATTACCO
CORPO
PRINCIPALE**

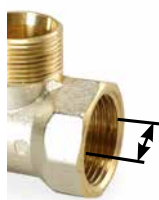

G 3/4
G 1"

INTERASSI



40 mm

Le caratteristiche del fluido dell'impianto devono essere conformi alla direttiva UNI 8065:2019.

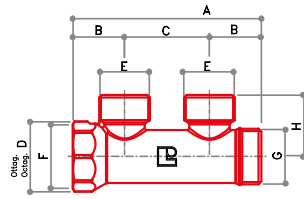
**COLLETTORI SEMPLICI COMPONENTI:
ATTACCO TUBO RAME E TUBO PLASTICA W24X19**
**CP 402**

Collettori con due attacchi laterali maschio da (W24x19). Conforme secondo il D.M. 174/2004.



Raccordi

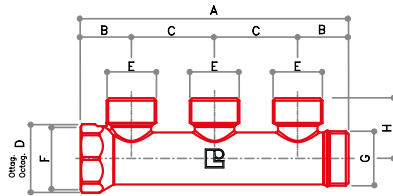

CODICE	MISURA	A	B	C	D	E	F	G	H	L			
68522700	G 3/4 x (W24x19)	89	24,5	40	31	W24x19	G 3/4	G 3/4	29	-	180	15	120
68523400	G 1" x (W24x19)	89	24,5	40	38	W24x19	G 1"	G 1"	32,5	-	210	12	96

**CP 403**

Collettori con tre attacchi laterali maschio da (W24x19). Conforme secondo il D.M. 174/2004.



Raccordi

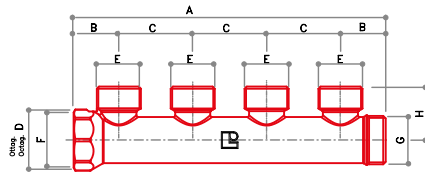

CODICE	MISURA	A	B	C	D	E	F	G	H	L			
68532700	G 3/4 x (W24x19)	129	24,5	40	31	W24x19	G 3/4	G 3/4	29	-	240	12	96
68533400	G 1" x (W24x19)	129	24,5	40	38	W24x19	G 1"	G 1"	32,5	-	290	8	64

**CP 404**

Collettori con quattro attacchi laterali maschio da (W24x19). Conforme secondo il D.M. 174/2004.



Raccordi



CODICE	MISURA	A	B	C	D	E	F	G	H	L			
68542700	G 3/4 x (W24x19)	169	24,5	40	31	W24x19	G 3/4	G 3/4	29	-	303	10	80
68543400	G 1" x (W24x19)	169	24,5	40	38	W24x19	G 1"	G 1"	32,5	-	374	6	48

**COLLETTORI SEMPLICI componibili:
ATTACCO TUBO RAME E TUBO PLASTICA G3/4 EUROCONO**

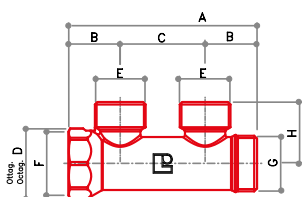

CP 412

Collettori con due attacchi laterali maschio da 3/4 eurocono. Conforme secondo il D.M. 174/2004.

Raccordi



CODICE	MISURA	A	B	C	D	E	F	G	H	L			
68522705	G 3/4 x G 3/4 EK	89	24,5	40	31	G 3/4 EK	G 3/4	G 3/4	29	-	170	15	120
68523405	G 1" x G 3/4 EK	89	24,5	40	38	G 3/4 EK	G 1"	G 1"	32,5	-	210	12	96

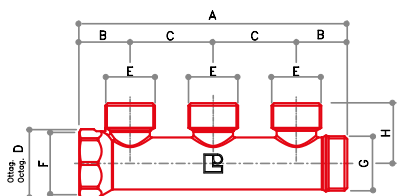

CP 413

Collettori con tre attacchi laterali maschio da 3/4 eurocono. Conforme secondo il D.M. 174/2004.

Raccordi



CODICE	MISURA	A	B	C	D	E	F	G	H	L			
68532705	G 3/4 x G 3/4 EK	129	24,5	40	31	G 3/4 EK	G 3/4	G 3/4	29	-	230	12	96
68533405	G 1" x G 3/4 EK	129	24,5	40	38	G 3/4 EK	G 1"	G 1"	32,5	-	280	8	64

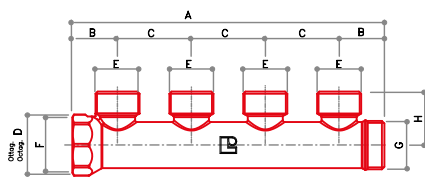

CP 414

Collettori con quattro attacchi laterali maschio da 3/4 eurocono. Conforme secondo il D.M. 174/2004.

Raccordi

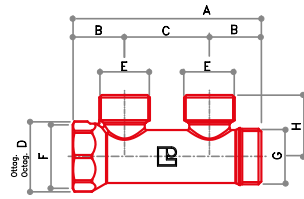

CODICE	MISURA	A	B	C	D	E	F	G	H	L			
68542705	G 3/4 x G 3/4 EK	169	24,5	40	31	G 3/4 EK	G 3/4	G 3/4	29	-	303	10	80
68543405	G 1" x G 3/4 EK	169	24,5	40	38	G 3/4 EK	G 1"	G 1"	32,5	-	340	6	48

**COLLETTORI SEMPLICI COMPONENTI:
ATTACCO TUBO RAME E TUBO PLASTICA G1/2**
**CP 422**

Collettori con due attacchi laterali maschio da 1/2. Conforme secondo il D.M. 174/2004.



Raccordi

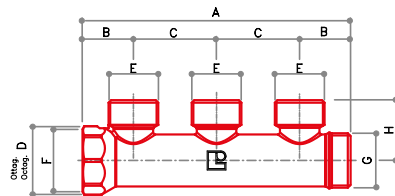

CODICE	MISURA	A	B	C	D	E	F	G	H	L			
68522701	G 3/4 x G 1/2	89	24,5	40	31	G 1/2	G 3/4	G 3/4	29	-	164	15	120
68523401	G 1" x G 1/2	89	24,5	40	38	G 1/2	G 1"	G 1"	32,5	-	210	12	96

**CP 423**

Collettori con tre attacchi laterali maschio da 1/2. Conforme secondo il D.M. 174/2004.



Raccordi

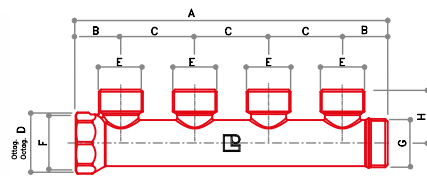

CODICE	MISURA	A	B	C	D	E	F	G	H	L			
68532701	G 3/4 x G 1/2	129	24,5	40	31	G 1/2	G 3/4	G 3/4	29	-	225	12	96
68533401	G 1" x G 1/2	129	24,5	40	38	G 1/2	G 1"	G 1"	32,5	-	275	8	64

**CP 424**

Collettori con quattro attacchi laterali maschio da 1/2. Conforme secondo il D.M. 174/2004.



Raccordi



CODICE	MISURA	A	B	C	D	E	F	G	H	L			
68542701	G 3/4 x G 1/2	169	24,5	40	31	G 1/2	G 3/4	G 3/4	29	-	300	10	80
68543401	G 1" x G 1/2	169	24,5	40	38	G 1/2	G 1"	G 1"	32,5	-	350	6	48

**COLLETTORI SEMPLICI componibili:
ATTACCO TUBO FERRO G1/2**

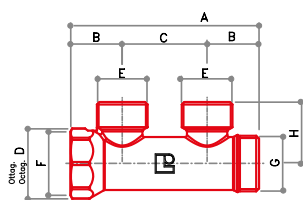

CP 442

Collettori con due attacchi laterali femmina da 1/2. Conforme secondo il D.M. 174/2004.



CODICE	MISURA	A	B	C	D	E	F	G	H	L			
68522702	G 3/4 x G 1/2	89	24,5	40	31	G 1/2	G 3/4	G 3/4	29	-	170	15	120
68523402	G 1" x G 1/2	89	24,5	40	38	G 1/2	G 1"	G 1"	32,5	-	235	12	96

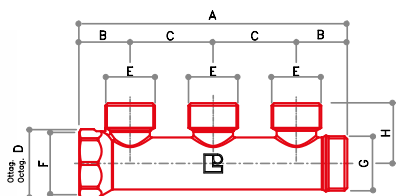

CP 443

Collettori con tre attacchi laterali femmina da 1/2. Conforme secondo il D.M. 174/2004.



CODICE	MISURA	A	B	C	D	E	F	G	H	L			
68532702	G 3/4 x G 1/2	129	24,5	40	31	G 1/2	G 3/4	G 3/4	29	-	230	12	96
68533402	G 1" x G 1/2	129	24,5	40	38	G 1/2	G 1"	G 1"	32,5	-	300	8	64

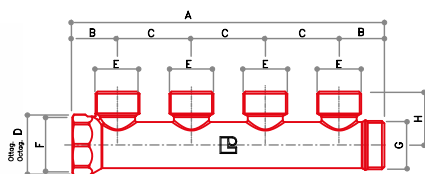

CP 444

Collettori con quattro attacchi laterali femmina da 1/2. Conforme secondo il D.M. 174/2004.



CODICE	MISURA	A	B	C	D	E	F	G	H	L			
68542702	G 3/4 x G 1/2	169	24,5	40	31	G 1/2	G 3/4	G 3/4	29	-	303	10	80
68543402	G 1" x G 1/2	169	24,5	40	38	G 1/2	G 1"	G 1"	32,5	-	420	6	48

DIAGRAMMA DI PORTATA COLLETTORI

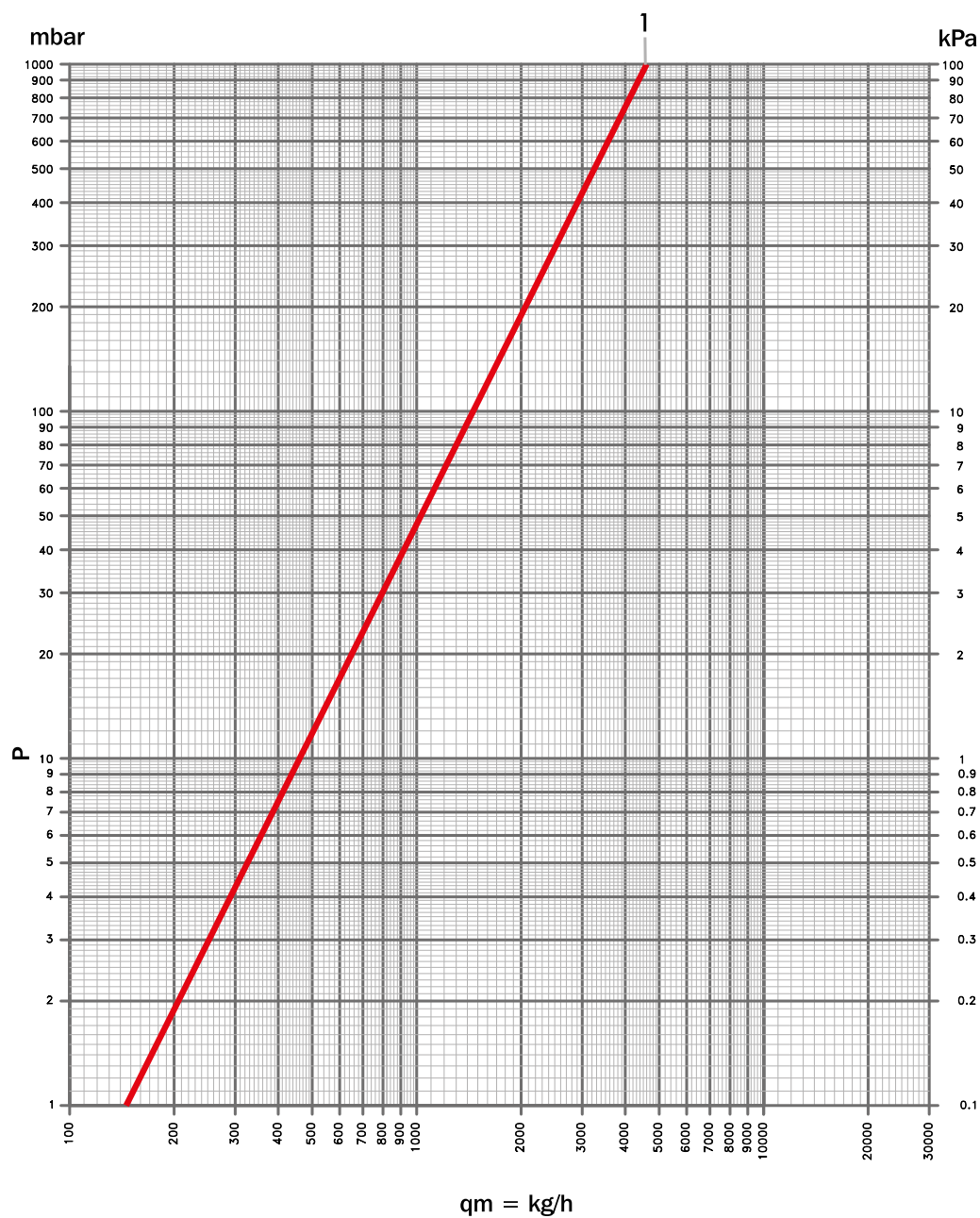

ARTICOLI	MISURA	Kvs	POS
CP 402 CP 403 CP 404 CP 412 CP 413 CP 414	G 3/4	4,6	1
CP 422 CP 423 CP 424 CP 442 CP 443 CP 444	G 1"		

CP

COLLETTORI SEMPLICI COMPONENTI CON VALVOLE DI INTERCETTAZIONE



*Conforme secondo
il D.M. 174/2004

I collettori CP utilizzano un'asta fissa la cui tenuta è garantita da due o-rings e la tenuta in chiusura con l'otturatore è assicurata da una guarnizione piana.

Tutti i collettori vengono forniti con delle etichette che raffigurano le varie utenze.

La lavorazione eseguita dopo il trattamento di nichelatura rende i collettori CP conformi al D.M. 174/2004 per il trasporto di acqua potabile.

Tutti i collettori subiscono un trattamento di distensione del metallo al fine di eliminare eventuali tensioni causate dalla lavorazione.

ATTACCHI IMPIANTO



Max temperatura

120 °C



Max pressione

10 bar



Materiale

CW617N
UNI EN
12165:2016



Manopola

ABS bianco
RAL 9016

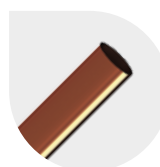

Tubo rame

W 24x19 - TR 91
G 3/4 EK - TR 91/A
G 1/2 - TR 890



Tubo plastica

W 24x19 - TP 95
G 3/4 EK - TP 98
G 1/2 - TP 93



Tubo multistrato

W 24x19 - TP 97
G 3/4 EK - TP 99
G 1/2 - TP 96

ATTACCO CORPO PRINCIPALE



G 3/4
G 1"

INTERASSI



40 mm



Le uscite dei collettori sono disassate di 4 mm per facilitare l'assemblaggio dei raccordi nella cassetta.

Le caratteristiche del fluido dell'impianto devono essere conformi alla direttiva UNI 8065:2019.

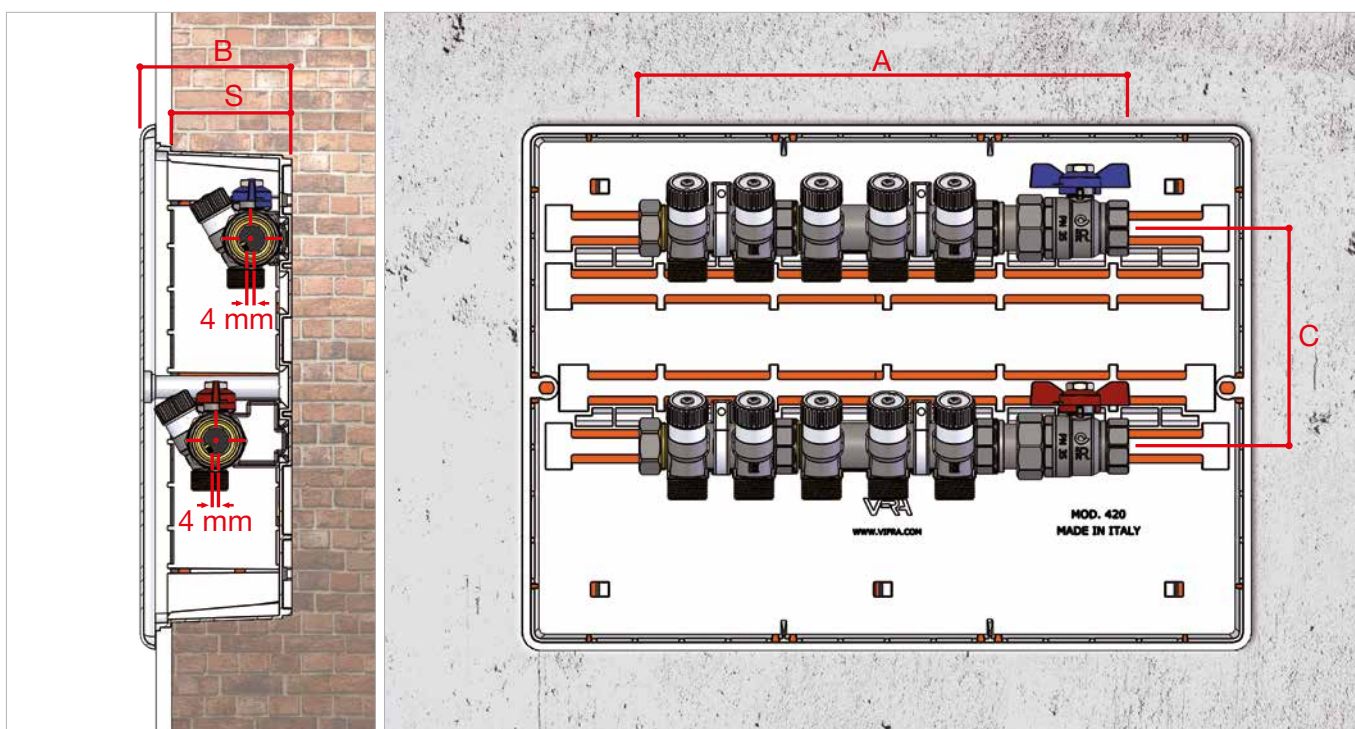

Nella tabella di seguito sono riportate tutte le misure degli ingombri relativi alla combinazione di due collettori semplici componibili con una valvola a sfera a passaggio totale.

Con l'aiuto di tali misure e prevedendo di lasciare circa 50 mm di spazio libero dalla parte della valvola a sfera, è possibile scegliere la cassetta da incasso in plastica con i relativi sistemi di fissaggio con staffe precostituite di cui si riportano le misure esterne.

		CF 477						CF 479				
N. VIE	Ø	A	B	C	S	CASSETTE	DIMENSIONE CASSETTE	B	C	S	CASSETTE	DIMENSIONE CASSETTE
2	G 3/4	175	100	110	86	68560432	272 x 332 x 86	98	140	88	68560332	290 x 330 x 88
3	G 3/4	215	100	110	86	68560432	272 x 332 x 86	98	140	88	68560332	290 x 330 x 88
4	G 3/4	255	100	110	86	68560432	272 x 332 x 86	98	140	88	68560332	290 x 330 x 88
3 + 2	G 3/4	295	100	110	86	68560440	272 x 412 x 86	98	130	88	68560342	310 x 430 x 88
3 + 3	G 3/4	335	100	110	86	68560440	272 x 412 x 86	98	130	88	68560342	310 x 430 x 88
3 + 4	G 3/4	375	100	110	86	68560450	272 x 512 x 86	98	150	88	68560352	330 x 530 x 88
4 + 4	G 3/4	415	100	110	86	68560450	272 x 512 x 86	98	150	88	68560352	330 x 530 x 88
2	G 1"	175	100	110	86	68560432	272 x 332 x 86	98	140	88	68560332	290 x 330 x 88
3	G 1"	215	100	110	86	68560432	272 x 332 x 86	98	140	88	68560332	290 x 330 x 88
4	G 1"	255	100	110	86	68560440	272 x 412 x 86	98	130	88	68560342	310 x 430 x 88
3 + 2	G 1"	295	100	110	86	68560440	272 x 412 x 86	98	130	88	68560342	310 x 430 x 88
3 + 3	G 1"	335	100	110	86	68560440	272 x 412 x 86	98	130	88	68560342	310 x 430 x 88
3 + 4	G 1"	375	100	110	86	68560450	272 x 512 x 86	98	150	88	68560352	330 x 530 x 88
4 + 4	G 1"	415	100	110	86	68560450	272 x 512 x 86	98	150	88	68560352	330 x 530 x 88

**COLLETTORI SEMPLICI COMPONIBILI CON VALVOLE DI INTERCETTAZIONE:
ATTACCO TUBO RAME E TUBO PLASTICA W24x19**

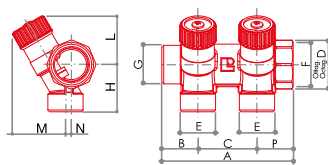

CP 432

Collettore semplice componibile a 2 vie con valvole di intercettazione. Attacco tubo rame e tubo plastica (W24x19). Conforme secondo il D.M. 174/2004.

Raccordi



CODICE	MISURA	A	B	C	D	E	F	G	H	L	M	N	P	⊙	📦	📦
68512702	G 3/4 x (W24x19)	91,5	25	40	31	W24x19	G 3/4	G 3/4	32	34	36	4	26,5	300	6	48
68513402	G 1" x (W24x19)	91	24,5	40	38	W24x19	G 1"	G 1"	34	36	40	3	26,5	320	5	40

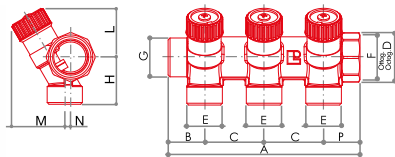

CP 433

Collettore semplice componibile a 3 vie con valvole di intercettazione. Attacco tubo rame e tubo plastica (W24x19). Conforme secondo il D.M. 174/2004.

Raccordi



CODICE	MISURA	A	B	C	D	E	F	G	H	L	M	N	P	⊙	📦	📦
68512703	G 3/4 x (W24x19)	131,5	25	40	31	W24x19	G 3/4	G 3/4	32	34	36	4	26,5	432	5	40
68513403	G 1" x (W24x19)	131	24,5	40	38	W24x19	G 1"	G 1"	34	36	40	3	26,5	458	4	32

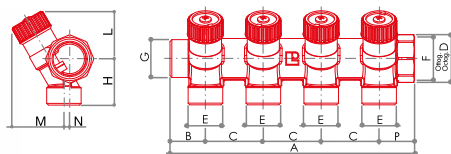

CP 434

Collettore semplice componibile a 4 vie con valvole di intercettazione. Attacco tubo rame e tubo plastica (W24x19). Conforme secondo il D.M. 174/2004.

Raccordi

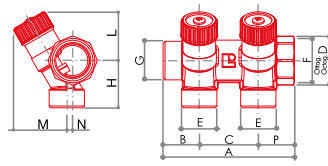

CODICE	MISURA	A	B	C	D	E	F	G	H	L	M	N	P	⊙	📦	📦
68512704	G 3/4 x (W24x19)	171,5	25	40	31	W24x19	G 3/4	G 3/4	32	34	36	4	26,5	562	4	32
68513404	G 1" x (W24x19)	171	24,5	40	38	W24x19	G 1"	G 1"	34	36	40	3	26,5	640	3	24

**COLLETTORI SEMPLICI COMPONENTI CON VALVOLE DI INTERCETTAZIONE:
ATTACCO TUBO RAME E TUBO PLASTICA G3/4 EUROCONO**
**CP 452**

Collettore semplice componibile a 2 vie con valvole di intercettazione. Attacco tubo rame e tubo plastica G 3/4 EK. Conforme secondo il D.M. 174/2004.

Raccordi

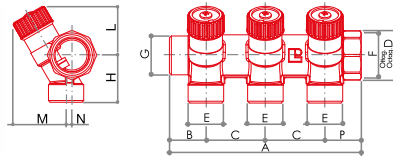

CODICE	MISURA	A	B	C	D	E	F	G	H	L	M	N	P			
68512802	G 3/4 x G 3/4 EK	91,5	25	40	31	G 3/4 EK	G 3/4	G 3/4	32	34	36	4	26,5	309	6	48
68513502	G 1" x G 3/4 EK	91	24,5	40	38	G 3/4 EK	G 1"	G 1"	34	36	40	3	26,5	337	5	40

**CP 453**

Collettore semplice componibile a 3 vie con valvole di intercettazione. Attacco tubo rame e tubo plastica G 3/4 EK. Conforme secondo il D.M. 174/2004.

Raccordi

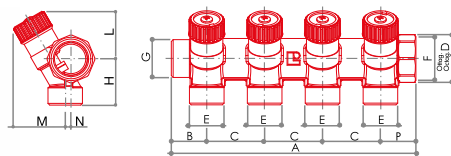

CODICE	MISURA	A	B	C	D	E	F	G	H	L	M	N	P			
68512803	G 3/4 x G 3/4 EK	131,5	25	40	31	G 3/4 EK	G 3/4	G 3/4	32	34	36	4	26,5	430	5	40
68513503	G 1" x G 3/4 EK	131	24,5	40	38	G 3/4 EK	G 1"	G 1"	34	36	40	3	26,5	490	4	32

**CP 454**

Collettore semplice componibile a 4 vie con valvole di intercettazione. Attacco tubo rame e tubo plastica G 3/4 EK. Conforme secondo il D.M. 174/2004.

Raccordi



CODICE	MISURA	A	B	C	D	E	F	G	H	L	M	N	P			
68512804	G 3/4 x G 3/4 EK	171,5	25	40	31	G 3/4 EK	G 3/4	G 3/4	32	34	36	4	26,5	562	4	32
68513504	G 1" x G 3/4 EK	171	24,5	40	38	G 3/4 EK	G 1"	G 1"	34	36	40	3	26,5	640	3	24

**COLLETTORI SEMPLICI COMPONIBILI CON VALVOLE DI INTERCETTAZIONE:
ATTACCO TUBO RAME E TUBO PLASTICA G1/2**

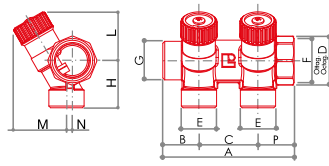

CP 462

Collettore semplice componibile a 2 vie con valvole di intercettazione. Attacco tubo rame e tubo plastica G 1/2. Conforme secondo il D.M. 174/2004.

Raccordi



CODICE	MISURA	A	B	C	D	E	F	G	H	L	M	N	P	⊗	⊞	⊠
68512602	G 3/4 x G 1/2	91,5	25	40	31	G 1/2	G 3/4	G 3/4	32	34	36	4	26,5	309	6	48
68513302	G 1" x G 1/2	91	24,5	40	38	G 1/2	G 1"	G 1"	34	36	40	3	26,5	335	5	40

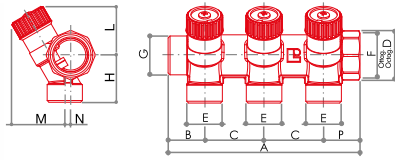

CP 463

Collettore semplice componibile a 3 vie con valvole di intercettazione. Attacco tubo rame e tubo plastica G 1/2. Conforme secondo il D.M. 174/2004.

Raccordi



CODICE	MISURA	A	B	C	D	E	F	G	H	L	M	N	P	⊗	⊞	⊠
68512603	G 3/4 x G 1/2	131,5	25	40	31	G 1/2	G 3/4	G 3/4	32	34	36	4	26,5	430	5	40
68513303	G 1" x G 1/2	131	24,5	40	38	G 1/2	G 1"	G 1"	34	36	40	3	26,5	487	4	32

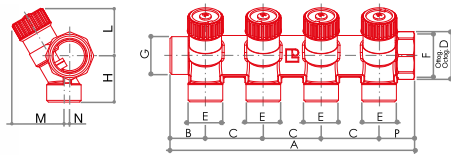

CP 464

Collettore semplice componibile a 4 vie con valvole di intercettazione. Attacco tubo rame e tubo plastica G 1/2. Conforme secondo il D.M. 174/2004.

Raccordi



CODICE	MISURA	A	B	C	D	E	F	G	H	L	M	N	P	⊗	⊞	⊠
68512604	G 3/4 x G 1/2	171,5	25	40	31	G 1/2	G 3/4	G 3/4	32	34	36	4	26,5	562	4	32
68513304	G 1" x G 1/2	171	24,5	40	38	G 1/2	G 1"	G 1"	34	36	40	3	26,5	636	3	24

**IU 436**

Etichetta con indicazioni utenze per collettori sanitari.

CODICE	MISURA			
ETICHCS	-	-	-	-

**IU 437**

Coppia di dischetti in alluminio rosso/blu ed indicazione utenze per collettori sanitari.

CODICE	MISURA			
6801615	-	1	-	-

**571**

Volantino in ABS di colore bianco RAL 9016 per collettori serie CP.

CODICE	MISURA			
4761624	-	4	-	-

**580**

Vite ferma volantino in ottone per valvole serie Tekna.

CODICE	MISURA			
9346615	-	1	-	-

DIAGRAMMA DI PORTATA COLLETTORI

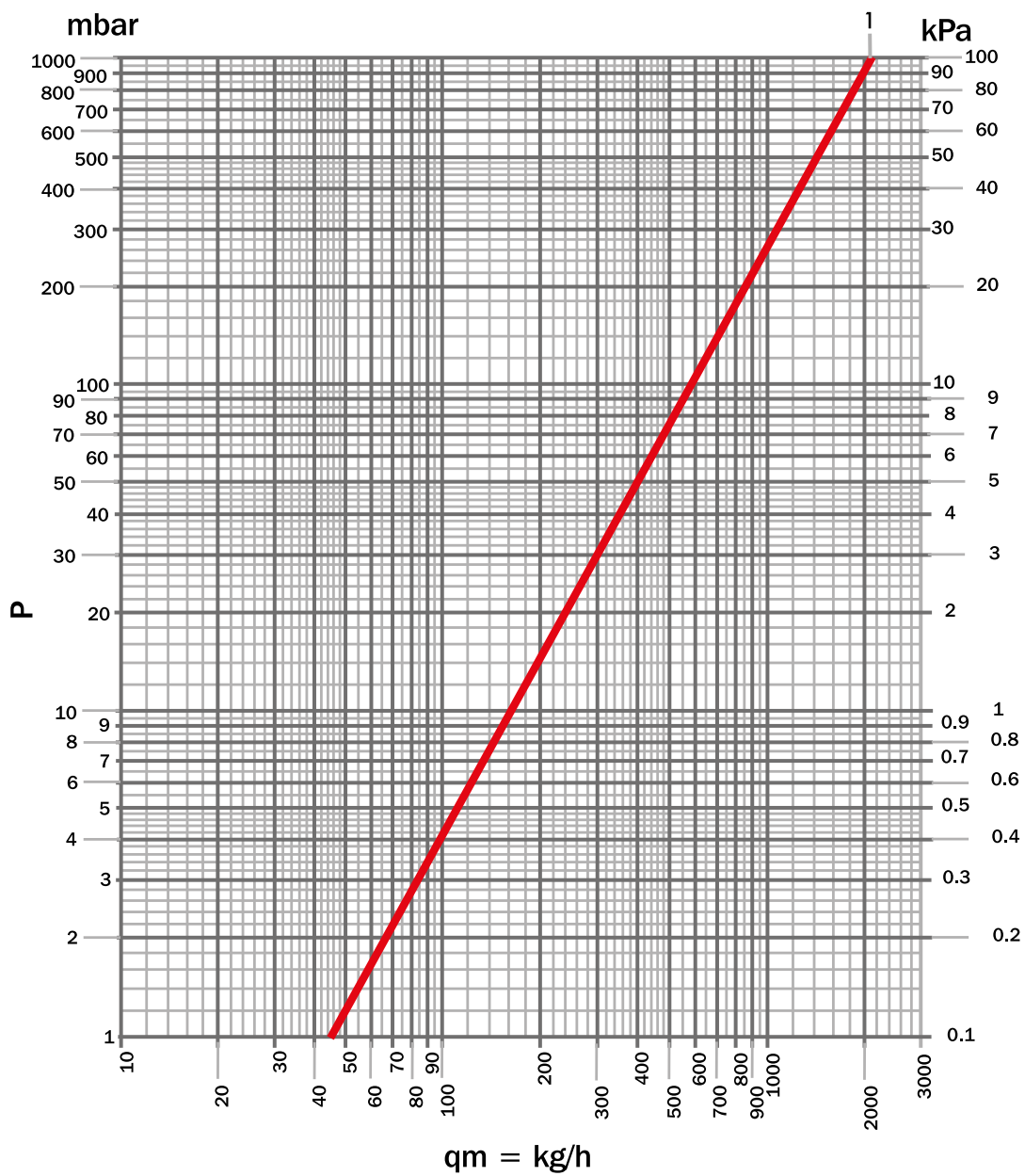

ARTICOLI	MISURA	N. GIRI	Kvs	POS
CP 432 CP 433 CP 434 CP 452 CP 453 CP 454 CP 462 CP 463 CP 464	G 3/4	tutto aperto	2,1	1
	G 1"			

CP

COLLETTORI SEMPLICI COMPONENTI CON FILETTI IN FASE E VALVOLE DI INTERCETTAZIONE



*Conforme secondo il D.M. 174/2004

I collettori CP utilizzano un'asta fissa la cui tenuta è garantita da due o-rings e la tenuta in chiusura con l'otturatore è assicurata da una guarnizione piana.

Tutti i collettori vengono forniti con delle etichette che raffigurano le varie utenze.

La lavorazione eseguita dopo il trattamento di nichelatura rende i collettori CP conformi al D.M. 174/2004 per il trasporto di acqua potabile.

Tutti i collettori subiscono un trattamento di distensione del metallo al fine di eliminare eventuali tensioni causate dalla lavorazione.

CARATTERISTICHE TECNICHE



Max temperatura

120 °C



Max pressione

10 bar



Materiale

CW617N
UNI EN
12165:2016



Manopola

ABS bianco
RAL 9016

ATTACCHI IMPIANTO

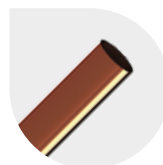

Tubo rame

W 24x19 - TR 91
G 3/4 EK - TR 91/A
G 1/2 - TR 890



Tubo plastica

W 24x19 - TP 95
G 3/4 EK - TP 98
G 1/2 - TP 93



Tubo multistrato

W 24x19 - TP 97
G 3/4 EK - TP 99
G 1/2 - TP 96

ATTACCO CORPO PRINCIPALE



G 3/4
G 1"

INTERASSI



40 mm



Le uscite dei collettori sono disassate di 4 mm per facilitare l'assemblaggio dei raccordi nella cassetta.

ALLINEAMENTO AUTOMATICO

I collettori CP con filetti in fase si collegano tra loro in modo semplice e intuitivo. Grazie alla fasatura dei filetti, i collettori CP risultano sempre allineati e la tenuta è garantita da una guarnizione O-ring.

I collettori non necessitano quindi di alcun elemento intermedio di sigillatura (come ptfе, canapa, ecc) velocizzando l'installazione.

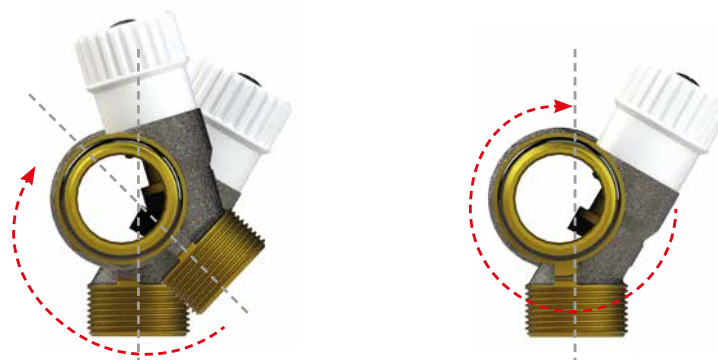

Le caratteristiche del fluido dell'impianto devono essere conformi alla direttiva UNI 8065:2019.

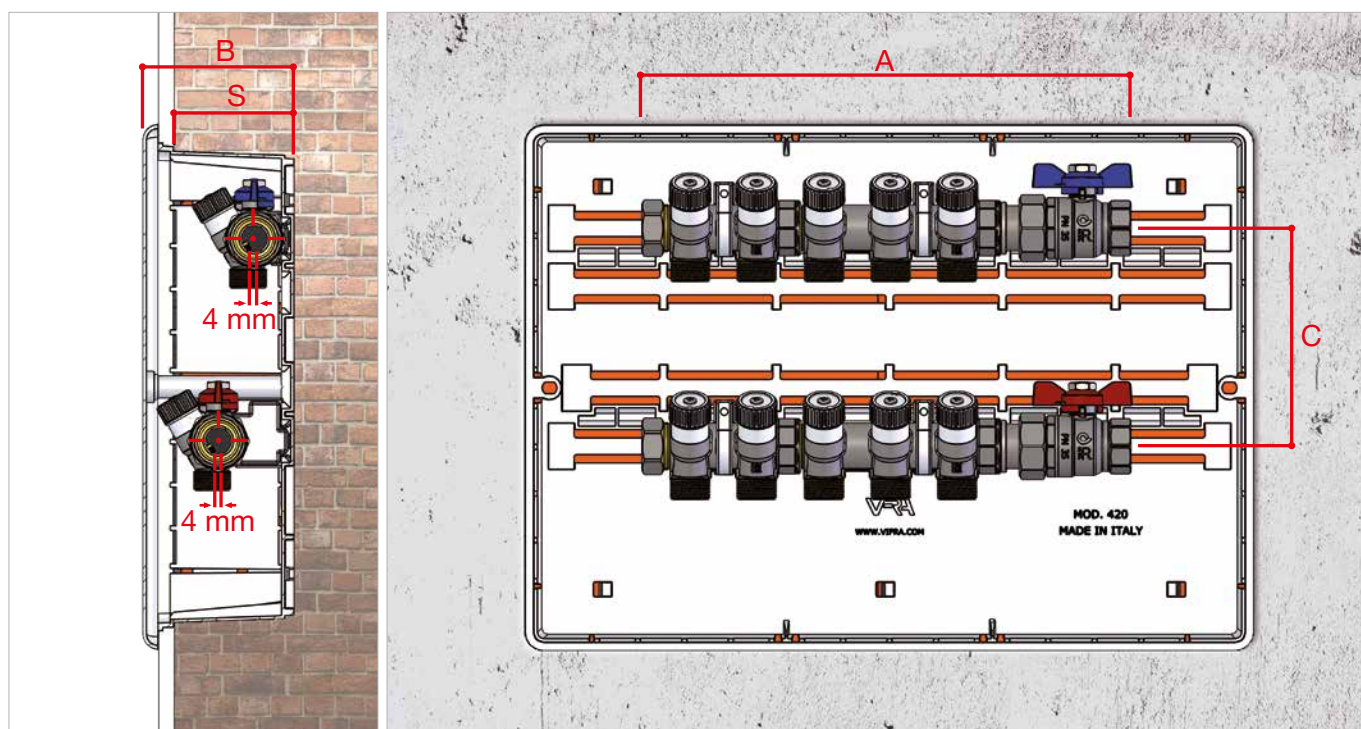

Nella tabella di seguito sono riportate tutte le misure degli ingombri relativi alla combinazione di due collettori semplici componibili con una valvola a sfera a passaggio totale.

Con l'aiuto di tali misure e prevedendo di lasciare circa 50 mm di spazio libero dalla parte della valvola a sfera, è possibile scegliere la cassetta da incasso in plastica con i relativi sistemi di fissaggio con staffe precostituite di cui si riportano le misure esterne.

CF 477								CF 479				
N. VIE	Ø	A	B	C	S	CASSETTE	DIMENSIONE CASSETTE	B	C	S	CASSETTE	DIMENSIONE CASSETTE
2	G 3/4	175	100	110	86	68560432	272 x 332 x 86	98	140	88	68560332	290 x 330 x 88
3	G 3/4	215	100	110	86	68560432	272 x 332 x 86	98	140	88	68560332	290 x 330 x 88
4	G 3/4	255	100	110	86	68560432	272 x 332 x 86	98	140	88	68560332	290 x 330 x 88
3 + 2	G 3/4	295	100	110	86	68560440	272 x 412 x 86	98	130	88	68560342	310 x 430 x 88
3 + 3	G 3/4	335	100	110	86	68560440	272 x 412 x 86	98	130	88	68560342	310 x 430 x 88
3 + 4	G 3/4	375	100	110	86	68560450	272 x 512 x 86	98	150	88	68560352	330 x 530 x 88
4 + 4	G 3/4	415	100	110	86	68560450	272 x 512 x 86	98	150	88	68560352	330 x 530 x 88
2	G 1"	175	100	110	86	68560432	272 x 332 x 86	98	140	88	68560332	290 x 330 x 88
3	G 1"	215	100	110	86	68560432	272 x 332 x 86	98	140	88	68560332	290 x 330 x 88
4	G 1"	255	100	110	86	68560440	272 x 412 x 86	98	130	88	68560342	310 x 430 x 88
3 + 2	G 1"	295	100	110	86	68560440	272 x 412 x 86	98	130	88	68560342	310 x 430 x 88
3 + 3	G 1"	335	100	110	86	68560440	272 x 412 x 86	98	130	88	68560342	310 x 430 x 88
3 + 4	G 1"	375	100	110	86	68560450	272 x 512 x 86	98	150	88	68560352	330 x 530 x 88
4 + 4	G 1"	415	100	110	86	68560450	272 x 512 x 86	98	150	88	68560352	330 x 530 x 88

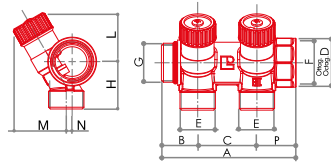
**COLLETTORI SEMPLICI COMPONENTI CON FILETTI IN FASE E VALVOLE DI INTERCETTAZIONE:
ATTACCO TUBO RAME E TUBO PLASTICA W24X19**
**CP 432/FR**

Collettore semplice componibile con filetti in fase a 2 vie con valvole di intercettazione. Attacco tubo rame e tubo plastica (W24x19). Conforme secondo il D.M. 174/2004.

Raccordi

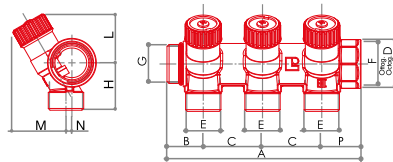

CODICE	MISURA	A	B	C	D	E	F	G	H	L	M	N	P			
68512702FR	G 3/4 x (W24x19)	91	24,5	40	31	W24x19	G 3/4	G 3/4	32	34	36	4	26,5	305	6	48
68513402FR	G 1" x (W24x19)	91,5	24,5	40	38	W24x19	G 1"	G 1"	34	36	40	3	27	325	5	40

**CP 433/FR**

Collettore semplice componibile con filetti in fase a 3 vie con valvole di intercettazione. Attacco tubo rame e tubo plastica (W24x19). Conforme secondo il D.M. 174/2004.

Raccordi

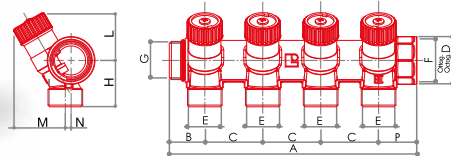

CODICE	MISURA	A	B	C	D	E	F	G	H	L	M	N	P			
68512703FR	G 3/4 x (W24x19)	131	24,5	40	31	W24x19	G 3/4	G 3/4	32	34	36	4	26,5	437	5	40
68513403FR	G 1" x (W24x19)	131,5	24,5	40	38	W24x19	G 1"	G 1"	34	36	40	3	27	463	4	32

**CP 434/FR**

Collettore semplice componibile con filetti in fase a 4 vie con valvole di intercettazione. Attacco tubo rame e tubo plastica (W24x19). Conforme secondo il D.M. 174/2004.

Raccordi



CODICE	MISURA	A	B	C	D	E	F	G	H	L	M	N	P			
68512704FR	G 3/4 x (W24x19)	171	24,5	40	31	W24x19	G 3/4	G 3/4	32	34	36	4	26,5	567	4	32
68513404FR	G 1" x (W24x19)	171,5	24,5	40	38	W24x19	G 1"	G 1"	34	36	40	3	27	645	3	24

**COLLETTORI SEMPLICI COMPONIBILI CON FILETTI IN FASE E VALVOLE DI INTERCETTAZIONE:
ATTACCO TUBO RAME E TUBO PLASTICA G3/4 EUROCONO**

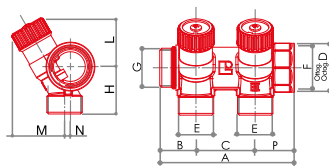

CP 452/FR

Collettore semplice componibile con filetti in fase a 2 vie con valvole di intercettazione. Attacco tubo rame e tubo plastica G 3/4 EK. Conforme secondo il D.M. 174/2004.

Raccordi



CODICE	MISURA	A	B	C	D	E	F	G	H	L	M	N	P			
68512802FR	G 3/4 x G 3/4 EK	91	24,5	40	31	G 3/4 EK	G 3/4	G 3/4	32	34	36	4	26,5	325	6	48
68513502FR	G 1" x G 3/4 EK	91,5	24,5	40	38	G 3/4 EK	G 1"	G 1"	34	36	40	3	27	342	5	40

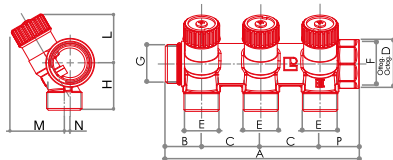

CP 453/FR

Collettore semplice componibile con filetti in fase a 3 vie con valvole di intercettazione. Attacco tubo rame e tubo plastica G 3/4 EK. Conforme secondo il D.M. 174/2004.

Raccordi



CODICE	MISURA	A	B	C	D	E	F	G	H	L	M	N	P			
68512803FR	G 3/4 x G 3/4 EK	131	24,5	40	31	G 3/4 EK	G 3/4	G 3/4	32	34	36	4	26,5	435	5	40
68513503FR	G 1" x G 3/4 EK	131,5	24,5	40	38	G 3/4 EK	G 1"	G 1"	34	36	40	3	27	495	4	32

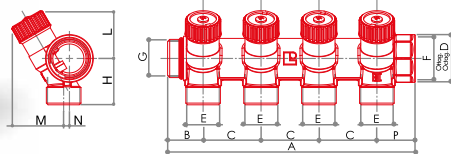

CP 454/FR

Collettore semplice componibile con filetti in fase a 4 vie con valvole di intercettazione. Attacco tubo rame e tubo plastica G 3/4 EK. Conforme secondo il D.M. 174/2004.

Raccordi

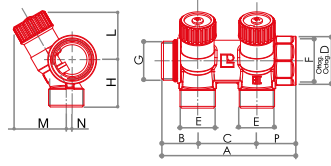

CODICE	MISURA	A	B	C	D	E	F	G	H	L	M	N	P			
68512804FR	G 3/4 x G 3/4 EK	171	24,5	40	31	G 3/4 EK	G 3/4	G 3/4	32	34	36	4	26,5	567	4	32
68513504FR	G 1" x G 3/4 EK	171,5	24,5	40	38	G 3/4 EK	G 1"	G 1"	34	36	40	3	27	645	3	24

**COLLETTORI SEMPLICI COMPONIBILI CON FILETTI IN FASE E VALVOLE DI INTERCETTAZIONE:
ATTACCO TUBO RAME E TUBO PLASTICA G1/2**
**CP 462/FR**

Collettore semplice componibile con filetti in fase a 2 vie con valvole di intercettazione. Attacco tubo rame e tubo plastica G 1/2. Conforme secondo il D.M. 174/2004.

Raccordi

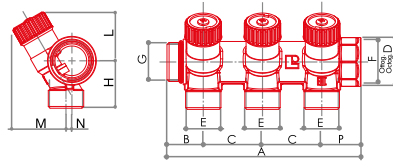

CODICE	MISURA	A	B	C	D	E	F	G	H	L	M	N	P			
68512602FR	G 3/4 x G 1/2	91	24,5	40	31	G 1/2	G 3/4	G 3/4	32	34	36	4	26,5	314	6	48
68513302FR	G 1" x G 1/2	91,5	24,5	40	38	G 1/2	G 1"	G 1"	34	36	40	3	27	340	5	40

**CP 463/FR**

Collettore semplice componibile con filetti in fase a 3 vie con valvole di intercettazione. Attacco tubo rame e tubo plastica G 1/2. Conforme secondo il D.M. 174/2004.

Raccordi

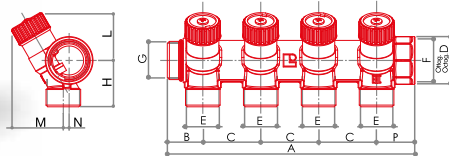

CODICE	MISURA	A	B	C	D	E	F	G	H	L	M	N	P			
68512603FR	G 3/4 x G 1/2	131	24,5	40	31	G 1/2	G 3/4	G 3/4	32	34	36	4	26,5	435	5	40
68513303FR	G 1" x G 1/2	131,5	24,5	40	38	G 1/2	G 1"	G 1"	34	36	40	3	27	492	4	32

**CP 464/FR**

Collettore semplice componibile con filetti in fase a 4 vie con valvole di intercettazione. Attacco tubo rame e tubo plastica G 1/2. Conforme secondo il D.M. 174/2004.

Raccordi



CODICE	MISURA	A	B	C	D	E	F	G	H	L	M	N	P			
68512604FR	G 3/4 x G 1/2	171	24,5	40	31	G 1/2	G 3/4	G 3/4	32	34	36	4	26,5	567	4	32
68513304FR	G 1" x G 1/2	171,5	24,5	40	38	G 1/2	G 1"	G 1"	34	36	40	3	27	641	3	24

DIAGRAMMA DI PORTATA COLLETTORI

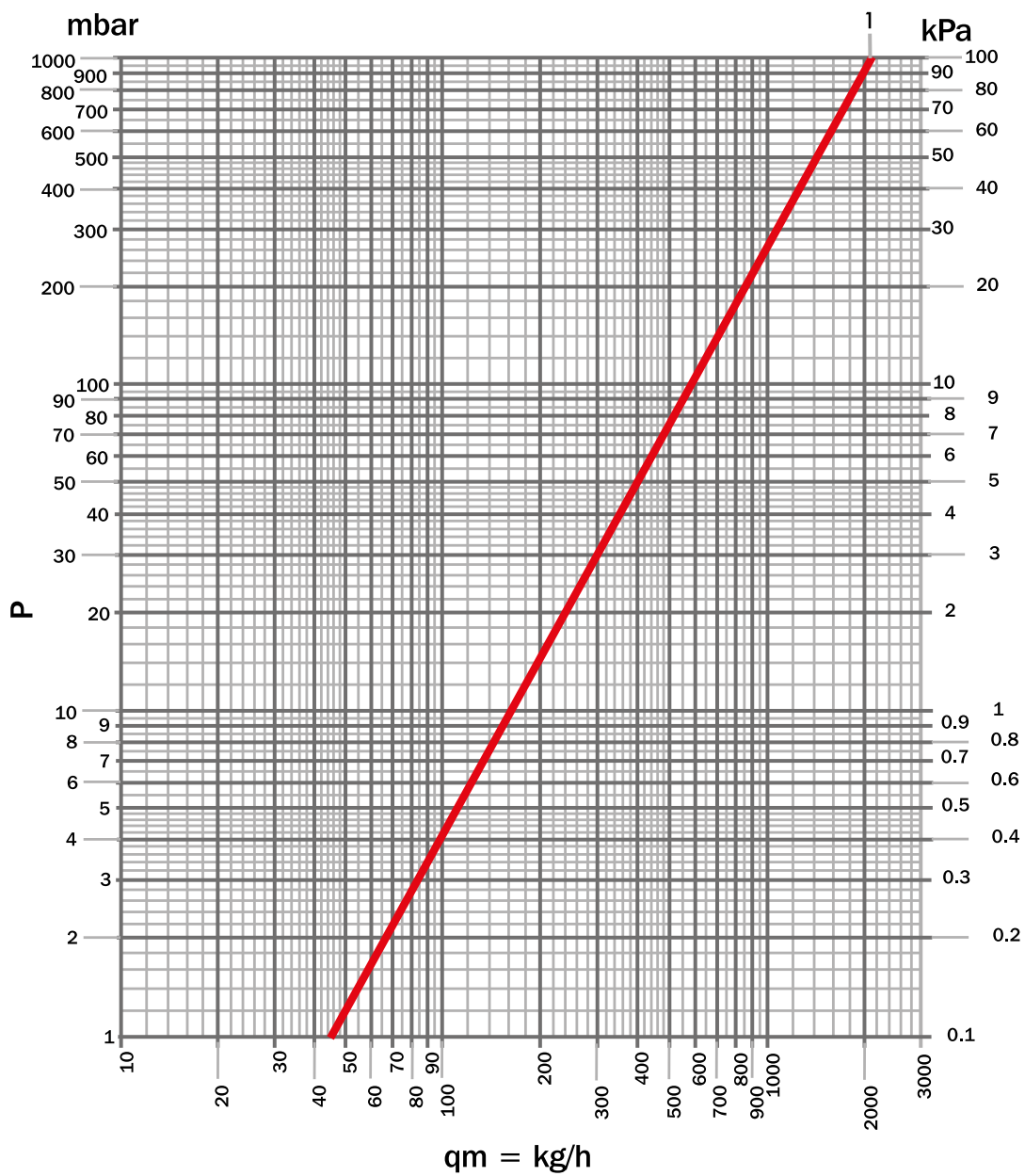

ARTICOLI	MISURA	N. GIRI	Kvs	POS
CP 432/FR CP 433/FR CP 434/FR CP 452/FR CP 453/FR CP 454/FR CP 462/FR CP 463/FR CP 464/FR	G 3/4	tutto aperto	2,1	1
	G 1"			



COLLETTORI COMPLANARI

2.2 / SERIE CC

CC

COLLETTORI COMPLANARI



Tutti i collettori della serie CC con i relativi accessori sono prodotti con finitura nichelata. I corpi dei collettori sono ottenuti da fusione e utilizzano ot-

tone EN 1982, con un basso contenuto di piombo. I collegamenti interni dei circuiti permettono il passaggio di portate elevate con bassissima rumorosità.

CARATTERISTICHE TECNICHE



Max temperatura

120 °C



Max pressione

10 bar



Materiale

EN 1982

ATTACCHI IMPIANTO

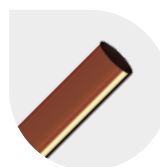

Tubo rame

W 24x19 - TR 91
G 3/4 EK - TR 91/A



Tubo plastica

W 24x19 - TP 95
G 3/4 EK - TP 98



Tubo multistrato

W 24x19 - TP 97
G 3/4 EK - TP 99

ATTACCO CORPO PRINCIPALE



G 3/4
G 1"

INTERASSI

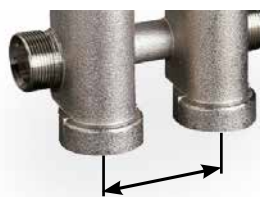

G 1" 50 mm
G 1 1/4 55 mm



38 mm

DISTRIBUZIONE

I collettori complanari sono adatti per la distribuzione dell'acqua negli impianti di riscaldamento con distribuzione orizzontale di tipo a raggiera. Infatti gli attacchi dei circuiti sono sfalsati per la mandata e il ritorno: questo permette un agevole collegamento dei circuiti senza sovrapposizione delle tubature della mandata e del ritorno.

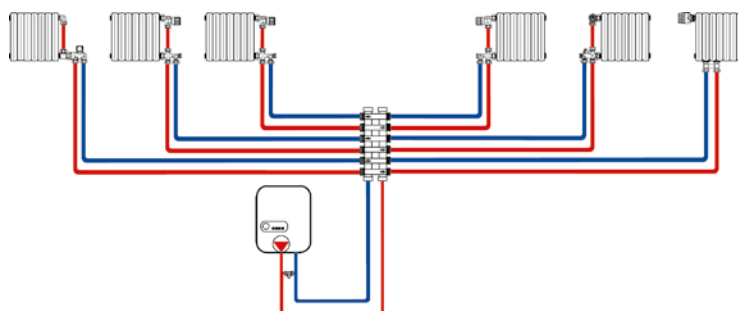

Le caratteristiche del fluido dell'impianto devono essere conformi alla direttiva UNI 8065:2019.

COLLETTORI COMPLANARI

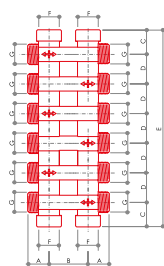
**CC 414**

Collettore complanare con attacchi laterali maschio da (W24x19).

Raccordi

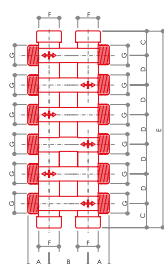

CODICE	MISURA	N. VIE	A	B	C	D	E	F	G	H	L			
68542704	G 3/4 x (W24x19)	4 + 4	27	50	26	38	166	G 3/4	W24x19	-	-	1300	1	18
68542706		6 + 6	27	50	26	38	242	G 3/4	W24x19	-	-	2030	1	12
68542708		8 + 8	27	50	26	38	318	G 3/4	W24x19	-	-	2408	1	9

**CC 416**

Collettore complanare con attacchi laterali maschio da 3/4 eurocono.

Raccordi

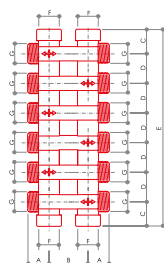

CODICE	MISURA	N. VIE	A	B	C	D	E	F	G	H	L			
68542714	G 3/4 x G 3/4 EK	4 + 4	27	50	26	38	166	G 3/4	G 3/4 EK	-	-	1300	1	18
68542716		6 + 6	27	50	26	38	242	G 3/4	G 3/4 EK	-	-	2030	1	12
68542718		8 + 8	27	50	26	38	318	G 3/4	G 3/4 EK	-	-	2408	1	9

**CC 413**

Collettore complanare con attacchi laterali maschio da (W24x19).

Raccordi

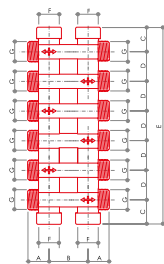

CODICE	MISURA	N. VIE	A	B	C	D	E	F	G	H	L			
68543406	G 1" x (W24x19)	6 + 6	30	55	30	38	250	G 1"	W24x19	-	-	2330	1	12
68543408		8 + 8	30	55	30	38	326	G 1"	W24x19	-	-	3248	1	9
68543410		10 + 10	30	55	30	38	402	G 1"	W24x19	-	-	4026	1	8

**CC 415**

Collettore complanare con attacchi laterali maschio da 3/4 eurocono.

Raccordi



CODICE	MISURA	N. VIE	A	B	C	D	E	F	G	H	L			
68543416	G 1" x G 3/4 EK	6 + 6	30	55	30	38	250	G 1"	G 3/4 EK	-	-	2330	1	12
68543418		8 + 8	30	55	30	38	326	G 1"	G 3/4 EK	-	-	3248	1	9
68543420		10 + 10	30	55	30	38	402	G 1"	G 3/4 EK	-	-	4026	1	8



Raccordi per tubo rame



Raccordi per tubo plastica



Raccordi per tubo multistrato



Raccordi: capitolo 7



Accessori: capitolo 2.A

DIAGRAMMA DI PORTATA COLLETTORI

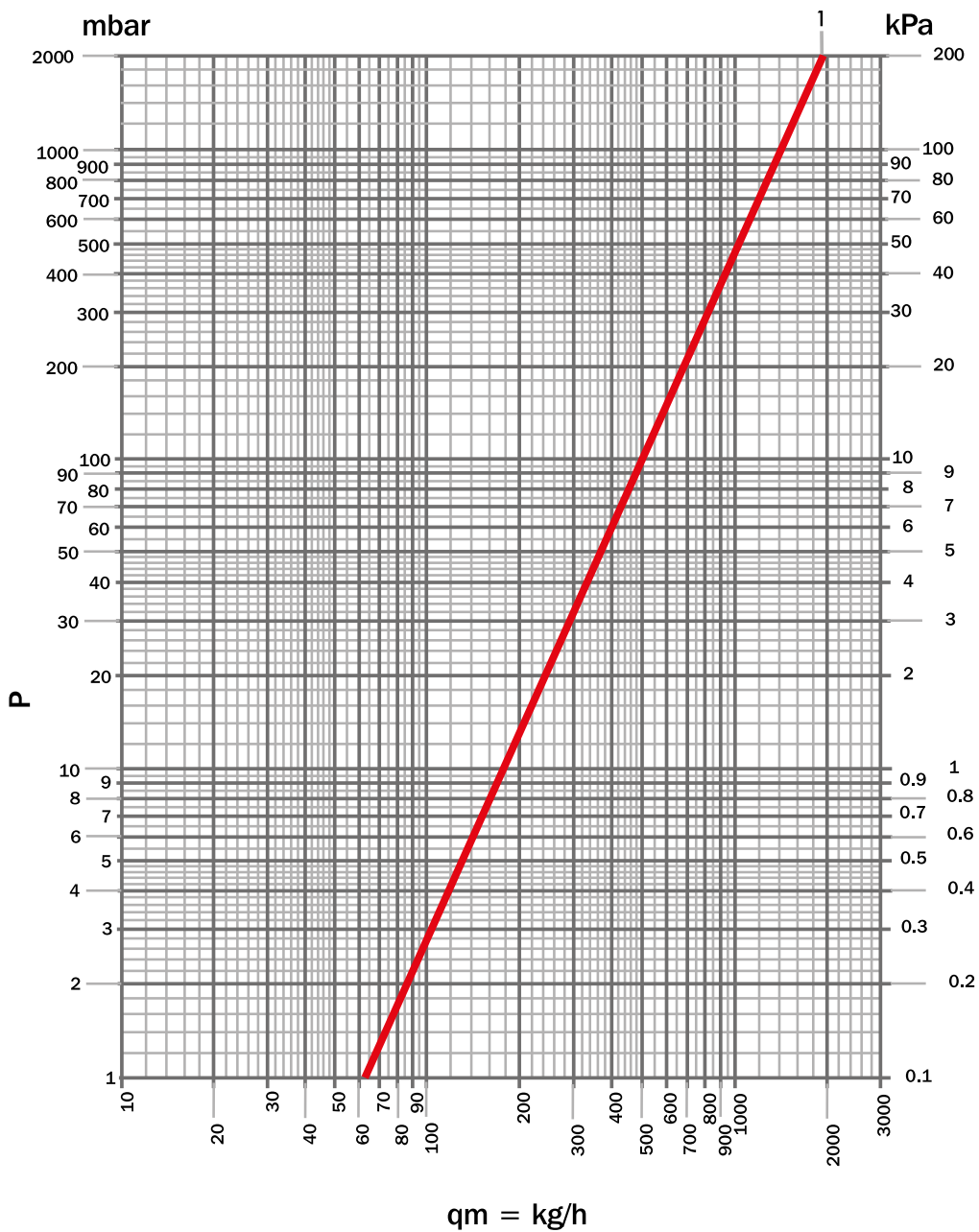

ARTICOLI	MISURA	N. VIE	Kvs	POS
CC 414 CC 416	G 3/4	4 + 4	1,96	1
		6 + 6		
		8 + 8		
CC 413 CC 415	G 1"	6 + 6		
		8 + 8		
		10 + 10		



COLLETTORI DI DISTRIBUZIONE

2.3 / SERIE CD

CD

COLLETTORI DI DISTRIBUZIONE PER IMPIANTI DI RISCALDAMENTO



*Conforme secondo il D.M. 174/2004

I collettori serie CD sono ricavati da barra d'ottone trafilata con finitura gialla* o nichelata.

Tutti i collettori subiscono un trattamento di distensione del metallo al fine di eliminare eventuali tensioni causate dalla lavorazione. Sui collettori di nostra produzione utilizzare solo accessori LUXOR che abbiano una tenuta morbida con guarnizione.

Tutta la raccorderia e gli accessori dei collettori (valvole di scarico, terminali, tappi, ecc) sono dotati di tale tenuta e non necessitano di alcun elemento intermedio di sigillatura (come ptfе, canapa, ecc) il cui utilizzo potrebbe causare l'insorgere di cricche.

Si consiglia di serrare la raccorderia ad una coppia massima di 60 Nm.

CARATTERISTICHE TECNICHE



Max temperatura
120 °C



Max pressione
10 bar



Materiale
CW617N
UNI EN
12165:2016



Manopola
ABS bianco
RAL 9016



Asta di comando
AISI 316



Collaudo
100%

ATTACCHI IMPIANTO

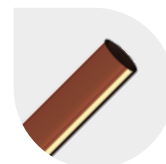

Tubo rame
W 24x19 - TR 91
G 3/4 EK - TR 91/A

CARATTERISTICHE TECNICHE CON REGOLATORI MISURATORI DI PORTATA ART. TM 4012



Max temperatura
70 °C



Max pressione
6 bar



Temperatura fluido
0 °C ÷ 100 °C



Temperatura ambiente
0 °C ÷ 60 °C



Max umidità relativa
80%

CARATTERISTICHE TECNICHE CON TESTE TERMoeLETRICHE ART. TE



Tubo plastica
W 24x19 - TP 95
G 3/4 EK - TP 98

ATTACCO CORPO PRINCIPALE

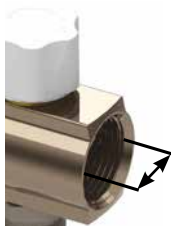

G 3/4
G 1"
G 1 1/4

INTERASSI



G 3/4 40 mm
G 1" 50 mm
G 1 1/4 50 mm



Tubo multistrato
W 24x19 - TP 97
G 3/4 EK - TP 98

REGOLATORI E MISURATORI DI PORTATA



I collettori di regolazione e bilanciamento, con regolatori e misuratori di portata TM 4012, danno la possibilità di una immediata verifica del bilanciamento dell'impianto attraverso la lettura della portata. La regolazione può essere bloccata tramite un coperchio d'arresto. Il bicchiere e la molla di misurazione possono essere smontati e puliti con l'impianto in funzione. Questo collettore deve essere installato sulla mandata.

DETENTORI



I collettori di regolazione e bilanciamento (tipo detentore) sono dotati di regolazione micrometrica e predisposti per la memoria di posizione nel caso di chiusura momentanea e possono essere montati indifferentemente sia sulle mandate sia sui ritorni dei circuiti.



VITONE TERMOSTATIZZABILE

L'organo di tenuta sullo stelo dei collettori con valvole incorporate predisposte per la regolazione elettrotermica è ispezionabile e sostituibile anche con impianto in funzione. L'asta di comando è in acciaio inossidabile AISI 316 con una tenuta garantita da due guarnizioni o-ring in EPDM perossidico.

Tutti i collettori serie CD vengono testati al 100% con prova di tenuta pneumatica a controllo elettronico.

Le caratteristiche del fluido dell'impianto devono essere conformi alla direttiva UNI 8065:2019.

COLLETTORI DI DISTRIBUZIONE PER RISCALDAMENTO CON REGOLATORI E MISURATORI DI PORTATA IN MANDATA

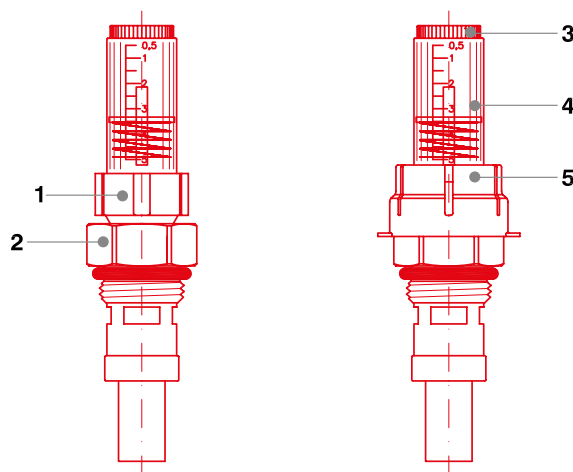

1. Ghiera di regolazione
2. Ghiera di fissaggio
3. Ghiera del bicchiere
4. Bicchiere
5. Coperchio d'arresto

ISTRUZIONI DI REGOLAZIONE COLLETTORI CON REGOLATORI MISURATORI DI PORTATA IN MANDATA

BILANCIAMENTO DEI CIRCUITI IDRAULICI

Il valore della portata teorica di un circuito idraulico, stabilito dal tecnico, è determinato dalla regolazione effettuata tramite i regolatori e misuratori di portata TM 4012 cod. 69000010 posizionati sulla mandata del circuito.

La regolazione deve avvenire con la valvola posta sul ritorno completamente aperta.

Dato che le portate di ciascun anello si influenzano tra loro, è importante che le regolazioni siano effettuate per ogni anello fino all'effettivo raggiungimento dei valori di portata in l/min stabiliti dal progetto.

PROTEZIONE DEL BILANCIAMENTO IDRAULICO CONTRO LE MANOMISSIONI

La regolazione dei regolatori misuratori di portata può essere bloccata tramite un coperchio d'arresto.

In caso di necessità, i coperchi possono essere piombati con filo di ferro e piombo.

PULIZIA

Il bicchiere e la molla di misurazione possono essere smontati per la manutenzione e puliti anche con l'impianto in funzione. Per effettuare l'operazione:

- chiudere il Top meter e il vitone posto sul collettore di ritorno
- svitare il bicchiere facendo forza sulla ghiera dello stesso e toglierlo. Attenzione a non perdere la molla di misurazione
- risulterà una leggera, ma trascurabile, perdita durante l'operazione
- il bicchiere ora può essere, se necessario, pulito senza difficoltà
- il rimontaggio si effettua invertendo le operazioni.

PERDITE DI CARICO

La perdita di carico totale per circuito di riscaldamento si compone di varie perdite di carico: valvola di ritorno, tubi e regolatore misuratore di portata.

COLLETTORI DI DISTRIBUZIONE PER RISCALDAMENTO CON DETENTORI INCORPORATI

ISTRUZIONI DI REGOLAZIONE DEI COLLETTORI CON DETENTORI

Svitare il tappo (1). Con la chiave a brugola avvitare l'otturatore fino a raggiungere la posizione di chiusura.

Dopo queste operazioni, il detentore è pronto per essere settato.

Sul diagramma di pressione differenziale è descritta la relazione tra valore di Kv, la posizione dell'otturatore e la corrispondente curva. Questo significa che, se si svita l'otturatore di un determinato numero di giri, si otterrà il Kv desiderato.

ESEMPIO

- Curva n. 1: 1/2 giri della vite - $K_v = 0,09$
- Curva n. 3: 1+1/2 giri della vite - $K_v = 0,76$

Utilizzando la ghiera (fornita a parte) cod. 3346656 è possibile creare un fine corsa meccanico all'otturatore.

Una volta impostata la portata desiderata tramite l'otturatore, la ghiera di regolazione deve essere avvitata in battuta contro l'otturatore.

Ora è possibile chiudere e riaprire l'otturatore senza perdere la posizione di regolazione impostata precedentemente.

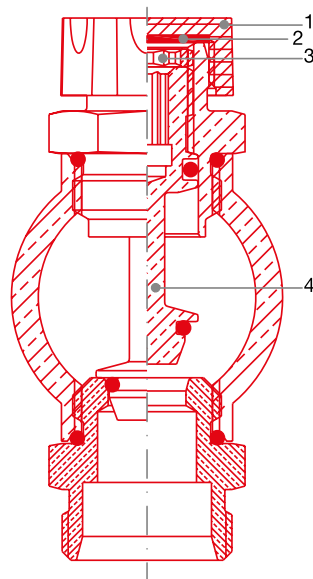

1. Tappo in ABS

2. Guarnizione di tenuta

3. Ghiera di regolazione cod. 3346656

4. Otturatore

10 + 10

In caso di perdite o trafiletti di acqua dall'asta del vitone termostattizzabile, si può agire serrando l'assemblato di tenuta fino alla cessazione della stessa. Se la perdita non dovesse terminare, si può sostituire il completo assemblato di tenuta del vitone con il gruppo in funzione eseguendo le operazioni sotto elencate.

- Togliere il cappuccio di protezione o il volantino manuale, o la testa termostatica o la testa termoelettrica;
- Svitare l'assemblato di tenuta con una chiave 9 mm bloccando il corpo vitone con una chiave da 19 mm;
- Sostituire l'assemblato di tenuta con l'accessorio di ricambio cod.: 67980200 avvitandolo con una chiave 9 mm;
- Riposizionare il cappuccio di protezione o il volantino manuale o la testa termostatica o la testa termoelettrica.

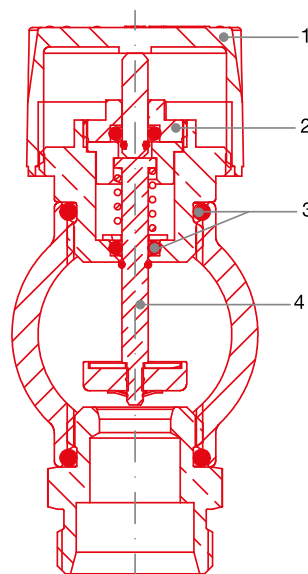

1. Tappo o volantino manuale in ABS

2. Assemblato di tenuta art.516

3. Guarnizione di tenuta

4. Otturatore

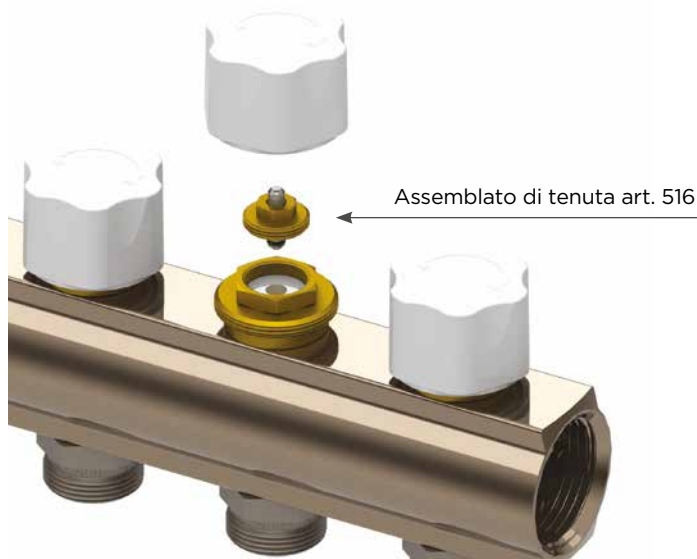

G 1"

SCHEMA PER SELEZIONARE LA CASSETTA CORRETTA

COLLETTORI DA G 1"

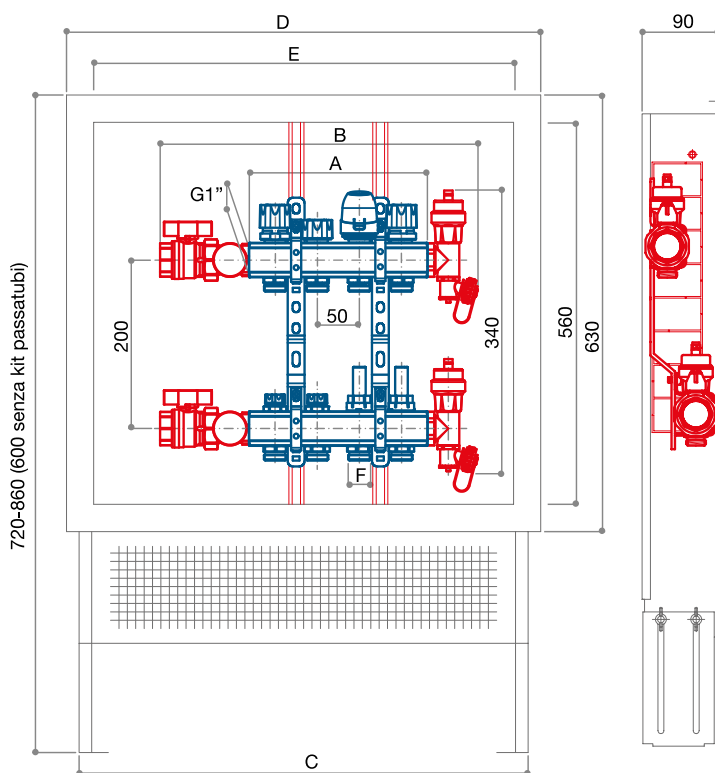

							CASSETTE	
VIE	A	B	C	D	E	F	ART.	COD.
2	112	276	500	560	490	W24x19 - G 3/4 EK	CF 490	68561405
3	162	326						
4	212	376						
5	262	426	700	760	690		CF 490	68561407
6	312	476						
7	362	526						
8	412	576	850	910	840		CF 490	68561408
9	462	626						
10	512	676						
11	562	726	1000	1060	990		CF 490	68561410
12	612	776						
13	662	826						

COLLETTORI DA G 1" CON SPURGO

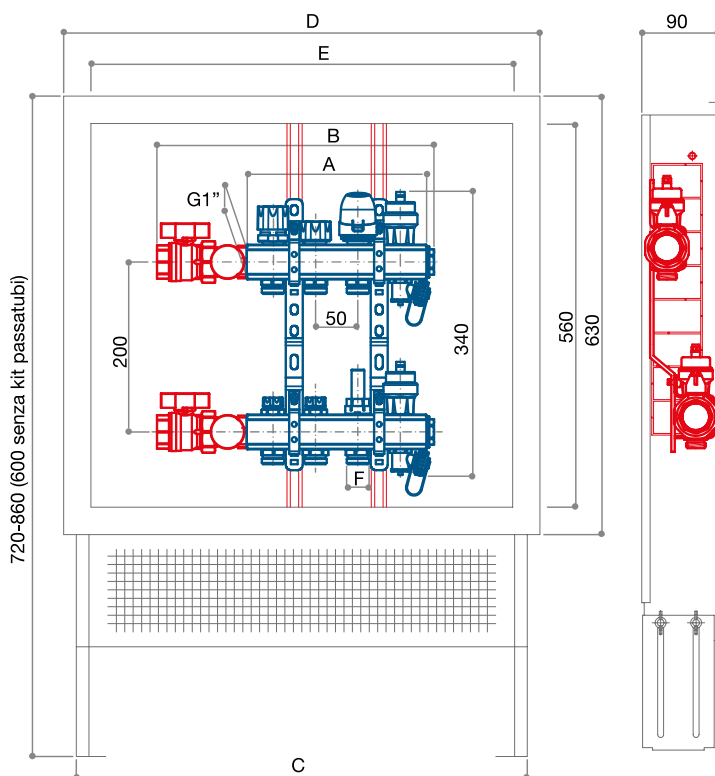

							CASSETTE	
VIE	A	B	C	D	E	F	ART.	COD.
2	162	276	500	560	490	W24x19 - G 3/4 EK	CF 490	68561405
3	212	326						
4	262	376						
5	312	426	700	760	690		CF 490	68561407
6	362	476						
7	412	526						
8	462	576	850	910	840		CF 490	68561408
9	512	626						
10	562	676						
11	612	726	662	776				
12	662	776						

G 1"1/4

SCHEMA PER SELEZIONARE LA CASSETTA CORRETTA

COLLETTORI DA G 1"1/4

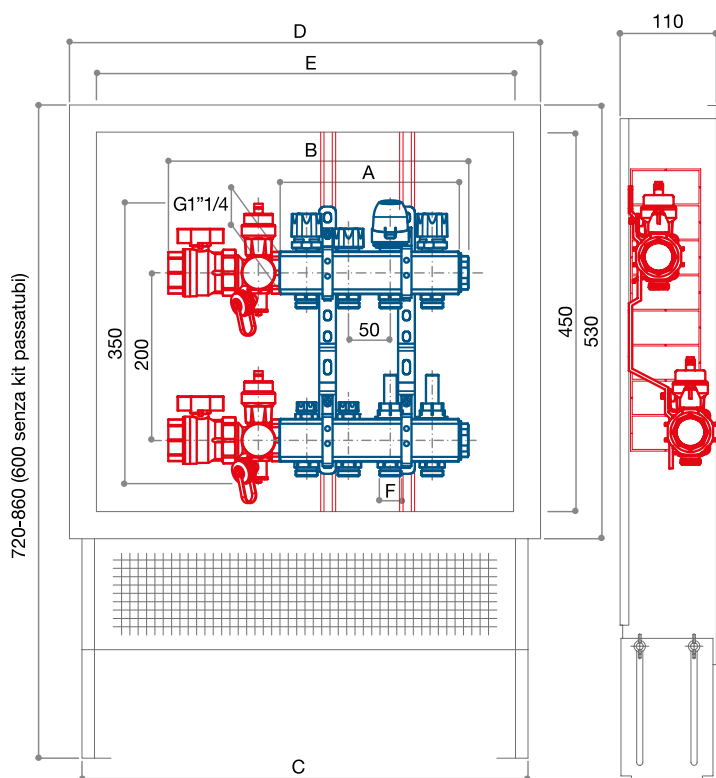

							CASSETTE	
VIE	A	B	C	D	E	F	ART.	COD.
2	114	260	500	565	490	W24x19 - G 3/4 EK	CF 485	68560705
3	164	310						
4	214	360						
5	264	410						
6	314	460						
7	364	510	700	765	690	CF 485	68560707	
8	414	560						
9	464	610						
10	514	660	850	915	840	CF 485	68560708	
11	564	710						
12	614	760						
13	664	810	1000	1065	990	CF 485	68560710	

COLLETTORI DA G 1"1/4 CON SPURGO

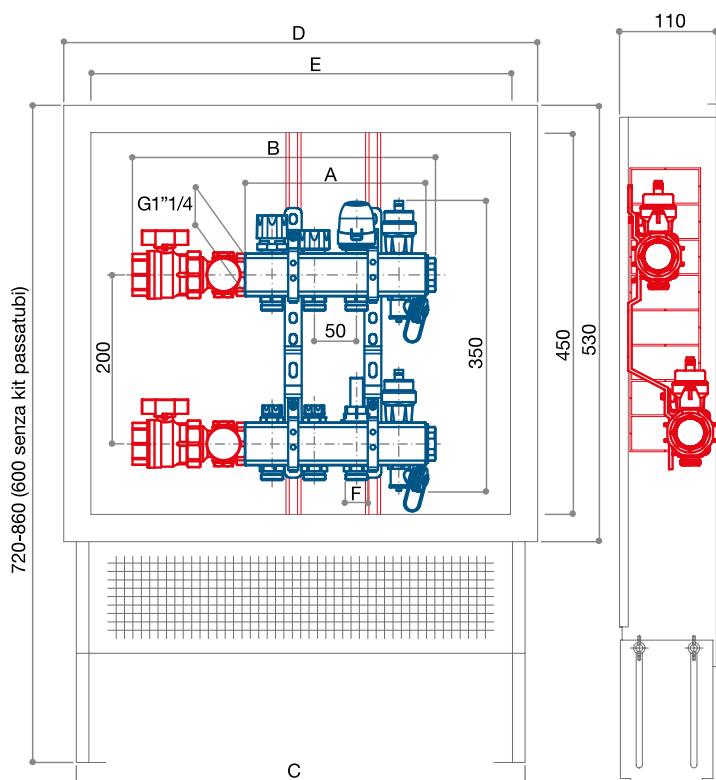



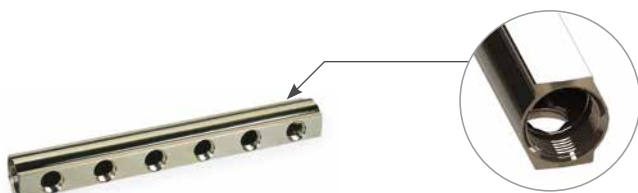

							CASSETTE	
VIE	A	B	C	D	E	F	ART.	COD.
2	164	310	500	565	490	W24x19 - G 3/4 EK	CF 485	68560705
3	214	360						
4	264	410						
5	314	460	700	765	690	CF 485	68560707	
6	364	510						
7	414	560						
8	464	610						
9	514	660	850	915	840	CF 485	68560708	
10	564	710						
11	614	760						
12	664	810	1000	1065	990	CF 485	68560710	

COLLETTORI DI DISTRIBUZIONE PER IMPIANTI DI RISCALDAMENTO



Collettore di distribuzione.

**CD 451**Interasse
40 mm

finitura gialla	finitura nichelata	MISURA	N. VIE						
COD.	COD.								
17012102	17012102N	G 3/4 x G 1/2	2	-	-	-	0,298	-	60
17012103	17012103N		3	-	-	-	0,448	-	40
17012104	17012104N		4	-	-	-	0,596	-	30
17012105	17012105N		5	-	-	-	0,746	-	25
17012106	17012106N		6	-	-	-	0,894	-	25
17012107	17012107N		7	-	-	-	1,044	-	20
17012108	17012108N		8	-	-	-	1,192	-	20
17012109	17012109N		9	-	-	-	1,342	-	20
17012110	17012110N		10	-	-	-	1,490	-	15

CD 456Interasse
50 mm

finitura gialla	finitura nichelata	MISURA	N. VIE						
COD.	COD.								
15012102	15012102N	G 1" x G 1/2	2	-	-	-	0,420	-	50
15012103	15012103N		3	-	-	-	0,630	-	35
15012104	15012104N		4	-	-	-	0,840	-	24
15012105	15012105N		5	-	-	-	1,050	-	20
15012106	15012106N		6	-	-	-	1,260	-	18
15012107	15012107N		7	-	-	-	1,470	-	15
15012108	15012108N		8	-	-	-	1,680	-	15
15012109	15012109N		9	-	-	-	1,890	-	15
15012110	15012110N		10	-	-	-	2,100	-	15
15012111	15012111N		11	-	-	-	2,310	-	10
15012112	15012112N		12	-	-	-	2,520	-	10

CD 860Interasse
50 mm

finitura gialla	finitura nichelata	MISURA	N. VIE						
COD.	COD.								
16012102	16012102N	G 1 1/4 x G 1/2	2	-	-	-	0,590	-	30
16012103	16012103N		3	-	-	-	0,866	-	20
16012104	16012104N		4	-	-	-	1,140	-	15
16012105	16012105N		5	-	-	-	1,416	-	12
16012106	16012106N		6	-	-	-	1,690	-	10
16012107	16012107N		7	-	-	-	1,966	-	10
16012108	16012108N		8	-	-	-	2,240	-	10
16012109	16012109N		9	-	-	-	2,516	-	10
16012110	16012110N		10	-	-	-	2,790	-	10
16012111	16012111N		11	-	-	-	3,066	-	5
16012112	16012112N		12	-	-	-	3,340	-	5

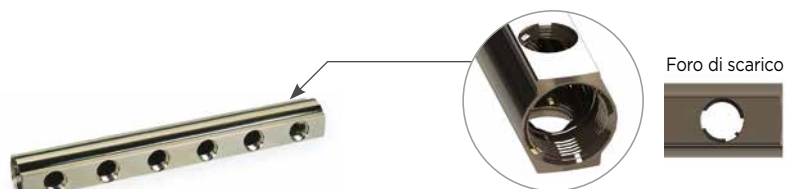

Collettore di distribuzione con foro di scarico da 1/2.

**CD 457**

finitura gialla		finitura nichelata		MISURA	N. VIE						
COD.	COD.	COD.	COD.								
15022102	15022102N	G 1" x G 1/2			2	-	-	-	0,420	-	50
15022103	15022103N				3	-	-	-	0,630	-	35
15022104	15022104N				4	-	-	-	0,840	-	24
15022105	15022105N				5	-	-	-	1,050	-	20
15022106	15022106N				6	-	-	-	1,260	-	18
15022107	15022107N				7	-	-	-	1,470	-	15
15022108	15022108N				8	-	-	-	1,700	-	15
15022109	15022109N				9	-	-	-	1,900	-	15
15022110	15022110N				10	-	-	-	2,110	-	15
15022111	15022111N				11	-	-	-	2,320	-	10
15022112	15022112N				12	-	-	-	2,510	-	10





CD 861

finitura gialla		finitura nichelata		MISURA	N. VIE						
COD.	COD.	COD.	COD.								
16022102	16022102N	G 1" ¹ / ₄ x G 1/2			2	-	-	-	0,570	-	30
16022103	16022103N				3	-	-	-	0,860	-	20
16022104	16022104N				4	-	-	-	1,130	-	15
16022105	16022105N				5	-	-	-	1,390	-	12
16022106	16022106N				6	-	-	-	1,680	-	10
16022107	16022107N				7	-	-	-	1,940	-	10
16022108	16022108N				8	-	-	-	2,210	-	10
16022109	16022109N				9	-	-	-	2,470	-	10
16022110	16022110N				10	-	-	-	2,760	-	10
16022111	16022111N				11	-	-	-	3,040	-	5
16022112	16022112N				12	-	-	-	3,290	-	5



Collettore di distribuzione con raccordi premontati articolo RD 900.





**CD 459**

finitura gialla	finitura nichelata	MISURA	N. VIE						
COD.	COD.								
15032402	15032402N	G 1" x (W24x19)	2	TR 91	TP 95	TP 97	0,496	-	30
15032403	15032403N		3	TR 91	TP 95	TP 97	0,744	-	20
15032404	15032404N		4	TR 91	TP 95	TP 97	0,992	-	15
15032405	15032405N		5	TR 91	TP 95	TP 97	1,240	-	12
15032406	15032406N		6	TR 91	TP 95	TP 97	1,488	-	12
15032407	15032407N		7	TR 91	TP 95	TP 97	1,736	-	10
15032408	15032408N		8	TR 91	TP 95	TP 97	1,984	-	12
15032409	15032409N		9	TR 91	TP 95	TP 97	2,232	-	10
15032410	15032410N		10	TR 91	TP 95	TP 97	2,480	-	10
15032411	15032411N		11	TR 91	TP 95	TP 97	2,728	-	10
15032412	15032412N		12	TR 91	TP 95	TP 97	2,976	-	10

CD 461

finitura gialla	finitura nichelata	MISURA	N. VIE						
COD.	COD.								
15032702	15032702N	G 1" x G 3/4 EK	2	TR 91/A	TP 98	TP 99	0,520	-	30
15032703	15032703N		3	TR 91/A	TP 98	TP 99	0,780	-	20
15032704	15032704N		4	TR 91/A	TP 98	TP 99	1,040	-	15
15032705	15032705N		5	TR 91/A	TP 98	TP 99	1,300	-	12
15032706	15032706N		6	TR 91/A	TP 98	TP 99	1,560	-	12
15032707	15032707N		7	TR 91/A	TP 98	TP 99	1,820	-	10
15032708	15032708N		8	TR 91/A	TP 98	TP 99	2,080	-	12
15032709	15032709N		9	TR 91/A	TP 98	TP 99	2,340	-	10
15032710	15032710N		10	TR 91/A	TP 98	TP 99	2,600	-	10
15032711	15032711N		11	TR 91/A	TP 98	TP 99	2,860	-	10
15032712	15032712N		12	TR 91/A	TP 98	TP 99	3,120	-	10

CD 862

finitura gialla	finitura nichelata	MISURA	N. VIE						
COD.	COD.								
16032402	16032402N	G 1 1/4 x (W24x19)	2	TR 91	TP 95	TP 97	0,666	-	20
16032403	16032403N		3	TR 91	TP 95	TP 97	0,980	-	12
16032404	16032404N		4	TR 91	TP 95	TP 97	1,292	-	10
16032405	16032405N		5	TR 91	TP 95	TP 97	1,606	-	10
16032406	16032406N		6	TR 91	TP 95	TP 97	1,918	-	10
16032407	16032407N		7	TR 91	TP 95	TP 97	2,232	-	10
16032408	16032408N		8	TR 91	TP 95	TP 97	2,544	-	8
16032409	16032409N		9	TR 91	TP 95	TP 97	2,858	-	8
16032410	16032410N		10	TR 91	TP 95	TP 97	3,170	-	8
16032411	16032411N		11	TR 91	TP 95	TP 97	3,484	-	8
16032412	16032412N		12	TR 91	TP 95	TP 97	3,796	-	8

CD 864

finitura gialla	finitura nichelata	MISURA	N. VIE						
COD.	COD.								
16032702	16032702N	G 1 1/4 x G 3/4 EK	2	TR 91/A	TP 98	TP 99	0,690	-	20
16032703	16032703N		3	TR 91/A	TP 98	TP 99	1,019	-	12
16032704	16032704N		4	TR 91/A	TP 98	TP 99	1,340	-	10
16032705	16032705N		5	TR 91/A	TP 98	TP 99	1,666	-	10
16032706	16032706N		6	TR 91/A	TP 98	TP 99	1,990	-	10
16032707	16032707N		7	TR 91/A	TP 98	TP 99	2,316	-	10
16032708	16032708N		8	TR 91/A	TP 98	TP 99	2,640	-	8
16032709	16032709N		9	TR 91/A	TP 98	TP 99	2,966	-	8
16032710	16032710N		10	TR 91/A	TP 98	TP 99	3,290	-	8
16032711	16032711N		11	TR 91/A	TP 98	TP 99	3,616	-	8
16032712	16032712N		12	TR 91/A	TP 98	TP 99	3,940	-	8

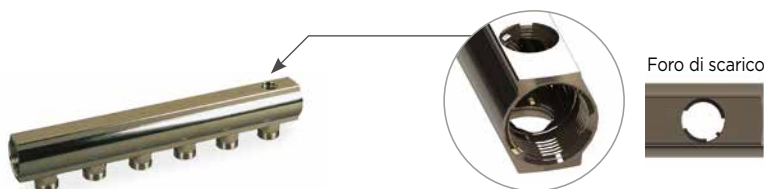

Foro di scarico

Collettore di distribuzione con foro di scarico da 1/2 e raccordi premontati articolo RD 900.



CD 460

finitura gialla		finitura nichelata		MISURA	N. VIE	TR 91	TP 95	TP 97	RD 900	RD 900	RD 900
COD.	COD.	COD.	COD.								
15042402	15042402N	15042403	15042403N	G 1" x (W24x19)	2	TR 91	TP 95	TP 97	0,486	-	30
15042403	15042403N	15042404	15042404N		3	TR 91	TP 95	TP 97	0,734	-	20
15042404	15042404N	15042405	15042405N		4	TR 91	TP 95	TP 97	0,982	-	15
15042405	15042405N	15042406	15042406N		5	TR 91	TP 95	TP 97	1,230	-	12
15042406	15042406N	15042407	15042407N		6	TR 91	TP 95	TP 97	1,478	-	12
15042407	15042407N	15042408	15042408N		7	TR 91	TP 95	TP 97	1,726	-	10
15042408	15042408N	15042409	15042409N		8	TR 91	TP 95	TP 97	1,974	-	12
15042409	15042409N	15042410	15042410N		9	TR 91	TP 95	TP 97	2,222	-	10
15042410	15042410N	15042411	15042411N		10	TR 91	TP 95	TP 97	2,470	-	10
15042411	15042411N	15042412	15042412N		11	TR 91	TP 95	TP 97	2,718	-	10
15042412	15042412N				12	TR 91	TP 95	TP 97	2,966	-	10

CD 462

finitura gialla		finitura nichelata		MISURA	N. VIE	TR 91/A	TP 98	TP 99	RD 900	RD 900	RD 900
COD.	COD.	COD.	COD.								
15042702	15042702N	15042703	15042703N	G 1" x G 3/4 EK	2	TR 91/A	TP 98	TP 99	0,510	-	30
15042703	15042703N	15042704	15042704N		3	TR 91/A	TP 98	TP 99	0,770	-	20
15042704	15042704N	15042705	15042705N		4	TR 91/A	TP 98	TP 99	1,030	-	15
15042705	15042705N	15042706	15042706N		5	TR 91/A	TP 98	TP 99	1,290	-	12
15042706	15042706N	15042707	15042707N		6	TR 91/A	TP 98	TP 99	1,550	-	12
15042707	15042707N	15042708	15042708N		7	TR 91/A	TP 98	TP 99	1,810	-	10
15042708	15042708N	15042709	15042709N		8	TR 91/A	TP 98	TP 99	2,070	-	12
15042709	15042709N	15042710	15042710N		9	TR 91/A	TP 98	TP 99	2,330	-	10
15042710	15042710N	15042711	15042711N		10	TR 91/A	TP 98	TP 99	2,590	-	10
15042711	15042711N	15042712	15042712N		11	TR 91/A	TP 98	TP 99	2,850	-	10
15042712	15042712N				12	TR 91/A	TP 98	TP 99	3,110	-	10

CD 863

finitura gialla		finitura nichelata		MISURA	N. VIE	TR 91	TP 95	TP 97	RD 900	RD 900	RD 900
COD.	COD.	COD.	COD.								
16042402	16042402N	16042403	16042403N	G 1"1/4 x (W24x19)	2	TR 91	TP 95	TP 97	0,656	-	20
16042403	16042403N	16042404	16042404N		3	TR 91	TP 95	TP 97	0,970	-	12
16042404	16042404N	16042405	16042405N		4	TR 91	TP 95	TP 97	1,282	-	10
16042405	16042405N	16042406	16042406N		5	TR 91	TP 95	TP 97	1,596	-	10
16042406	16042406N	16042407	16042407N		6	TR 91	TP 95	TP 97	1,908	-	10
16042407	16042407N	16042408	16042408N		7	TR 91	TP 95	TP 97	2,222	-	10
16042408	16042408N	16042409	16042409N		8	TR 91	TP 95	TP 97	2,534	-	8
16042409	16042409N	16042410	16042410N		9	TR 91	TP 95	TP 97	2,848	-	8
16042410	16042410N	16042411	16042411N		10	TR 91	TP 95	TP 97	3,160	-	8
16042411	16042411N	16042412	16042412N		11	TR 91	TP 95	TP 97	3,474	-	8
16042412	16042412N				12	TR 91	TP 95	TP 97	3,786	-	8





CD 865

finitura gialla		finitura nichelata		MISURA	N. VIE	TR 91/A	TP 98	TP 99	RD 900	RD 900	RD 900
COD.	COD.	COD.	COD.								
16042702	16042702N	16042703	16042703N	G 1"1/4 x G 3/4 EK	2	TR 91/A	TP 98	TP 99	0,680	-	20
16042703	16042703N	16042704	16042704N		3	TR 91/A	TP 98	TP 99	1,009	-	12
16042704	16042704N	16042705	16042705N		4	TR 91/A	TP 98	TP 99	1,330	-	10
16042705	16042705N	16042706	16042706N		5	TR 91/A	TP 98	TP 99	1,656	-	10
16042706	16042706N	16042707	16042707N		6	TR 91/A	TP 98	TP 99	1,980	-	10
16042707	16042707N	16042708	16042708N		7	TR 91/A	TP 98	TP 99	2,306	-	10
16042708	16042708N	16042709	16042709N		8	TR 91/A	TP 98	TP 99	2,630	-	8
16042709	16042709N	16042710	16042710N		9	TR 91/A	TP 98	TP 99	2,956	-	8
16042710	16042710N	16042711	16042711N		10	TR 91/A	TP 98	TP 99	3,280	-	8
16042711	16042711N	16042712	16042712N		11	TR 91/A	TP 98	TP 99	3,606	-	8
16042712	16042712N				12	TR 91/A	TP 98	TP 99	3,930	-	8



Collettore di distribuzione premontato con valvole incorporate predisposte per la regolazione elettrotermica e con cappucci di protezione.

CD 1466

finitura gialla	finitura nichelata	MISURA	N. VIE						
COD.	COD.								
15112402	15112402N	G 1" x (W24x19)	2	TR 91	TP 95	TP 97	0,644	-	20
15112403	15112403N		3	TR 91	TP 95	TP 97	0,956	-	15
15112404	15112404N		4	TR 91	TP 95	TP 97	1,268	-	12
15112405	15112405N		5	TR 91	TP 95	TP 97	1,580	-	10
15112406	15112406N		6	TR 91	TP 95	TP 97	1,892	-	9
15112407	15112407N		7	TR 91	TP 95	TP 97	2,204	-	8
15112408	15112408N		8	TR 91	TP 95	TP 97	2,516	-	8
15112409	15112409N		9	TR 91	TP 95	TP 97	2,828	-	8
15112410	15112410N		10	TR 91	TP 95	TP 97	3,140	-	8
15112411	15112411N		11	TR 91	TP 95	TP 97	3,452	-	8
15112412	15112412N		12	TR 91	TP 95	TP 97	3,764	-	8

CD 1446

finitura gialla	finitura nichelata	MISURA	N. VIE						
COD.	COD.								
15112702	15112702N	G 1" x G 3/4 EK	2	TR 91/A	TP 98	TP 99	0,664	-	20
15112703	15112703N		3	TR 91/A	TP 98	TP 99	0,986	-	15
15112704	15112704N		4	TR 91/A	TP 98	TP 99	1,308	-	12
15112705	15112705N		5	TR 91/A	TP 98	TP 99	1,630	-	10
15112706	15112706N		6	TR 91/A	TP 98	TP 99	1,952	-	9
15112707	15112707N		7	TR 91/A	TP 98	TP 99	2,274	-	8
15112708	15112708N		8	TR 91/A	TP 98	TP 99	2,596	-	8
15112709	15112709N		9	TR 91/A	TP 98	TP 99	2,918	-	8
15112710	15112710N		10	TR 91/A	TP 98	TP 99	3,240	-	8
15112711	15112711N		11	TR 91/A	TP 98	TP 99	3,562	-	8
15112712	15112712N		12	TR 91/A	TP 98	TP 99	3,884	-	8

CD 875

finitura gialla	finitura nichelata	MISURA	N. VIE						
COD.	COD.								
16112402	16112402N	G 1"1/4 x (W24x19)	2	TR 91	TP 95	TP 97	0,794	-	15
16112403	16112403N		3	TR 91	TP 95	TP 97	1,166	-	12
16112404	16112404N		4	TR 91	TP 95	TP 97	1,538	-	10
16112405	16112405N		5	TR 91	TP 95	TP 97	1,960	-	8
16112406	16112406N		6	TR 91	TP 95	TP 97	2,282	-	8
16112407	16112407N		7	TR 91	TP 95	TP 97	2,654	-	8
16112408	16112408N		8	TR 91	TP 95	TP 97	3,026	-	6
16112409	16112409N		9	TR 91	TP 95	TP 97	3,398	-	6
16112410	16112410N		10	TR 91	TP 95	TP 97	3,770	-	6
16112411	16112411N		11	TR 91	TP 95	TP 97	4,142	-	6
16112412	16112412N		12	TR 91	TP 95	TP 97	4,514	-	6

CD 876

finitura gialla	finitura nichelata	MISURA	N. VIE						
COD.	COD.								
16112702	16112702N	G 1"1/4 x G 3/4 EK	2	TR 91/A	TP 98	TP 99	0,814	-	15
16112703	16112703N		3	TR 91/A	TP 98	TP 99	1,196	-	12
16112704	16112704N		4	TR 91/A	TP 98	TP 99	1,578	-	10
16112705	16112705N		5	TR 91/A	TP 98	TP 99	1,960	-	8
16112706	16112706N		6	TR 91/A	TP 98	TP 99	2,342	-	8
16112707	16112707N		7	TR 91/A	TP 98	TP 99	2,724	-	8
16112708	16112708N		8	TR 91/A	TP 98	TP 99	3,106	-	6
16112709	16112709N		9	TR 91/A	TP 98	TP 99	3,488	-	6
16112710	16112710N		10	TR 91/A	TP 98	TP 99	3,870	-	6
16112711	16112711N		11	TR 91/A	TP 98	TP 99	4,252	-	6
16112712	16112712N		12	TR 91/A	TP 98	TP 99	4,634	-	6



Raccordi per tubo rame



Raccordi per tubo plastica



Raccordi per tubo multistrato



Raccordi: capitolo 7





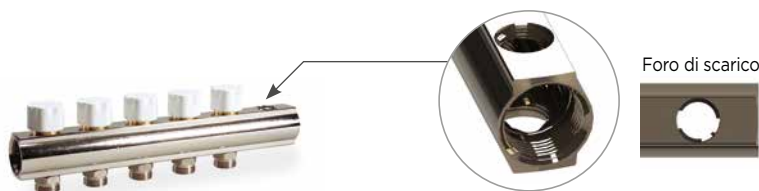

Accessori: capitolo 2.A



Foro di scarico

Collettore di distribuzione con 2 fori di scarico da 1/2 premontato con valvole incorporate predisposte per la regolazione elettrotermica e con cappucci di protezione.

CD 3466

finitura gialla	finitura nichelata	MISURA	N. VIE						
COD.	COD.								
15122402	15122402N	G 1" x (W24x19)	2	TR 91	TP 95	TP 97	0,834	-	15
15122403	15122403N		3	TR 91	TP 95	TP 97	1,146	-	12
15122404	15122404N		4	TR 91	TP 95	TP 97	1,458	-	10
15122405	15122405N		5	TR 91	TP 95	TP 97	1,770	-	9
15122406	15122406N		6	TR 91	TP 95	TP 97	2,082	-	8
15122407	15122407N		7	TR 91	TP 95	TP 97	2,394	-	8
15122408	15122408N		8	TR 91	TP 95	TP 97	2,706	-	8
15122409	15122409N		9	TR 91	TP 95	TP 97	3,018	-	8
15122410	15122410N		10	TR 91	TP 95	TP 97	3,330	-	8
15122411	15122411N		11	TR 91	TP 95	TP 97	3,642	-	8
15122412	15122412N		12	TR 91	TP 95	TP 97	3,954	-	8

CD 3446

finitura gialla	finitura nichelata	MISURA	N. VIE						
COD.	COD.								
15122702	15122702N	G 1" x G 3/4 EK	2	TR 91/A	TP 98	TP 99	0,854	-	15
15122703	15122703N		3	TR 91/A	TP 98	TP 99	1,176	-	12
15122704	15122704N		4	TR 91/A	TP 98	TP 99	1,498	-	10
15122705	15122705N		5	TR 91/A	TP 98	TP 99	1,820	-	9
15122706	15122706N		6	TR 91/A	TP 98	TP 99	2,142	-	8
15122707	15122707N		7	TR 91/A	TP 98	TP 99	2,464	-	8
15122708	15122708N		8	TR 91/A	TP 98	TP 99	2,786	-	8
15122709	15122709N		9	TR 91/A	TP 98	TP 99	3,108	-	8
15122710	15122710N		10	TR 91/A	TP 98	TP 99	3,430	-	8
15122711	15122711N		11	TR 91/A	TP 98	TP 99	3,752	-	8
15122712	15122712N		12	TR 91/A	TP 98	TP 99	4,074	-	8

CD 877

finitura gialla	finitura nichelata	MISURA	N. VIE						
COD.	COD.								
16122402	16122402N	G 1 1/4 x (W24x19)	2	TR 91	TP 95	TP 97	1,044	-	12
16122403	16122403N		3	TR 91	TP 95	TP 97	1,416	-	10
16122404	16122404N		4	TR 91	TP 95	TP 97	1,788	-	8
16122405	16122405N		5	TR 91	TP 95	TP 97	2,160	-	8
16122406	16122406N		6	TR 91	TP 95	TP 97	2,532	-	6
16122407	16122407N		7	TR 91	TP 95	TP 97	2,904	-	6
16122408	16122408N		8	TR 91	TP 95	TP 97	3,276	-	6
16122409	16122409N		9	TR 91	TP 95	TP 97	3,648	-	6
16122410	16122410N		10	TR 91	TP 95	TP 97	4,020	-	6
16122411	16122411N		11	TR 91	TP 95	TP 97	4,392	-	6
16122412	16122412N		12	TR 91	TP 95	TP 97	4,764	-	6

CD 878







finitura gialla	finitura nichelata	MISURA	N. VIE						
COD.	COD.								
16122702	16122702N	G 1 1/4 x G 3/4 EK	2	TR 91/A	TP 98	TP 99	1,064	-	12
16122703	16122703N		3	TR 91/A	TP 98	TP 99	1,446	-	10
16122704	16122704N		4	TR 91/A	TP 98	TP 99	1,828	-	8
16122705	16122705N		5	TR 91/A	TP 98	TP 99	2,210	-	8
16122706	16122706N		6	TR 91/A	TP 98	TP 99	2,592	-	6
16122707	16122707N		7	TR 91/A	TP 98	TP 99	2,974	-	6
16122708	16122708N		8	TR 91/A	TP 98	TP 99	3,356	-	6
16122709	16122709N		9	TR 91/A	TP 98	TP 99	3,738	-	6
16122710	16122710N		10	TR 91/A	TP 98	TP 99	4,120	-	6
16122711	16122711N		11	TR 91/A	TP 98	TP 99	4,502	-	6
16122712	16122712N		12	TR 91/A	TP 98	TP 99	4,884	-	6







Collettore di distribuzione premontato con valvole incorporate predisposte per la regolazione elettrotermica e con volantino di comando manuale.







CD 466

finitura gialla	finitura nichelata	MISURA	N. VIE						
COD.	COD.								
15152402	15152402N	G 1" x (W24x19)	2	TR 91	TP 95	TP 97	0,664	-	10
15152403	15152403N		3	TR 91	TP 95	TP 97	0,986	-	10
15152404	15152404N		4	TR 91	TP 95	TP 97	1,308	-	8
15152405	15152405N		5	TR 91	TP 95	TP 97	1,630	-	8
15152406	15152406N		6	TR 91	TP 95	TP 97	1,952	-	6
15152407	15152407N		7	TR 91	TP 95	TP 97	2,274	-	6
15152408	15152408N		8	TR 91	TP 95	TP 97	2,596	-	6
15152409	15152409N		9	TR 91	TP 95	TP 97	2,918	-	6
15152410	15152410N		10	TR 91	TP 95	TP 97	3,240	-	6
15152411	15152411N		11	TR 91	TP 95	TP 97	3,562	-	6
15152412	15152412N		12	TR 91	TP 95	TP 97	3,884	-	6

CD 446

finitura gialla	finitura nichelata	MISURA	N. VIE						
COD.	COD.								
15152702	15152702N	G 1" x G 3/4 EK	2	TR 91/A	TP 98	TP 99	0,684	-	10
15152703	15152703N		3	TR 91/A	TP 98	TP 99	1,016	-	10
15152704	15152704N		4	TR 91/A	TP 98	TP 99	1,348	-	8
15152705	15152705N		5	TR 91/A	TP 98	TP 99	1,680	-	8
15152706	15152706N		6	TR 91/A	TP 98	TP 99	2,012	-	6
15152707	15152707N		7	TR 91/A	TP 98	TP 99	2,344	-	6
15152708	15152708N		8	TR 91/A	TP 98	TP 99	2,676	-	6
15152709	15152709N		9	TR 91/A	TP 98	TP 99	3,008	-	6
15152710	15152710N		10	TR 91/A	TP 98	TP 99	3,340	-	6
15152711	15152711N		11	TR 91/A	TP 98	TP 99	3,672	-	6
15152712	15152712N		12	TR 91/A	TP 98	TP 99	4,004	-	6

CD 871

finitura gialla	finitura nichelata	MISURA	N. VIE						
COD.	COD.								
16152402	16152402N	G 1 1/4 x (W24x19)	2	TR 91	TP 95	TP 97	0,814	-	8
16152403	16152403N		3	TR 91	TP 95	TP 97	1,196	-	8
16152404	16152404N		4	TR 91	TP 95	TP 97	1,578	-	6
16152405	16152405N		5	TR 91	TP 95	TP 97	1,960	-	6
16152406	16152406N		6	TR 91	TP 95	TP 97	2,342	-	4
16152407	16152407N		7	TR 91	TP 95	TP 97	2,724	-	4
16152408	16152408N		8	TR 91	TP 95	TP 97	3,106	-	4
16152409	16152409N		9	TR 91	TP 95	TP 97	3,488	-	4
16152410	16152410N		10	TR 91	TP 95	TP 97	3,870	-	4
16152411	16152411N		11	TR 91	TP 95	TP 97	4,252	-	4
16152412	16152412N		12	TR 91	TP 95	TP 97	4,634	-	4

CD 872



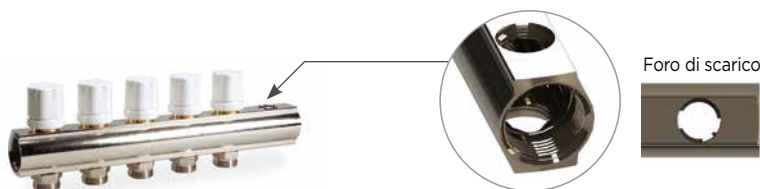

finitura gialla	finitura nichelata	MISURA	N. VIE						
COD.	COD.								
16152702	16152702N	G 1 1/4 x G 3/4 EK	2	TR 91/A	TP 98	TP 99	0,834	-	8
16152703	16152703N		3	TR 91/A	TP 98	TP 99	1,226	-	8
16152704	16152704N		4	TR 91/A	TP 98	TP 99	1,618	-	6
16152705	16152705N		5	TR 91/A	TP 98	TP 99	2,010	-	6
16152706	16152706N		6	TR 91/A	TP 98	TP 99	2,402	-	4
16152707	16152707N		7	TR 91/A	TP 98	TP 99	2,794	-	4
16152708	16152708N		8	TR 91/A	TP 98	TP 99	3,186	-	4
16152709	16152709N		9	TR 91/A	TP 98	TP 99	3,578	-	4
16152710	16152710N		10	TR 91/A	TP 98	TP 99	3,970	-	4
16152711	16152711N		11	TR 91/A	TP 98	TP 99	4,362	-	4
16152712	16152712N		12	TR 91/A	TP 98	TP 99	4,754	-	4





Collettore di distribuzione con 2 fori di scarico da 1/2 premontato con valvole incorporate predisposte per la regolazione elettrotermica e con volantino di comando manuale.

CD 2466

finitura gialla	finitura nichelata	MISURA	N. VIE						
COD.	COD.								
15162402	15162402N	G 1" x (W24x19)	2	TR 91	TP 95	TP 97	0,854	-	10
15162403	15162403N		3	TR 91	TP 95	TP 97	1,176	-	8
15162404	15162404N		4	TR 91	TP 95	TP 97	1,498	-	8
15162405	15162405N		5	TR 91	TP 95	TP 97	1,820	-	6
15162406	15162406N		6	TR 91	TP 95	TP 97	2,142	-	6
15162407	15162407N		7	TR 91	TP 95	TP 97	2,464	-	6
15162408	15162408N		8	TR 91	TP 95	TP 97	2,785	-	6
15162409	15162409N		9	TR 91	TP 95	TP 97	3,108	-	6
15162410	15162410N		10	TR 91	TP 95	TP 97	3,430	-	6
15162411	15162411N		11	TR 91	TP 95	TP 97	3,752	-	6
15162412	15162412N		12	TR 91	TP 95	TP 97	4,074	-	6

CD 2446

finitura gialla	finitura nichelata	MISURA	N. VIE						
COD.	COD.								
15162702	15162702N	G 1" x G 3/4 EK	2	TR 91/A	TP 98	TP 99	0,874	-	10
15162703	15162703N		3	TR 91/A	TP 98	TP 99	1,206	-	8
15162704	15162704N		4	TR 91/A	TP 98	TP 99	1,538	-	8
15162705	15162705N		5	TR 91/A	TP 98	TP 99	1,870	-	6
15162706	15162706N		6	TR 91/A	TP 98	TP 99	2,202	-	6
15162707	15162707N		7	TR 91/A	TP 98	TP 99	2,534	-	6
15162708	15162708N		8	TR 91/A	TP 98	TP 99	2,866	-	6
15162709	15162709N		9	TR 91/A	TP 98	TP 99	3,198	-	6
15162710	15162710N		10	TR 91/A	TP 98	TP 99	3,530	-	6
15162711	15162711N		11	TR 91/A	TP 98	TP 99	3,862	-	6
15162712	15162712N		12	TR 91/A	TP 98	TP 99	4,194	-	6

CD 873

finitura gialla	finitura nichelata	MISURA	N. VIE						
COD.	COD.								
16162402	16162402N	G 1 1/4 x (W24x19)	2	TR 91	TP 95	TP 97	1,064	-	8
16162403	16162403N		3	TR 91	TP 95	TP 97	1,446	-	6
16162404	16162404N		4	TR 91	TP 95	TP 97	1,828	-	6
16162405	16162405N		5	TR 91	TP 95	TP 97	2,210	-	6
16162406	16162406N		6	TR 91	TP 95	TP 97	2,592	-	6
16162407	16162407N		7	TR 91	TP 95	TP 97	2,974	-	6
16162408	16162408N		8	TR 91	TP 95	TP 97	3,356	-	6
16162409	16162409N		9	TR 91	TP 95	TP 97	3,738	-	6
16162410	16162410N		10	TR 91	TP 95	TP 97	4,120	-	6
16162411	16162411N		11	TR 91	TP 95	TP 97	4,502	-	6
16162412	16162412N		12	TR 91	TP 95	TP 97	4,884	-	6

CD 874







finitura gialla	finitura nichelata	MISURA	N. VIE						
COD.	COD.								
16162702	16162702N	G 1 1/4 x G 3/4 EK	2	TR 91/A	TP 98	TP 99	1,084	-	8
16162703	16162703N		3	TR 91/A	TP 98	TP 99	1,476	-	6
16162704	16162704N		4	TR 91/A	TP 98	TP 99	1,868	-	6
16162705	16162705N		5	TR 91/A	TP 98	TP 99	2,260	-	6
16162706	16162706N		6	TR 91/A	TP 98	TP 99	2,652	-	6
16162707	16162707N		7	TR 91/A	TP 98	TP 99	3,044	-	6
16162708	16162708N		8	TR 91/A	TP 98	TP 99	3,436	-	6
16162709	16162709N		9	TR 91/A	TP 98	TP 99	3,828	-	6
16162710	16162710N		10	TR 91/A	TP 98	TP 99	4,220	-	6
16162711	16162711N		11	TR 91/A	TP 98	TP 99	4,612	-	6
16162712	16162712N		12	TR 91/A	TP 98	TP 99	5,004	-	6





Collettore di distribuzione premontato con detentori incorporati predisposto per la doppia regolazione.







CD 449

finitura gialla	finitura nichelata	MISURA	N. VIE						
COD.	COD.								
15212402	15212402N	G 1" x (W24x19)	2	TR 91	TP 95	TP 97	0,620	-	25
15212403	15212403N		3	TR 91	TP 95	TP 97	0,920	-	20
15212404	15212404N		4	TR 91	TP 95	TP 97	1,220	-	15
15212405	15212405N		5	TR 91	TP 95	TP 97	1,520	-	15
15212406	15212406N		6	TR 91	TP 95	TP 97	1,820	-	10
15212407	15212407N		7	TR 91	TP 95	TP 97	2,120	-	10
15212408	15212408N		8	TR 91	TP 95	TP 97	2,420	-	10
15212409	15212409N		9	TR 91	TP 95	TP 97	2,720	-	10
15212410	15212410N		10	TR 91	TP 95	TP 97	3,020	-	10
15212411	15212411N		11	TR 91	TP 95	TP 97	3,320	-	10
15212412	15212412N		12	TR 91	TP 95	TP 97	3,620	-	10

CD 448

finitura gialla	finitura nichelata	MISURA	N. VIE						
COD.	COD.								
15212702	15212702N	G 1" x G 3/4 EK	2	TR 91/A	TP 98	TP 99	0,640	-	25
15212703	15212703N		3	TR 91/A	TP 98	TP 99	0,950	-	20
15212704	15212704N		4	TR 91/A	TP 98	TP 99	1,260	-	15
15212705	15212705N		5	TR 91/A	TP 98	TP 99	1,570	-	15
15212706	15212706N		6	TR 91/A	TP 98	TP 99	1,880	-	10
15212707	15212707N		7	TR 91/A	TP 98	TP 99	2,190	-	10
15212708	15212708N		8	TR 91/A	TP 98	TP 99	2,500	-	10
15212709	15212709N		9	TR 91/A	TP 98	TP 99	2,810	-	10
15212710	15212710N		10	TR 91/A	TP 98	TP 99	3,120	-	10
15212711	15212711N		11	TR 91/A	TP 98	TP 99	3,430	-	10
15212712	15212712N		12	TR 91/A	TP 98	TP 99	3,740	-	10

CD 879

finitura gialla	finitura nichelata	MISURA	N. VIE						
COD.	COD.								
16212402	16212402N	G 1 1/4 x (W24x19)	2	TR 91	TP 95	TP 97	0,770	-	15
16212403	16212403N		3	TR 91	TP 95	TP 97	1,130	-	12
16212404	16212404N		4	TR 91	TP 95	TP 97	1,490	-	10
16212405	16212405N		5	TR 91	TP 95	TP 97	1,850	-	10
16212406	16212406N		6	TR 91	TP 95	TP 97	2,210	-	8
16212407	16212407N		7	TR 91	TP 95	TP 97	2,570	-	8
16212408	16212408N		8	TR 91	TP 95	TP 97	2,930	-	8
16212409	16212409N		9	TR 91	TP 95	TP 97	3,290	-	8
16212410	16212410N		10	TR 91	TP 95	TP 97	3,650	-	8
16212411	16212411N		11	TR 91	TP 95	TP 97	4,010	-	8
16212412	16212412N		12	TR 91	TP 95	TP 97	4,370	-	8

CD 880

finitura gialla	finitura nichelata	MISURA	N. VIE						
COD.	COD.								
16212702	16212702N	G 1 1/4 x G 3/4 EK	2	TR 91/A	TP 98	TP 99	0,790	-	15
16212703	16212703N		3	TR 91/A	TP 98	TP 99	1,160	-	12
16212704	16212704N		4	TR 91/A	TP 98	TP 99	1,530	-	10
16212705	16212705N		5	TR 91/A	TP 98	TP 99	1,900	-	10
16212706	16212706N		6	TR 91/A	TP 98	TP 99	2,270	-	8
16212707	16212707N		7	TR 91/A	TP 98	TP 99	2,640	-	8
16212708	16212708N		8	TR 91/A	TP 98	TP 99	3,010	-	8
16212709	16212709N		9	TR 91/A	TP 98	TP 99	3,380	-	8
16212710	16212710N		10	TR 91/A	TP 98	TP 99	3,750	-	8
16212711	16212711N		11	TR 91/A	TP 98	TP 99	4,120	-	8
16212712	16212712N		12	TR 91/A	TP 98	TP 99	4,490	-	8



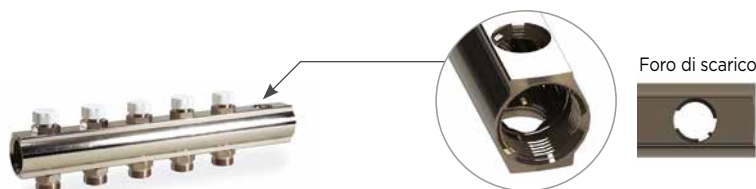







Foro di scarico

Collettore di distribuzione con 2 fori di scarico da 1/2 premontato con detentori incorporati predisposto per la doppia regolazione.

CD 1449

finitura gialla	finitura nichelata	MISURA	N. VIE						
COD.	COD.								
15222402	15222402N	G 1" x (W24x19)	2	TR 91	TP 95	TP 97	0,810	-	20
15222403	15222403N		3	TR 91	TP 95	TP 97	1,110	-	15
15222404	15222404N		4	TR 91	TP 95	TP 97	1,410	-	15
15222405	15222405N		5	TR 91	TP 95	TP 97	1,710	-	10
15222406	15222406N		6	TR 91	TP 95	TP 97	2,010	-	10
15222407	15222407N		7	TR 91	TP 95	TP 97	2,310	-	10
15222408	15222408N		8	TR 91	TP 95	TP 97	2,610	-	10
15222409	15222409N		9	TR 91	TP 95	TP 97	2,910	-	10
15222410	15222410N		10	TR 91	TP 95	TP 97	3,210	-	10
15222411	15222411N		11	TR 91	TP 95	TP 97	3,510	-	10
15222412	15222412N		12	TR 91	TP 95	TP 97	3,810	-	10

CD 1448

finitura gialla	finitura nichelata	MISURA	N. VIE						
COD.	COD.								
15222702	15222702N	G 1" x G 3/4 EK	2	TR 91/A	TP 98	TP 99	0,830	-	20
15222703	15222703N		3	TR 91/A	TP 98	TP 99	1,140	-	15
15222704	15222704N		4	TR 91/A	TP 98	TP 99	1,450	-	15
15222705	15222705N		5	TR 91/A	TP 98	TP 99	1,760	-	10
15222706	15222706N		6	TR 91/A	TP 98	TP 99	2,070	-	10
15222707	15222707N		7	TR 91/A	TP 98	TP 99	2,380	-	10
15222708	15222708N		8	TR 91/A	TP 98	TP 99	2,690	-	10
15222709	15222709N		9	TR 91/A	TP 98	TP 99	3,000	-	10
15222710	15222710N		10	TR 91/A	TP 98	TP 99	3,310	-	10
15222711	15222711N		11	TR 91/A	TP 98	TP 99	3,620	-	10
15222712	15222712N		12	TR 91/A	TP 98	TP 99	3,930	-	10

CD 881

finitura gialla	finitura nichelata	MISURA	N. VIE						
COD.	COD.								
16222402	16222402N	G 1 1/4 x (W24x19)	2	TR 91	TP 95	TP 97	1,020	-	12
16222403	16222403N		3	TR 91	TP 95	TP 97	1,380	-	10
16222404	16222404N		4	TR 91	TP 95	TP 97	1,740	-	10
16222405	16222405N		5	TR 91	TP 95	TP 97	2,100	-	8
16222406	16222406N		6	TR 91	TP 95	TP 97	2,460	-	8
16222407	16222407N		7	TR 91	TP 95	TP 97	2,820	-	6
16222408	16222408N		8	TR 91	TP 95	TP 97	3,180	-	6
16222409	16222409N		9	TR 91	TP 95	TP 97	3,540	-	6
16222410	16222410N		10	TR 91	TP 95	TP 97	3,900	-	6
16222411	16222411N		11	TR 91	TP 95	TP 97	4,260	-	6
16222412	16222412N		12	TR 91	TP 95	TP 97	4,620	-	6

CD 882





finitura gialla	finitura nichelata	MISURA	N. VIE						
COD.	COD.								
16222702	16222702N	G 1 1/4 x G 3/4 EK	2	TR 91/A	TP 98	TP 99	1,040	-	12
16222703	16222703N		3	TR 91/A	TP 98	TP 99	1,410	-	10
16222704	16222704N		4	TR 91/A	TP 98	TP 99	1,780	-	10
16222705	16222705N		5	TR 91/A	TP 98	TP 99	2,150	-	8
16222706	16222706N		6	TR 91/A	TP 98	TP 99	2,520	-	8
16222707	16222707N		7	TR 91/A	TP 98	TP 99	2,890	-	6
16222708	16222708N		8	TR 91/A	TP 98	TP 99	3,260	-	6
16222709	16222709N		9	TR 91/A	TP 98	TP 99	3,630	-	6
16222710	16222710N		10	TR 91/A	TP 98	TP 99	4,000	-	6
16222711	16222711N		11	TR 91/A	TP 98	TP 99	4,370	-	6
16222712	16222712N		12	TR 91/A	TP 98	TP 99	4,740	-	6





Collettore di distribuzione premontato
con regolatori e misuratori di portata.

CD 1474

finitura gialla	finitura nichelata	MISURA	N. VIE						
COD.	COD.								
15252402	15252402N	G 1" x (W24x19)	2	TR 91	TP 95	TP 97	0,678	-	18
15252403	15252403N		3	TR 91	TP 95	TP 97	0,992	-	12
15252404	15252404N		4	TR 91	TP 95	TP 97	1,316	-	7
15252405	15252405N		5	TR 91	TP 95	TP 97	1,680	-	7
15252406	15252406N		6	TR 91	TP 95	TP 97	1,984	-	6
15252407	15252407N		7	TR 91	TP 95	TP 97	2,308	-	5
15252408	15252408N		8	TR 91	TP 95	TP 97	2,642	-	4
15252409	15252409N		9	TR 91	TP 95	TP 97	2,956	-	4
15252410	15252410N		10	TR 91	TP 95	TP 97	3,280	-	5
15252411	15252411N		11	TR 91	TP 95	TP 97	3,604	-	5
15252412	15252412N		12	TR 91	TP 95	TP 97	3,908	-	5

CD 474

finitura gialla	finitura nichelata	MISURA	N. VIE						
COD.	COD.								
15252702	15252702N	G 1" x G 3/4 EK	2	TR 91/A	TP 98	TP 99	0,688	-	18
15252703	15252703N		3	TR 91/A	TP 98	TP 99	1,007	-	12
15252704	15252704N		4	TR 91/A	TP 98	TP 99	1,336	-	7
15252705	15252705N		5	TR 91/A	TP 98	TP 99	1,705	-	7
15252706	15252706N		6	TR 91/A	TP 98	TP 99	2,014	-	6
15252707	15252707N		7	TR 91/A	TP 98	TP 99	2,343	-	5
15252708	15252708N		8	TR 91/A	TP 98	TP 99	2,682	-	4
15252709	15252709N		9	TR 91/A	TP 98	TP 99	3,008	-	4
15252710	15252710N		10	TR 91/A	TP 98	TP 99	3,330	-	5
15252711	15252711N		11	TR 91/A	TP 98	TP 99	3,659	-	5
15252712	15252712N		12	TR 91/A	TP 98	TP 99	3,968	-	5

CD 868

finitura gialla	finitura nichelata	MISURA	N. VIE						
COD.	COD.								
16252402	16252402N	G 1 1/4 x (W24x19)	2	TR 91	TP 95	TP 97	0,854	-	14
16252403	16252403N		3	TR 91	TP 95	TP 97	1,261	-	10
16252404	16252404N		4	TR 91	TP 95	TP 97	1,658	-	6
16252405	16252405N		5	TR 91	TP 95	TP 97	2,055	-	6
16252406	16252406N		6	TR 91	TP 95	TP 97	2,462	-	5
16252407	16252407N		7	TR 91	TP 95	TP 97	2,859	-	5
16252408	16252408N		8	TR 91	TP 95	TP 97	3,236	-	4
16252409	16252409N		9	TR 91	TP 95	TP 97	3,663	-	4
16252410	16252410N		10	TR 91	TP 95	TP 97	4,060	-	5
16252411	16252411N		11	TR 91	TP 95	TP 97	4,497	-	5
16252412	16252412N		12	TR 91	TP 95	TP 97	4,874	-	5

CD 867

finitura gialla	finitura nichelata	MISURA	N. VIE						
COD.	COD.								
16252702	16252702N	G 1 1/4 x G 3/4 EK	2	TR 91/A	TP 98	TP 99	0,864	-	14
16252703	16252703N		3	TR 91/A	TP 98	TP 99	1,276	-	10
16252704	16252704N		4	TR 91/A	TP 98	TP 99	1,678	-	6
16252705	16252705N		5	TR 91/A	TP 98	TP 99	2,080	-	6
16252706	16252706N		6	TR 91/A	TP 98	TP 99	2,492	-	5
16252707	16252707N		7	TR 91/A	TP 98	TP 99	2,894	-	5
16252708	16252708N		8	TR 91/A	TP 98	TP 99	3,276	-	4
16252709	16252709N		9	TR 91/A	TP 98	TP 99	3,708	-	4
16252710	16252710N		10	TR 91/A	TP 98	TP 99	4,110	-	5
16252711	16252711N		11	TR 91/A	TP 98	TP 99	4,552	-	5
16252712	16252712N		12	TR 91/A	TP 98	TP 99	4,934	-	5



Raccordi per tubo rame



Raccordi per tubo plastica



Raccordi per tubo multistrato



Raccordi: capitolo 7



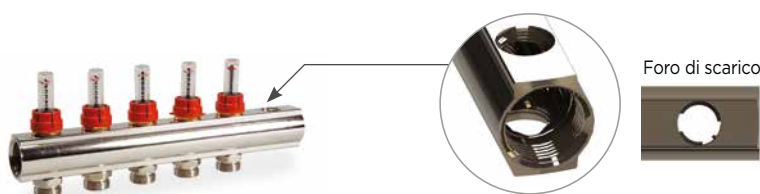

Accessori: capitolo 2.A



Foro di scarico

Collettore di distribuzione con 2 fori di scarico da 1/2 premontato con regolatori e misuratori di portata.

CD 3474

finitura gialla	finitura nichelata	MISURA	N. VIE						
COD.	COD.								
15262402	15262402N	G 1" x (W24x19)	2	TR 91	TP 95	TP 97	0,858	-	12
15262403	15262403N		3	TR 91	TP 95	TP 97	1,182	-	7
15262404	15262404N		4	TR 91	TP 95	TP 97	1,546	-	7
15262405	15262405N		5	TR 91	TP 95	TP 97	1,850	-	6
15262406	15262406N		6	TR 91	TP 95	TP 97	2,174	-	5
15262407	15262407N		7	TR 91	TP 95	TP 97	2,508	-	4
15262408	15262408N		8	TR 91	TP 95	TP 97	2,822	-	4
15262409	15262409N		9	TR 91	TP 95	TP 97	3,146	-	5
15262410	15262410N		10	TR 91	TP 95	TP 97	3,470	-	5
15262411	15262411N		11	TR 91	TP 95	TP 97	3,774	-	5
15262412	15262412N		12	TR 91	TP 95	TP 97	4,128	-	4

CD 2474

finitura gialla	finitura nichelata	MISURA	N. VIE						
COD.	COD.								
15262702	15262702N	G 1" x G 3/4 EK	2	TR 91/A	TP 98	TP 99	0,868	-	12
15262703	15262703N		3	TR 91/A	TP 98	TP 99	1,197	-	7
15262704	15262704N		4	TR 91/A	TP 98	TP 99	1,566	-	7
15262705	15262705N		5	TR 91/A	TP 98	TP 99	1,875	-	6
15262706	15262706N		6	TR 91/A	TP 98	TP 99	2,204	-	5
15262707	15262707N		7	TR 91/A	TP 98	TP 99	2,543	-	4
15262708	15262708N		8	TR 91/A	TP 98	TP 99	2,862	-	4
15262709	15262709N		9	TR 91/A	TP 98	TP 99	3,191	-	5
15262710	15262710N		10	TR 91/A	TP 98	TP 99	3,520	-	5
15262711	15262711N		11	TR 91/A	TP 98	TP 99	3,829	-	5
15262712	15262712N		12	TR 91/A	TP 98	TP 99	4,188	-	4

CD 870

finitura gialla	finitura nichelata	MISURA	N. VIE						
COD.	COD.								
16262402	16262402N	G 1 1/4 x (W24x19)	2	TR 91	TP 95	TP 97	1,114	-	10
16262403	16262403N		3	TR 91	TP 95	TP 97	1,511	-	6
16262404	16262404N		4	TR 91	TP 95	TP 97	1,908	-	6
16262405	16262405N		5	TR 91	TP 95	TP 97	2,315	-	5
16262406	16262406N		6	TR 91	TP 95	TP 97	2,712	-	5
16262407	16262407N		7	TR 91	TP 95	TP 97	3,089	-	4
16262408	16262408N		8	TR 91	TP 95	TP 97	3,516	-	4
16262409	16262409N		9	TR 91	TP 95	TP 97	3,913	-	5
16262410	16262410N		10	TR 91	TP 95	TP 97	4,350	-	5
16262411	16262411N		11	TR 91	TP 95	TP 97	4,727	-	5
16262412	16262412N		12	TR 91	TP 95	TP 97	5,104	-	4

CD 869

finitura gialla	finitura nichelata	MISURA	N. VIE						
COD.	COD.								
16262702	16262702N	G 1 1/4 x G 3/4 EK	2	TR 91/A	TP 98	TP 99	1,124	-	10
16262703	16262703N		3	TR 91/A	TP 98	TP 99	1,526	-	6
16262704	16262704N		4	TR 91/A	TP 98	TP 99	1,928	-	6
16262705	16262705N		5	TR 91/A	TP 98	TP 99	2,340	-	5
16262706	16262706N		6	TR 91/A	TP 98	TP 99	2,742	-	5
16262707	16262707N		7	TR 91/A	TP 98	TP 99	3,124	-	4
16262708	16262708N		8	TR 91/A	TP 98	TP 99	3,556	-	4
16262709	16262709N		9	TR 91/A	TP 98	TP 99	3,958	-	5
16262710	16262710N		10	TR 91/A	TP 98	TP 99	4,400	-	5
16262711	16262711N		11	TR 91/A	TP 98	TP 99	4,782	-	5
16262712	16262712N		12	TR 91/A	TP 98	TP 99	5,164	-	4









Collettore di distribuzione premontato con vitone manuale con dischetti in alluminio per indicazioni utenze.



CD 101

finitura gialla	finitura nichelata	MISURA	N. VIE						
COD.	COD.								
15312402	15312402N	G 1" x (W24x19)	2	TR 91	TP 95	TP 97	0,642	-	24
15312403	15312403N		3	TR 91	TP 95	TP 97	0,933	-	18
15312404	15312404N		4	TR 91	TP 95	TP 97	1,244	-	12
15312405	15312405N		5	TR 91	TP 95	TP 97	1,555	-	10
15312406	15312406N		6	TR 91	TP 95	TP 97	1,866	-	9
15312407	15312407N		7	TR 91	TP 95	TP 97	2,177	-	8
15312408	15312408N		8	TR 91	TP 95	TP 97	2,468	-	8
15312409	15312409N		9	TR 91	TP 95	TP 97	2,809	-	8
15312410	15312410N		10	TR 91	TP 95	TP 97	3,090	-	8
15312411	15312411N		11	TR 91	TP 95	TP 97	3,401	-	8
15312412	15312412N		12	TR 91	TP 95	TP 97	3,692	-	8

CD 100

finitura gialla	finitura nichelata	MISURA	N. VIE						
COD.	COD.								
15312702	15312702N	G 1" x G 3/4 EK	2	TR 91/A	TP 98	TP 99	0,660	-	24
15312703	15312703N		3	TR 91/A	TP 98	TP 99	0,960	-	18
15312704	15312704N		4	TR 91/A	TP 98	TP 99	1,280	-	12
15312705	15312705N		5	TR 91/A	TP 98	TP 99	1,600	-	10
15312706	15312706N		6	TR 91/A	TP 98	TP 99	1,920	-	9
15312707	15312707N		7	TR 91/A	TP 98	TP 99	2,240	-	8
15312708	15312708N		8	TR 91/A	TP 98	TP 99	2,540	-	8
15312709	15312709N		9	TR 91/A	TP 98	TP 99	2,890	-	8
15312710	15312710N		10	TR 91/A	TP 98	TP 99	3,180	-	8
15312711	15312711N		11	TR 91/A	TP 98	TP 99	3,500	-	8
15312712	15312712N		12	TR 91/A	TP 98	TP 99	3,800	-	8



Collettore di distribuzione composto da:
 • 2 collettori con raccordi premontati RD900
 • 2 supporti metallici.



CD 3459

finitura gialla		finitura nichelata		MISURA	N. VIE	TR 91	TP 95	TP 97	RD900	Supporto	Cassa
COD.	COD.	COD.	COD.								
15412402	15412402N			G 1" x (W24x19)	2	TR 91	TP 95	TP 97	1,512	1	-
15412403	15412403N				3	TR 91	TP 95	TP 97	2,008	1	-
15412404	15412404N				4	TR 91	TP 95	TP 97	2,504	1	-
15412405	15412405N				5	TR 91	TP 95	TP 97	3,000	1	-
15412406	15412406N				6	TR 91	TP 95	TP 97	3,496	1	-
15412407	15412407N				7	TR 91	TP 95	TP 97	3,992	1	-
15412408	15412408N				8	TR 91	TP 95	TP 97	4,488	1	-
15412409	15412409N				9	TR 91	TP 95	TP 97	4,984	1	-
15412410	15412410N				10	TR 91	TP 95	TP 97	5,480	1	-
15412411	15412411N				11	TR 91	TP 95	TP 97	5,976	1	-
15412412	15412412N				12	TR 91	TP 95	TP 97	6,472	1	-

CD 3461

finitura gialla		finitura nichelata		MISURA	N. VIE	TR 91/A	TP 98	TP 99	RD900	Supporto	Cassa
COD.	COD.	COD.	COD.								
15412702	15412702N			G 1" x G 3/4 EK	2	TR 91/A	TP 98	TP 99	1,560	1	-
15412703	15412703N				3	TR 91/A	TP 98	TP 99	2,080	1	-
15412704	15412704N				4	TR 91/A	TP 98	TP 99	2,600	1	-
15412705	15412705N				5	TR 91/A	TP 98	TP 99	3,130	1	-
15412706	15412706N				6	TR 91/A	TP 98	TP 99	3,640	1	-
15412707	15412707N				7	TR 91/A	TP 98	TP 99	4,160	1	-
15412708	15412708N				8	TR 91/A	TP 98	TP 99	4,680	1	-
15412709	15412709N				9	TR 91/A	TP 98	TP 99	5,200	1	-
15412710	15412710N				10	TR 91/A	TP 98	TP 99	5,720	1	-
15412711	15412711N				11	TR 91/A	TP 98	TP 99	6,240	1	-
15412712	15412712N				12	TR 91/A	TP 98	TP 99	6,760	1	-

CD 3862

finitura gialla		finitura nichelata		MISURA	N. VIE	TR 91	TP 95	TP 97	RD900	Supporto	Cassa
COD.	COD.	COD.	COD.								
16412402	16412402N			G 1"1/4 x (W24x19)	2	TR 91	TP 95	TP 97	1,912	1	-
16412403	16412403N				3	TR 91	TP 95	TP 97	2,540	1	-
16412404	16412404N				4	TR 91	TP 95	TP 97	3,164	1	-
16412405	16412405N				5	TR 91	TP 95	TP 97	3,792	1	-
16412406	16412406N				6	TR 91	TP 95	TP 97	4,416	1	-
16412407	16412407N				7	TR 91	TP 95	TP 97	5,044	1	-
16412408	16412408N				8	TR 91	TP 95	TP 97	5,680	1	-
16412409	16412409N				9	TR 91	TP 95	TP 97	6,296	1	-
16412410	16412410N				10	TR 91	TP 95	TP 97	6,920	1	-
16412411	16412411N				11	TR 91	TP 95	TP 97	7,548	1	-
16412412	16412412N				12	TR 91	TP 95	TP 97	8,172	1	-

CD 3864

finitura gialla		finitura nichelata		MISURA	N. VIE	TR 91/A	TP 98	TP 99	RD900	Supporto	Cassa
COD.	COD.	COD.	COD.								
16412702	16412702N			G 1"1/4 x G 3/4 EK	2	TR 91/A	TP 98	TP 99	1,960	1	-
16412703	16412703N				3	TR 91/A	TP 98	TP 99	2,618	1	-
16412704	16412704N				4	TR 91/A	TP 98	TP 99	3,260	1	-
16412705	16412705N				5	TR 91/A	TP 98	TP 99	3,912	1	-
16412706	16412706N				6	TR 91/A	TP 98	TP 99	4,560	1	-
16412707	16412707N				7	TR 91/A	TP 98	TP 99	5,212	1	-
16412708	16412708N				8	TR 91/A	TP 98	TP 99	5,860	1	-
16412709	16412709N				9	TR 91/A	TP 98	TP 99	6,512	1	-
16412710	16412710N				10	TR 91/A	TP 98	TP 99	7,160	1	-
16412711	16412711N				11	TR 91/A	TP 98	TP 99	7,812	1	-
16412712	16412712N				12	TR 91/A	TP 98	TP 99	8,460	1	-

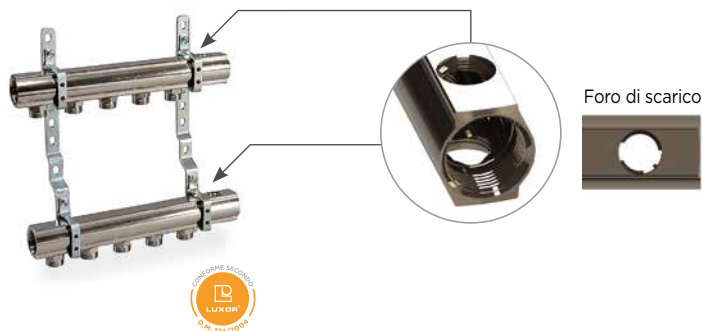

Foro di scarico

Collettore di distribuzione con 2 fori di scarico da 1/2 composto da:

- 2 collettori con raccordi premontati RD900
- 2 supporti metallici.

**CD 3460**

finitura gialla	finitura nichelata	MISURA	N. VIE							
COD.	COD.									
15422402	15422402N	G 1" x (W24x19)	2	TR 91	TP 95	TP 97	1,450	1	-	
15422403	15422403N		3	TR 91	TP 95	TP 97	1,946	1	-	
15422404	15422404N		4	TR 91	TP 95	TP 97	2,442	1	-	
15422405	15422405N		5	TR 91	TP 95	TP 97	2,938	1	-	
15422406	15422406N		6	TR 91	TP 95	TP 97	3,434	1	-	
15422407	15422407N		7	TR 91	TP 95	TP 97	3,930	1	-	
15422408	15422408N		8	TR 91	TP 95	TP 97	4,426	1	-	
15422409	15422409N		9	TR 91	TP 95	TP 97	4,922	1	-	
15422410	15422410N		10	TR 91	TP 95	TP 97	5,418	1	-	
15422411	15422411N		11	TR 91	TP 95	TP 97	5,914	1	-	
15422412	15422412N		12	TR 91	TP 95	TP 97	6,410	1	-	

CD 3462

finitura gialla	finitura nichelata	MISURA	N. VIE							
COD.	COD.									
15422702	15422702N	G 1" x G 3/4 EK	2	TR 91/A	TP 98	TP 99	1,489	1	-	
15422703	15422703N		3	TR 91/A	TP 98	TP 99	2,009	1	-	
15422704	15422704N		4	TR 91/A	TP 98	TP 99	2,529	1	-	
15422705	15422705N		5	TR 91/A	TP 98	TP 99	3,049	1	-	
15422706	15422706N		6	TR 91/A	TP 98	TP 99	3,569	1	-	
15422707	15422707N		7	TR 91/A	TP 98	TP 99	4,089	1	-	
15422708	15422708N		8	TR 91/A	TP 98	TP 99	4,609	1	-	
15422709	15422709N		9	TR 91/A	TP 98	TP 99	5,129	1	-	
15422710	15422710N		10	TR 91/A	TP 98	TP 99	5,649	1	-	
15422711	15422711N		11	TR 91/A	TP 98	TP 99	6,169	1	-	
15422712	15422712N		12	TR 91/A	TP 98	TP 99	6,689	1	-	

CD 3863

finitura gialla	finitura nichelata	MISURA	N. VIE							
COD.	COD.									
16422402	16422402N	G 1"1/4 x (W24x19)	2	TR 91	TP 95	TP 97	1,850	1	-	
16422403	16422403N		3	TR 91	TP 95	TP 97	2,478	1	-	
16422404	16422404N		4	TR 91	TP 95	TP 97	3,102	1	-	
16422405	16422405N		5	TR 91	TP 95	TP 97	3,730	1	-	
16422406	16422406N		6	TR 91	TP 95	TP 97	4,354	1	-	
16422407	16422407N		7	TR 91	TP 95	TP 97	4,982	1	-	
16422408	16422408N		8	TR 91	TP 95	TP 97	5,606	1	-	
16422409	16422409N		9	TR 91	TP 95	TP 97	6,234	1	-	
16422410	16422410N		10	TR 91	TP 95	TP 97	6,858	1	-	
16422411	16422411N		11	TR 91	TP 95	TP 97	7,486	1	-	
16422412	16422412N		12	TR 91	TP 95	TP 97	8,110	1	-	

CD 3865



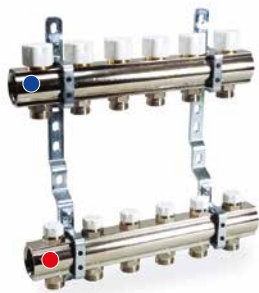



finitura gialla	finitura nichelata	MISURA	N. VIE							
COD.	COD.									
16422702	16422702N	G 1"1/4 x G 3/4 EK	2	TR 91/A	TP 98	TP 99	1,889	1	-	
16422703	16422703N		3	TR 91/A	TP 98	TP 99	2,547	1	-	
16422704	16422704N		4	TR 91/A	TP 98	TP 99	3,189	1	-	
16422705	16422705N		5	TR 91/A	TP 98	TP 99	3,841	1	-	
16422706	16422706N		6	TR 91/A	TP 98	TP 99	4,489	1	-	
16422707	16422707N		7	TR 91/A	TP 98	TP 99	5,141	1	-	
16422708	16422708N		8	TR 91/A	TP 98	TP 99	5,789	1	-	
16422709	16422709N		9	TR 91/A	TP 98	TP 99	6,441	1	-	
16422710	16422710N		10	TR 91/A	TP 98	TP 99	7,089	1	-	
16422711	16422711N		11	TR 91/A	TP 98	TP 99	7,741	1	-	
16422712	16422712N		12	TR 91/A	TP 98	TP 99	8,389	1	-	



Collettore di distribuzione composto da:

- 1 collettore di ritorno con valvole incorporate predisposte per la regolazione elettrotermica e con cappucci di protezione
- 1 collettore di andata con detentori incorporati predisposto per la doppia regolazione
- 2 supporti metallici.



CD 2465

finitura gialla	finitura nichelata	MISURA	N. VIE						
COD.	COD.								
15512402	15512402N	G 1" x (W24x19)	2	TR 91	TP 95	TP 97	1,830	1	-
15512403	15512403N		3	TR 91	TP 95	TP 97	2,442	1	-
15512404	15512404N		4	TR 91	TP 95	TP 97	3,053	1	-
15512405	15512405N		5	TR 91	TP 95	TP 97	3,665	1	-
15512406	15512406N		6	TR 91	TP 95	TP 97	4,278	1	-
15512407	15512407N		7	TR 91	TP 95	TP 97	4,890	1	-
15512408	15512408N		8	TR 91	TP 95	TP 97	5,502	1	-
15512409	15512409N		9	TR 91	TP 95	TP 97	6,114	1	-
15512410	15512410N		10	TR 91	TP 95	TP 97	6,726	1	-
15512411	15512411N		11	TR 91	TP 95	TP 97	7,338	1	-
15512412	15512412N		12	TR 91	TP 95	TP 97	7,950	1	-
15512413	15512413N		13	TR 91	TP 95	TP 97	8,562	1	-

CD 2468

finitura gialla	finitura nichelata	MISURA	N. VIE						
COD.	COD.								
15512702	15512702N	G 1" x G 3/4 EK	2	TR 91/A	TP 98	TP 99	1,870	1	-
15512703	15512703N		3	TR 91/A	TP 98	TP 99	2,502	1	-
15512704	15512704N		4	TR 91/A	TP 98	TP 99	3,134	1	-
15512705	15512705N		5	TR 91/A	TP 98	TP 99	3,766	1	-
15512706	15512706N		6	TR 91/A	TP 98	TP 99	4,398	1	-
15512707	15512707N		7	TR 91/A	TP 98	TP 99	5,030	1	-
15512708	15512708N		8	TR 91/A	TP 98	TP 99	5,662	1	-
15512709	15512709N		9	TR 91/A	TP 98	TP 99	6,294	1	-
15512710	15512710N		10	TR 91/A	TP 98	TP 99	6,926	1	-
15512711	15512711N		11	TR 91/A	TP 98	TP 99	7,558	1	-
15512712	15512712N		12	TR 91/A	TP 98	TP 99	8,190	1	-
15512713	15512713N		13	TR 91/A	TP 98	TP 99	8,822	1	-

CD 2865

finitura gialla	finitura nichelata	MISURA	N. VIE						
COD.	COD.								
16512402	16512402N	G 1" ¹ / ₄ x (W24x19)	2	TR 91	TP 95	TP 97	2,174	1	-
16512403	16512403N		3	TR 91	TP 95	TP 97	2,906	1	-
16512404	16512404N		4	TR 91	TP 95	TP 97	3,638	1	-
16512405	16512405N		5	TR 91	TP 95	TP 97	4,370	1	-
16512406	16512406N		6	TR 91	TP 95	TP 97	5,102	1	-
16512407	16512407N		7	TR 91	TP 95	TP 97	5,834	1	-
16512408	16512408N		8	TR 91	TP 95	TP 97	6,566	1	-
16512409	16512409N		9	TR 91	TP 95	TP 97	7,298	1	-
16512410	16512410N		10	TR 91	TP 95	TP 97	8,030	1	-
16512411	16512411N		11	TR 91	TP 95	TP 97	8,762	1	-
16512412	16512412N		12	TR 91	TP 95	TP 97	9,494	1	-
16512413	16512413N		13	TR 91	TP 95	TP 97	10,226	1	-

CD 2868

finitura gialla	finitura nichelata	MISURA	N. VIE						
COD.	COD.								
16512702	16512702N	G 1" ¹ / ₄ x G 3/4 EK	2	TR 91/A	TP 98	TP 99	2,214	1	-
16512703	16512703N		3	TR 91/A	TP 98	TP 99	2,966	1	-
16512704	16512704N		4	TR 91/A	TP 98	TP 99	3,718	1	-
16512705	16512705N		5	TR 91/A	TP 98	TP 99	4,470	1	-
16512706	16512706N		6	TR 91/A	TP 98	TP 99	5,222	1	-
16512707	16512707N		7	TR 91/A	TP 98	TP 99	5,974	1	-
16512708	16512708N		8	TR 91/A	TP 98	TP 99	6,726	1	-
16512709	16512709N		9	TR 91/A	TP 98	TP 99	7,478	1	-
16512710	16512710N		10	TR 91/A	TP 98	TP 99	8,230	1	-
16512711	16512711N		11	TR 91/A	TP 98	TP 99	8,982	1	-
16512712	16512712N		12	TR 91/A	TP 98	TP 99	9,734	1	-
16512713	16512713N		13	TR 91/A	TP 98	TP 99	10,486	1	-



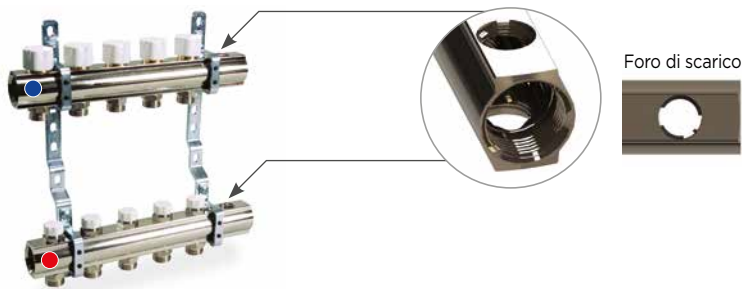

Collettore di distribuzione con 2 fori di scarico da 1/2 premontato composto da:

- 1 collettore di ritorno con valvole incorporate predisposte per la regolazione elettrotermica e con cappucci di protezione
- 1 collettore di andata con detentori incorporati predisposto per la doppia regolazione
- 2 supporti metallici.

CD 2467

finitura gialla	finitura nichelata	COD.	COD.	MISURA	N. VIE						
		15522402	15522402N	G 1" x (W24x19)	2	TR 91	TP 95	TP 97	2,210	1	-
		15522403	15522403N		3	TR 91	TP 95	TP 97	2,822	1	-
		15522404	15522404N		4	TR 91	TP 95	TP 97	3,434	1	-
		15522405	15522405N		5	TR 91	TP 95	TP 97	4,046	1	-
		15522406	15522406N		6	TR 91	TP 95	TP 97	4,658	1	-
		15522407	15522407N		7	TR 91	TP 95	TP 97	5,270	1	-
		15522408	15522408N		8	TR 91	TP 95	TP 97	5,882	1	-
		15522409	15522409N		9	TR 91	TP 95	TP 97	6,494	1	-
		15522410	15522410N		10	TR 91	TP 95	TP 97	7,106	1	-
		15522411	15522411N		11	TR 91	TP 95	TP 97	7,718	1	-
		15522412	15522412N		12	TR 91	TP 95	TP 97	8,330	1	-

CD 2469

finitura gialla	finitura nichelata	COD.	COD.	MISURA	N. VIE						
		15522702	15522702N	G 1" x G 3/4 EK	2	TR 91/A	TP 98	TP 99	2,250	1	-
		15522703	15522703N		3	TR 91/A	TP 98	TP 99	2,882	1	-
		15522704	15522704N		4	TR 91/A	TP 98	TP 99	3,514	1	-
		15522705	15522705N		5	TR 91/A	TP 98	TP 99	4,146	1	-
		15522706	15522706N		6	TR 91/A	TP 98	TP 99	4,778	1	-
		15522707	15522707N		7	TR 91/A	TP 98	TP 99	5,410	1	-
		15522708	15522708N		8	TR 91/A	TP 98	TP 99	6,042	1	-
		15522709	15522709N		9	TR 91/A	TP 98	TP 99	6,674	1	-
		15522710	15522710N		10	TR 91/A	TP 98	TP 99	7,306	1	-
		15522711	15522711N		11	TR 91/A	TP 98	TP 99	7,938	1	-
		15522712	15522712N		12	TR 91/A	TP 98	TP 99	8,570	1	-

CD 2867

finitura gialla	finitura nichelata	COD.	COD.	MISURA	N. VIE						
		16522402	16522402N	G 1"1/4 x (W24x19)	2	TR 91	TP 95	TP 97	2,674	1	-
		16522403	16522403N		3	TR 91	TP 95	TP 97	3,406	1	-
		16522404	16522404N		4	TR 91	TP 95	TP 97	4,138	1	-
		16522405	16522405N		5	TR 91	TP 95	TP 97	4,870	1	-
		16522406	16522406N		6	TR 91	TP 95	TP 97	5,602	1	-
		16522407	16522407N		7	TR 91	TP 95	TP 97	6,334	1	-
		16522408	16522408N		8	TR 91	TP 95	TP 97	7,066	1	-
		16522409	16522409N		9	TR 91	TP 95	TP 97	7,798	1	-
		16522410	16522410N		10	TR 91	TP 95	TP 97	8,530	1	-
		16522411	16522411N		11	TR 91	TP 95	TP 97	9,262	1	-
		16522412	16522412N		12	TR 91	TP 95	TP 97	9,994	1	-

CD 2869

finitura gialla	finitura nichelata	COD.	COD.	MISURA	N. VIE						
		16522702	16522702	G 1"1/4 x G 3/4 EK	2	TR 91/A	TP 98	TP 99	2,714	1	-
		16522703	16522703		3	TR 91/A	TP 98	TP 99	3,466	1	-
		16522704	16522704		4	TR 91/A	TP 98	TP 99	4,218	1	-
		16522705	16522705		5	TR 91/A	TP 98	TP 99	4,970	1	-
		16522706	16522706		6	TR 91/A	TP 98	TP 99	5,722	1	-
		16522707	16522707		7	TR 91/A	TP 98	TP 99	6,474	1	-
		16522708	16522708		8	TR 91/A	TP 98	TP 99	7,226	1	-
		16522709	16522709		9	TR 91/A	TP 98	TP 99	7,978	1	-
		16522710	16522710		10	TR 91/A	TP 98	TP 99	8,730	1	-
		16522711	16522711		11	TR 91/A	TP 98	TP 99	9,482	1	-
		16522712	16522712		12	TR 91/A	TP 98	TP 99	10,234	1	-



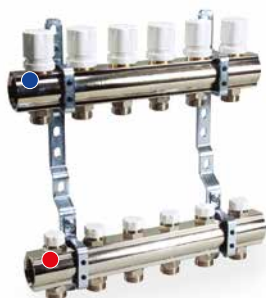





Collettore di distribuzione premontato composto da:

- 1 collettore di ritorno con valvole incorporate predisposte per la regolazione elettrotermica e con volantino di comando manuale
- 1 collettore di andata con detentori incorporati predisposto per la doppia regolazione
- 2 supporti metallici.







CD 465

finitura gialla	finitura nichelata	MISURA	N. VIE						
COD.	COD.								
15552402	15552402N	G 1" x (W24x19)	2	TR 91	TP 95	TP 97	1,850	1	-
15552403	15552403N		3	TR 91	TP 95	TP 97	2,472	1	-
15552404	15552404N		4	TR 91	TP 95	TP 97	3,094	1	-
15552405	15552405N		5	TR 91	TP 95	TP 97	3,716	1	-
15552406	15552406N		6	TR 91	TP 95	TP 97	4,338	1	-
15552407	15552407N		7	TR 91	TP 95	TP 97	4,960	1	-
15552408	15552408N		8	TR 91	TP 95	TP 97	5,582	1	-
15552409	15552409N		9	TR 91	TP 95	TP 97	6,204	1	-
15552410	15552410N		10	TR 91	TP 95	TP 97	6,826	1	-
15552411	15552411N		11	TR 91	TP 95	TP 97	7,448	1	-
15552412	15552412N		12	TR 91	TP 95	TP 97	8,070	1	-
15552413	15552413N		13	TR 91	TP 95	TP 97	8,692	1	-

CD 468

finitura gialla	finitura nichelata	MISURA	N. VIE						
COD.	COD.								
15552702	15552702N	G 1" x G 3/4 EK	2	TR 91/A	TP 98	TP 99	1,890	1	-
15552703	15552703N		3	TR 91/A	TP 98	TP 99	2,532	1	-
15552704	15552704N		4	TR 91/A	TP 98	TP 99	3,174	1	-
15552705	15552705N		5	TR 91/A	TP 98	TP 99	3,816	1	-
15552706	15552706N		6	TR 91/A	TP 98	TP 99	4,458	1	-
15552707	15552707N		7	TR 91/A	TP 98	TP 99	5,100	1	-
15552708	15552708N		8	TR 91/A	TP 98	TP 99	5,742	1	-
15552709	15552709N		9	TR 91/A	TP 98	TP 99	6,384	1	-
15552710	15552710N		10	TR 91/A	TP 98	TP 99	7,026	1	-
15552711	15552711N		11	TR 91/A	TP 98	TP 99	7,668	1	-
15552712	15552712N		12	TR 91/A	TP 98	TP 99	8,310	1	-
15552713	15552713N		13	TR 91/A	TP 98	TP 99	8,952	1	-

CD 1865

finitura gialla	finitura nichelata	MISURA	N. VIE						
COD.	COD.								
16552402	16552402N	G 1 1/4 x (W24x19)	2	TR 91	TP 95	TP 97	2,194	1	-
16552403	16552403N		3	TR 91	TP 95	TP 97	2,936	1	-
16552404	16552404N		4	TR 91	TP 95	TP 97	3,678	1	-
16552405	16552405N		5	TR 91	TP 95	TP 97	4,420	1	-
16552406	16552406N		6	TR 91	TP 95	TP 97	5,162	1	-
16552407	16552407N		7	TR 91	TP 95	TP 97	5,904	1	-
16552408	16552408N		8	TR 91	TP 95	TP 97	6,646	1	-
16552409	16552409N		9	TR 91	TP 95	TP 97	7,388	1	-
16552410	16552410N		10	TR 91	TP 95	TP 97	8,130	1	-
16552411	16552411N		11	TR 91	TP 95	TP 97	8,872	1	-
16552412	16552412N		12	TR 91	TP 95	TP 97	9,614	1	-
16552413	16552413N		13	TR 91	TP 95	TP 97	10,356	1	-

CD 1868

finitura gialla	finitura nichelata	MISURA	N. VIE						
COD.	COD.								
16552702	16552702N	G 1 1/4 x G 3/4 EK	2	TR 91/A	TP 98	TP 99	2,234	1	-
16552703	16552703N		3	TR 91/A	TP 98	TP 99	2,996	1	-
16552704	16552704N		4	TR 91/A	TP 98	TP 99	3,758	1	-
16552705	16552705N		5	TR 91/A	TP 98	TP 99	4,520	1	-
16552706	16552706N		6	TR 91/A	TP 98	TP 99	5,282	1	-
16552707	16552707N		7	TR 91/A	TP 98	TP 99	6,044	1	-
16552708	16552708N		8	TR 91/A	TP 98	TP 99	6,806	1	-
16552709	16552709N		9	TR 91/A	TP 98	TP 99	7,568	1	-
16552710	16552710N		10	TR 91/A	TP 98	TP 99	8,330	1	-
16552711	16552711N		11	TR 91/A	TP 98	TP 99	9,092	1	-
16552712	16552712N		12	TR 91/A	TP 98	TP 99	9,854	1	-
16552713	16552713N		13	TR 91/A	TP 98	TP 99	10,616	1	-



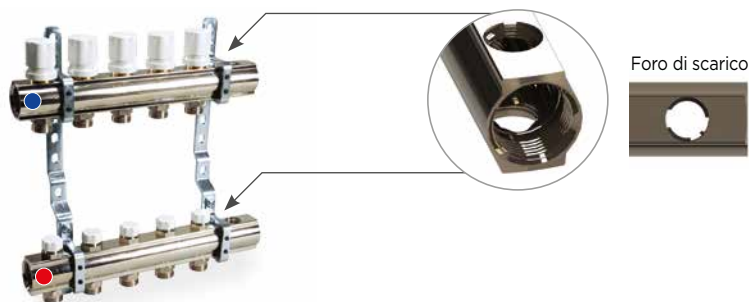

Collettore di distribuzione con 2 fori di scarico da 1/2 premontato composto da:

- 1 collettore di ritorno con valvole incorporate predisposte per la regolazione elettrotermica e con volantino di comando manuale
- 1 collettore di andata con detentori incorporati predisposto per la doppia regolazione
- 2 supporti metallici.

CD 467

finitura gialla	finitura nichelata	MISURA	N. VIE						
COD.	COD.								
15562402	15562402N	G 1" x (W24x19)	2	TR 91	TP 95	TP 97	2,230	1	-
15562403	15562403N		3	TR 91	TP 95	TP 97	2,852	1	-
15562404	15562404N		4	TR 91	TP 95	TP 97	3,474	1	-
15562405	15562405N		5	TR 91	TP 95	TP 97	4,096	1	-
15562406	15562406N		6	TR 91	TP 95	TP 97	4,718	1	-
15562407	15562407N		7	TR 91	TP 95	TP 97	5,340	1	-
15562408	15562408N		8	TR 91	TP 95	TP 97	5,962	1	-
15562409	15562409N		9	TR 91	TP 95	TP 97	6,584	1	-
15562410	15562410N		10	TR 91	TP 95	TP 97	7,206	1	-
15562411	15562411N		11	TR 91	TP 95	TP 97	7,828	1	-
15562412	15562412N		12	TR 91	TP 95	TP 97	8,450	1	-

CD 469

finitura gialla	finitura nichelata	MISURA	N. VIE						
COD.	COD.								
15562702	15562702N	G 1" x G 3/4 EK	2	TR 91/A	TP 98	TP 99	2,270	1	-
15562703	15562703N		3	TR 91/A	TP 98	TP 99	2,912	1	-
15562704	15562704N		4	TR 91/A	TP 98	TP 99	3,554	1	-
15562705	15562705N		5	TR 91/A	TP 98	TP 99	4,196	1	-
15562706	15562706N		6	TR 91/A	TP 98	TP 99	4,838	1	-
15562707	15562707N		7	TR 91/A	TP 98	TP 99	5,480	1	-
15562708	15562708N		8	TR 91/A	TP 98	TP 99	6,122	1	-
15562709	15562709N		9	TR 91/A	TP 98	TP 99	6,764	1	-
15562710	15562710N		10	TR 91/A	TP 98	TP 99	7,406	1	-
15562711	15562711N		11	TR 91/A	TP 98	TP 99	8,048	1	-
15562712	15562712N		12	TR 91/A	TP 98	TP 99	8,690	1	-

CD 1867

finitura gialla	finitura nichelata	MISURA	N. VIE						
COD.	COD.								
16562402	16562402N	G 1"1/4 x (W24x19)	2	TR 91	TP 95	TP 97	2,694	1	-
16562403	16562403N		3	TR 91	TP 95	TP 97	3,436	1	-
16562404	16562404N		4	TR 91	TP 95	TP 97	4,178	1	-
16562405	16562405N		5	TR 91	TP 95	TP 97	4,920	1	-
16562406	16562406N		6	TR 91	TP 95	TP 97	5,662	1	-
16562407	16562407N		7	TR 91	TP 95	TP 97	6,404	1	-
16562408	16562408N		8	TR 91	TP 95	TP 97	7,146	1	-
16562409	16562409N		9	TR 91	TP 95	TP 97	7,888	1	-
16562410	16562410N		10	TR 91	TP 95	TP 97	8,630	1	-
16562411	16562411N		11	TR 91	TP 95	TP 97	9,372	1	-
16562412	16562412N		12	TR 91	TP 95	TP 97	10,114	1	-

CD 1869

finitura gialla	finitura nichelata	MISURA	N. VIE						
COD.	COD.								
16562702	16562702N	G 1"1/4 x G 3/4 EK	2	TR 91/A	TP 98	TP 99	2,734	1	-
16562703	16562703N		3	TR 91/A	TP 98	TP 99	3,496	1	-
16562704	16562704N		4	TR 91/A	TP 98	TP 99	4,258	1	-
16562705	16562705N		5	TR 91/A	TP 98	TP 99	5,020	1	-
16562706	16562706N		6	TR 91/A	TP 98	TP 99	5,782	1	-
16562707	16562707N		7	TR 91/A	TP 98	TP 99	6,544	1	-
16562708	16562708N		8	TR 91/A	TP 98	TP 99	7,306	1	-
16562709	16562709N		9	TR 91/A	TP 98	TP 99	8,068	1	-
16562710	16562710N		10	TR 91/A	TP 98	TP 99	8,830	1	-
16562711	16562711N		11	TR 91/A	TP 98	TP 99	9,592	1	-
16562712	16562712N		12	TR 91/A	TP 98	TP 99	10,354	1	-



Raccordi per tubo rame



Raccordi per tubo plastica



Raccordi per tubo multistrato



Raccordi: capitolo 7









Accessori: capitolo 2.A



Collettore di distribuzione premontato composto da:

- 1 collettore di ritorno con valvole incorporate predisposte per la regolazione elettrotermica e con cappucci di protezione
- 1 collettore di andata con regolatori misuratori di portata
- 2 supporti metallici.







CD 2478

finitura gialla	finitura nichelata	MISURA	N. VIE						
COD.	COD.								
15612402	15612402N	G 1" x (W24x19)	2	TR 91	TP 95	TP 97	1,562	1	-
15612403	15612403N		3	TR 91	TP 95	TP 97	2,188	1	-
15612404	15612404N		4	TR 91	TP 95	TP 97	2,824	1	-
15612405	15612405N		5	TR 91	TP 95	TP 97	3,500	1	-
15612406	15612406N		6	TR 91	TP 95	TP 97	4,116	1	-
15612407	15612407N		7	TR 91	TP 95	TP 97	4,752	1	-
15612408	15612408N		8	TR 91	TP 95	TP 97	5,398	1	-
15612409	15612409N		9	TR 91	TP 95	TP 97	6,024	1	-
15612410	15612410N		10	TR 91	TP 95	TP 97	6,660	1	-
15612411	15612411N		11	TR 91	TP 95	TP 97	7,296	1	-
15612412	15612412N		12	TR 91	TP 95	TP 97	7,912	1	-
15612413	15612413N		13	TR 91	TP 95	TP 97	8,528	1	-

CD 2473

finitura gialla	finitura nichelata	MISURA	N. VIE						
COD.	COD.								
15612702	15612702N	G 1" x G 3/4 EK	2	TR 91/A	TP 98	TP 99	1,592	1	-
15612703	15612703N		3	TR 91/A	TP 98	TP 99	2,233	1	-
15612704	15612704N		4	TR 91/A	TP 98	TP 99	2,884	1	-
15612705	15612705N		5	TR 91/A	TP 98	TP 99	3,575	1	-
15612706	15612706N		6	TR 91/A	TP 98	TP 99	4,206	1	-
15612707	15612707N		7	TR 91/A	TP 98	TP 99	4,857	1	-
15612708	15612708N		8	TR 91/A	TP 98	TP 99	5,518	1	-
15612709	15612709N		9	TR 91/A	TP 98	TP 99	6,159	1	-
15612710	15612710N		10	TR 91/A	TP 98	TP 99	6,810	1	-
15612711	15612711N		11	TR 91/A	TP 98	TP 99	7,461	1	-
15612712	15612712N		12	TR 91/A	TP 98	TP 99	8,092	1	-
15612713	15612713N		13	TR 91/A	TP 98	TP 99	8,723	1	-

CD 2878

finitura gialla	finitura nichelata	MISURA	N. VIE						
COD.	COD.								
16612402	16612402N	G 1" ¹ / ₄ x (W24x19)	2	TR 91	TP 95	TP 97	1,928	1	-
16612403	16612403N		3	TR 91	TP 95	TP 97	2,707	1	-
16612404	16612404N		4	TR 91	TP 95	TP 97	3,476	1	-
16612405	16612405N		5	TR 91	TP 95	TP 97	4,295	1	-
16612406	16612406N		6	TR 91	TP 95	TP 97	5,024	1	-
16612407	16612407N		7	TR 91	TP 95	TP 97	5,793	1	-
16612408	16612408N		8	TR 91	TP 95	TP 97	6,542	1	-
16612409	16612409N		9	TR 91	TP 95	TP 97	7,341	1	-
16612410	16612410N		10	TR 91	TP 95	TP 97	8,110	1	-
16612411	16612411N		11	TR 91	TP 95	TP 97	9,189	1	-
16612412	16612412N		12	TR 91	TP 95	TP 97	9,668	1	-
16612413	16612413N		13	TR 91	TP 95	TP 97	10,147	1	-

CD 2873

finitura gialla	finitura nichelata	MISURA	N. VIE						
COD.	COD.								
16612702	16612702N	G 1" ¹ / ₄ x G 3/4 EK	2	TR 91/A	TP 98	TP 99	1,958	1	-
16612703	16612703N		3	TR 91/A	TP 98	TP 99	2,752	1	-
16612704	16612704N		4	TR 91/A	TP 98	TP 99	3,536	1	-
16612705	16612705N		5	TR 91/A	TP 98	TP 99	4,320	1	-
16612706	16612706N		6	TR 91/A	TP 98	TP 99	5,114	1	-
16612707	16612707N		7	TR 91/A	TP 98	TP 99	5,898	1	-
16612708	16612708N		8	TR 91/A	TP 98	TP 99	6,662	1	-
16612709	16612709N		9	TR 91/A	TP 98	TP 99	7,476	1	-
16612710	16612710N		10	TR 91/A	TP 98	TP 99	8,260	1	-
16612711	16612711N		11	TR 91/A	TP 98	TP 99	9,084	1	-
16612712	16612712N		12	TR 91/A	TP 98	TP 99	9,848	1	-
16612713	16612713N		13	TR 91/A	TP 98	TP 99	10,612	1	-



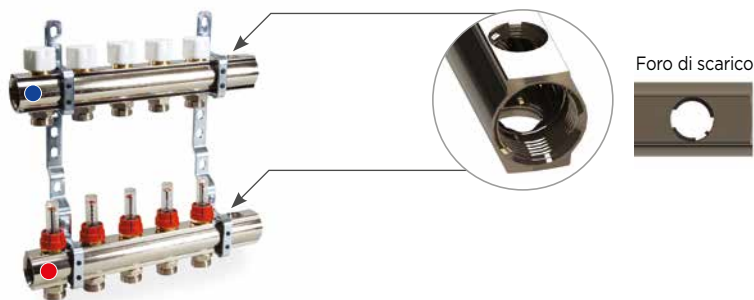







Collettore di distribuzione premontato con 2 fori di scarico da 1/2 composto da:

- 1 collettore di ritorno con valvole incorporate predisposte per la regolazione elettrotermica e con cappucci di protezione
- 1 collettore di andata con regolatori e misuratori di portata
- 2 supporti metallici.

CD 2479

finitura gialla	finitura nichelata	MISURA	N. VIE						
COD.	COD.								
15622402	15622402N	G 1" x (W24x19)	2	TR 91	TP 95	TP 97	1,932	1	-
15622403	15622403N		3	TR 91	TP 95	TP 97	2,568	1	-
15622404	15622404N		4	TR 91	TP 95	TP 97	3,244	1	-
15622405	15622405N		5	TR 91	TP 95	TP 97	3,860	1	-
15622406	15622406N		6	TR 91	TP 95	TP 97	4,496	1	-
15622407	15622407N		7	TR 91	TP 95	TP 97	5,142	1	-
15622408	15622408N		8	TR 91	TP 95	TP 97	5,768	1	-
15622409	15622409N		9	TR 91	TP 95	TP 97	6,404	1	-
15622410	15622410N		10	TR 91	TP 95	TP 97	7,040	1	-
15622411	15622411N		11	TR 91	TP 95	TP 97	7,656	1	-
15622412	15622412N		12	TR 91	TP 95	TP 97	8,322	1	-

CD 2477

finitura gialla	finitura nichelata	MISURA	N. VIE						
COD.	COD.								
15622702	15622702N	G 1" x G 3/4 EK	2	TR 91/A	TP 98	TP 99	1,962	1	-
15622703	15622703N		3	TR 91/A	TP 98	TP 99	2,613	1	-
15622704	15622704N		4	TR 91/A	TP 98	TP 99	3,304	1	-
15622705	15622705N		5	TR 91/A	TP 98	TP 99	3,935	1	-
15622706	15622706N		6	TR 91/A	TP 98	TP 99	4,586	1	-
15622707	15622707N		7	TR 91/A	TP 98	TP 99	5,247	1	-
15622708	15622708N		8	TR 91/A	TP 98	TP 99	5,888	1	-
15622709	15622709N		9	TR 91/A	TP 98	TP 99	6,539	1	-
15622710	15622710N		10	TR 91/A	TP 98	TP 99	7,190	1	-
15622711	15622711N		11	TR 91/A	TP 98	TP 99	7,821	1	-
15622712	15622712N		12	TR 91/A	TP 98	TP 99	8,502	1	-

CD 2879

finitura gialla	finitura nichelata	MISURA	N. VIE						
COD.	COD.								
16622402	16622402N	G 1"1/4 x (W24x19)	2	TR 91	TP 95	TP 97	2,438	1	-
16622403	16622403N		3	TR 91	TP 95	TP 97	3,207	1	-
16622404	16622404N		4	TR 91	TP 95	TP 97	3,976	1	-
16622405	16622405N		5	TR 91	TP 95	TP 97	4,755	1	-
16622406	16622406N		6	TR 91	TP 95	TP 97	5,524	1	-
16622407	16622407N		7	TR 91	TP 95	TP 97	6,273	1	-
16622408	16622408N		8	TR 91	TP 95	TP 97	7,072	1	-
16622409	16622409N		9	TR 91	TP 95	TP 97	7,841	1	-
16622410	16622410N		10	TR 91	TP 95	TP 97	8,650	1	-
16622411	16622411N		11	TR 91	TP 95	TP 97	9,399	1	-
16622412	16622412N		12	TR 91	TP 95	TP 97	10,148	1	-

CD 2877

finitura gialla	finitura nichelata	MISURA	N. VIE						
COD.	COD.								
16622702	16622702N	G 1"1/4 x G 3/4 EK	2	TR 91/A	TP 98	TP 99	2,468	1	-
16622703	16622703N		3	TR 91/A	TP 98	TP 99	3,252	1	-
16622704	16622704N		4	TR 91/A	TP 98	TP 99	4,036	1	-
16622705	16622705N		5	TR 91/A	TP 98	TP 99	4,830	1	-
16622706	16622706N		6	TR 91/A	TP 98	TP 99	5,614	1	-
16622707	16622707N		7	TR 91/A	TP 98	TP 99	6,378	1	-
16622708	16622708N		8	TR 91/A	TP 98	TP 99	7,192	1	-
16622709	16622709N		9	TR 91/A	TP 98	TP 99	7,976	1	-
16622710	16622710N		10	TR 91/A	TP 98	TP 99	8,800	1	-
16622711	16622711N		11	TR 91/A	TP 98	TP 99	9,564	1	-
16622712	16622712N		12	TR 91/A	TP 98	TP 99	10,328	1	-



Raccordi per tubo rame



Raccordi per tubo plastica



Raccordi per tubo multistrato



Raccordi: capitolo 7



Accessori: capitolo 2.A



Collettore di distribuzione premontato composto da:

- 1 collettore di ritorno con valvole incorporate predisposte per la regolazione elettrotermica e con volantino di comando manuale
- 1 collettore di andata con regolatori e misuratori di portata
- 2 supporti metallici.

CD 478

finitura gialla	finitura nichelata	MISURA	N. VIE						
COD.	COD.								
15652402	15652402N	G 1" x (W24x19)	2	TR 91	TP 95	TP 97	1,582	1	-
15652403	15652403N		3	TR 91	TP 95	TP 97	2,218	1	-
15652404	15652404N		4	TR 91	TP 95	TP 97	2,864	1	-
15652405	15652405N		5	TR 91	TP 95	TP 97	3,550	1	-
15652406	15652406N		6	TR 91	TP 95	TP 97	4,176	1	-
15652407	15652407N		7	TR 91	TP 95	TP 97	4,822	1	-
15652408	15652408N		8	TR 91	TP 95	TP 97	5,478	1	-
15652409	15652409N		9	TR 91	TP 95	TP 97	6,114	1	-
15652410	15652410N		10	TR 91	TP 95	TP 97	6,760	1	-
15652411	15652411N		11	TR 91	TP 95	TP 97	7,406	1	-
15652412	15652412N		12	TR 91	TP 95	TP 97	8,032	1	-
15652413	15652413N		13	TR 91	TP 95	TP 97	8,658	1	-

CD 473

finitura gialla	finitura nichelata	MISURA	N. VIE						
COD.	COD.								
15652702	15652702N	G 1" x G 3/4 EK	2	TR 91/A	TP 98	TP 99	1,612	1	-
15652703	15652703N		3	TR 91/A	TP 98	TP 99	2,263	1	-
15652704	15652704N		4	TR 91/A	TP 98	TP 99	2,924	1	-
15652705	15652705N		5	TR 91/A	TP 98	TP 99	3,625	1	-
15652706	15652706N		6	TR 91/A	TP 98	TP 99	4,266	1	-
15652707	15652707N		7	TR 91/A	TP 98	TP 99	4,927	1	-
15652708	15652708N		8	TR 91/A	TP 98	TP 99	5,598	1	-
15652709	15652709N		9	TR 91/A	TP 98	TP 99	6,249	1	-
15652710	15652710N		10	TR 91/A	TP 98	TP 99	6,910	1	-
15652711	15652711N		11	TR 91/A	TP 98	TP 99	7,571	1	-
15652712	15652712N		12	TR 91/A	TP 98	TP 99	8,212	1	-
15652713	15652713N		13	TR 91/A	TP 98	TP 99	8,853	1	-

CD 1878

finitura gialla	finitura nichelata	MISURA	N. VIE						
COD.	COD.								
16652402	16652402N	G 1"1/4 x (W24x19)	2	TR 91	TP 95	TP 97	1,948	1	-
16652403	16652403N		3	TR 91	TP 95	TP 97	2,737	1	-
16652404	16652404N		4	TR 91	TP 95	TP 97	3,516	1	-
16652405	16652405N		5	TR 91	TP 95	TP 97	4,295	1	-
16652406	16652406N		6	TR 91	TP 95	TP 97	5,084	1	-
16652407	16652407N		7	TR 91	TP 95	TP 97	5,863	1	-
16652408	16652408N		8	TR 91	TP 95	TP 97	6,622	1	-
16652409	16652409N		9	TR 91	TP 95	TP 97	7,431	1	-
16652410	16652410N		10	TR 91	TP 95	TP 97	8,210	1	-
16652411	16652411N		11	TR 91	TP 95	TP 97	9,029	1	-
16652412	16652412N		12	TR 91	TP 95	TP 97	9,788	1	-
16652413	16652413N		13	TR 91	TP 95	TP 97	10,547	1	-

CD 1873

finitura gialla	finitura nichelata	MISURA	N. VIE						
COD.	COD.								
16652702	16652702N	G 1"1/4 x G 3/4 EK	2	TR 91/A	TP 98	TP 99	1,978	1	-
16652703	16652703N		3	TR 91/A	TP 98	TP 99	2,782	1	-
16652704	16652704N		4	TR 91/A	TP 98	TP 99	3,576	1	-
16652705	16652705N		5	TR 91/A	TP 98	TP 99	4,370	1	-
16652706	16652706N		6	TR 91/A	TP 98	TP 99	5,174	1	-
16652707	16652707N		7	TR 91/A	TP 98	TP 99	5,968	1	-
16652708	16652708N		8	TR 91/A	TP 98	TP 99	6,742	1	-
16652709	16652709N		9	TR 91/A	TP 98	TP 99	7,566	1	-
16652710	16652710N		10	TR 91/A	TP 98	TP 99	8,360	1	-
16652711	16652711N		11	TR 91/A	TP 98	TP 99	9,194	1	-
16652712	16652712N		12	TR 91/A	TP 98	TP 99	9,968	1	-
16652713	16652713N		13	TR 91/A	TP 98	TP 99	10,742	1	-



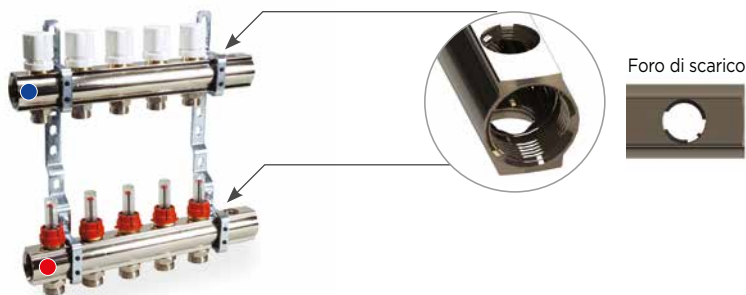







Collettore di distribuzione premontato con 2 fori di scarico da 1/2 composto da:

- 1 collettore di ritorno con valvole incorporate predisposte per la regolazione elettrotermica e con volantino di comando manuale
- 1 collettore di andata con regolatori e misuratori di portata
- 2 supporti metallici.







CD 479

finitura gialla	finitura nichelata	MISURA	N. VIE						
COD.	COD.								
15662402	15662402N	G 1" x (W24x19)	2	TR 91	TP 95	TP 97	1,952	1	-
15662403	15662403N		3	TR 91	TP 95	TP 97	2,598	1	-
15662404	15662404N		4	TR 91	TP 95	TP 97	3,284	1	-
15662405	15662405N		5	TR 91	TP 95	TP 97	3,910	1	-
15662406	15662406N		6	TR 91	TP 95	TP 97	4,556	1	-
15662407	15662407N		7	TR 91	TP 95	TP 97	5,212	1	-
15662408	15662408N		8	TR 91	TP 95	TP 97	5,848	1	-
15662409	15662409N		9	TR 91	TP 95	TP 97	6,494	1	-
15662410	15662410N		10	TR 91	TP 95	TP 97	7,140	1	-
15662411	15662411N		11	TR 91	TP 95	TP 97	7,766	1	-
15662412	15662412N		12	TR 91	TP 95	TP 97	8,442	1	-

CD 477

finitura gialla	finitura nichelata	MISURA	N. VIE						
COD.	COD.								
15662702	15662702N	G 1" x G 3/4 EK	2	TR 91/A	TP 98	TP 99	1,982	1	-
15662703	15662703N		3	TR 91/A	TP 98	TP 99	2,643	1	-
15662704	15662704N		4	TR 91/A	TP 98	TP 99	3,344	1	-
15662705	15662705N		5	TR 91/A	TP 98	TP 99	3,985	1	-
15662706	15662706N		6	TR 91/A	TP 98	TP 99	4,646	1	-
15662707	15662707N		7	TR 91/A	TP 98	TP 99	5,317	1	-
15662708	15662708N		8	TR 91/A	TP 98	TP 99	5,968	1	-
15662709	15662709N		9	TR 91/A	TP 98	TP 99	6,629	1	-
15662710	15662710N		10	TR 91/A	TP 98	TP 99	7,290	1	-
15662711	15662711N		11	TR 91/A	TP 98	TP 99	7,931	1	-
15662712	15662712N		12	TR 91/A	TP 98	TP 99	8,622	1	-

CD 1879

finitura gialla	finitura nichelata	MISURA	N. VIE						
COD.	COD.								
16662402	16662402N	G 1"1/4 x (W24x19)	2	TR 91	TP 95	TP 97	2,458	1	-
16662403	16662403N		3	TR 91	TP 95	TP 97	3,237	1	-
16662404	16662404N		4	TR 91	TP 95	TP 97	4,016	1	-
16662405	16662405N		5	TR 91	TP 95	TP 97	4,805	1	-
16662406	16662406N		6	TR 91	TP 95	TP 97	5,584	1	-
16662407	16662407N		7	TR 91	TP 95	TP 97	6,343	1	-
16662408	16662408N		8	TR 91	TP 95	TP 97	7,152	1	-
16662409	16662409N		9	TR 91	TP 95	TP 97	7,931	1	-
16662410	16662410N		10	TR 91	TP 95	TP 97	8,750	1	-
16662411	16662411N		11	TR 91	TP 95	TP 97	9,509	1	-
16662412	16662412N		12	TR 91	TP 95	TP 97	10,268	1	-

CD 1877

finitura gialla	finitura nichelata	MISURA	N. VIE						
COD.	COD.								
16662702	16662702N	G 1"1/4 x G 3/4 EK	2	TR 91/A	TP 98	TP 99	2,488	1	-
16662703	16662703N		3	TR 91/A	TP 98	TP 99	3,282	1	-
16662704	16662704N		4	TR 91/A	TP 98	TP 99	4,076	1	-
16662705	16662705N		5	TR 91/A	TP 98	TP 99	4,880	1	-
16662706	16662706N		6	TR 91/A	TP 98	TP 99	5,674	1	-
16662707	16662707N		7	TR 91/A	TP 98	TP 99	6,448	1	-
16662708	16662708N		8	TR 91/A	TP 98	TP 99	7,272	1	-
16662709	16662709N		9	TR 91/A	TP 98	TP 99	8,066	1	-
16662710	16662710N		10	TR 91/A	TP 98	TP 99	8,900	1	-
16662711	16662711N		11	TR 91/A	TP 98	TP 99	9,674	1	-
16662712	16662712N		12	TR 91/A	TP 98	TP 99	10,448	1	-



Raccordi per tubo rame



Raccordi per tubo plastica



Raccordi per tubo multistrato



Raccordi: capitolo 7



Accessori: capitolo 2.A



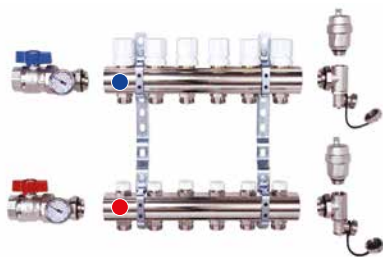



COLLETTORI DI DISTRIBUZIONE PREMONTATI CON ACCESSORI DI INSTALLAZIONE









Collettore di distribuzione premontato composto da:

- 1 collettore di ritorno con valvole incorporate predisposte per la regolazione elettrotermica e con volantino di comando manuale
- 1 collettore di andata con detentori incorporati predisposto per la doppia regolazione.

CD 465M

COD.	MISURA	N. VIE						
15552402MN	G 1" x (W24x19)	2	TR 91	TP 95	TP 97	4,172	1	-
15552403MN		3	TR 91	TP 95	TP 97	4,794	1	-
15552404MN		4	TR 91	TP 95	TP 97	5,416	1	-
15552405MN		5	TR 91	TP 95	TP 97	6,038	1	-
15552406MN		6	TR 91	TP 95	TP 97	6,660	1	-
15552407MN		7	TR 91	TP 95	TP 97	7,282	1	-
15552408MN		8	TR 91	TP 95	TP 97	7,904	1	-
15552409MN		9	TR 91	TP 95	TP 97	8,526	1	-
15552410MN		10	TR 91	TP 95	TP 97	9,148	1	-
15552411MN		11	TR 91	TP 95	TP 97	9,770	1	-
15552412MN		12	TR 91	TP 95	TP 97	10,392	1	-
15552413MN		13	TR 91	TP 95	TP 97	11,014	1	-

CD 468M

COD.	MISURA	N. VIE						
15552702MN	G 1" x G 3/4 EK	2	TR 91/A	TP 98	TP 99	4,212	1	-
15552703MN		3	TR 91/A	TP 98	TP 99	4,854	1	-
15552704MN		4	TR 91/A	TP 98	TP 99	5,496	1	-
15552705MN		5	TR 91/A	TP 98	TP 99	6,138	1	-
15552706MN		6	TR 91/A	TP 98	TP 99	6,780	1	-
15552707MN		7	TR 91/A	TP 98	TP 99	7,422	1	-
15552708MN		8	TR 91/A	TP 98	TP 99	8,064	1	-
15552709MN		9	TR 91/A	TP 98	TP 99	8,706	1	-
15552710MN		10	TR 91/A	TP 98	TP 99	9,348	1	-
15552711MN		11	TR 91/A	TP 98	TP 99	9,990	1	-
15552712MN		12	TR 91/A	TP 98	TP 99	10,632	1	-
15552713MN		13	TR 91/A	TP 98	TP 99	11,274	1	-

















Collettore di distribuzione premontato composto da:

- 1 collettore di ritorno con valvole incorporate predisposte per la regolazione elettrotermica e con volantino di comando manuale
- 1 collettore di andata con regolatori e misuratori di portata.

CD 478M

COD.	MISURA	N. VIE						
15652402MN	G 1" x (W24x19)	2	TR 91	TP 95	TP 97	3,904	1	-
15652403MN		3	TR 91	TP 95	TP 97	4,540	1	-
15652404MN		4	TR 91	TP 95	TP 97	5,186	1	-
15652405MN		5	TR 91	TP 95	TP 97	5,872	1	-
15652406MN		6	TR 91	TP 95	TP 97	6,498	1	-
15652407MN		7	TR 91	TP 95	TP 97	7,144	1	-
15652408MN		8	TR 91	TP 95	TP 97	7,800	1	-
15652409MN		9	TR 91	TP 95	TP 97	8,436	1	-
15652410MN		10	TR 91	TP 95	TP 97	9,082	1	-
15652411MN		11	TR 91	TP 95	TP 97	9,728	1	-
15652412MN		12	TR 91	TP 95	TP 97	10,354	1	-
15652413MN		13	TR 91	TP 95	TP 97	10,98	1	-

CD 473M

COD.	MISURA	N. VIE						
15652702MN	G 1" x G 3/4 EK	2	TR 91/A	TP 98	TP 99	3,934	1	-
15652703MN		3	TR 91/A	TP 98	TP 99	4,585	1	-
15652704MN		4	TR 91/A	TP 98	TP 99	5,246	1	-
15652705MN		5	TR 91/A	TP 98	TP 99	5,947	1	-
15652706MN		6	TR 91/A	TP 98	TP 99	6,588	1	-
15652707MN		7	TR 91/A	TP 98	TP 99	7,249	1	-
15652708MN		8	TR 91/A	TP 98	TP 99	7,920	1	-
15652709MN		9	TR 91/A	TP 98	TP 99	8,571	1	-
15652710MN		10	TR 91/A	TP 98	TP 99	9,232	1	-
15652711MN		11	TR 91/A	TP 98	TP 99	9,893	1	-
15652712MN		12	TR 91/A	TP 98	TP 99	10,534	1	-
15652713MN		13	TR 91/A	TP 98	TP 99	11,175	1	-



Raccordi per tubo rame



Raccordi per tubo plastica



Raccordi per tubo multistrato



Raccordi: capitolo 7



Accessori: capitolo 2.A

DIAGRAMMA DI PORTATA COLLETTORI
COLLETTORI DI DISTRIBUZIONE CON ATTACCO G 1/2 F

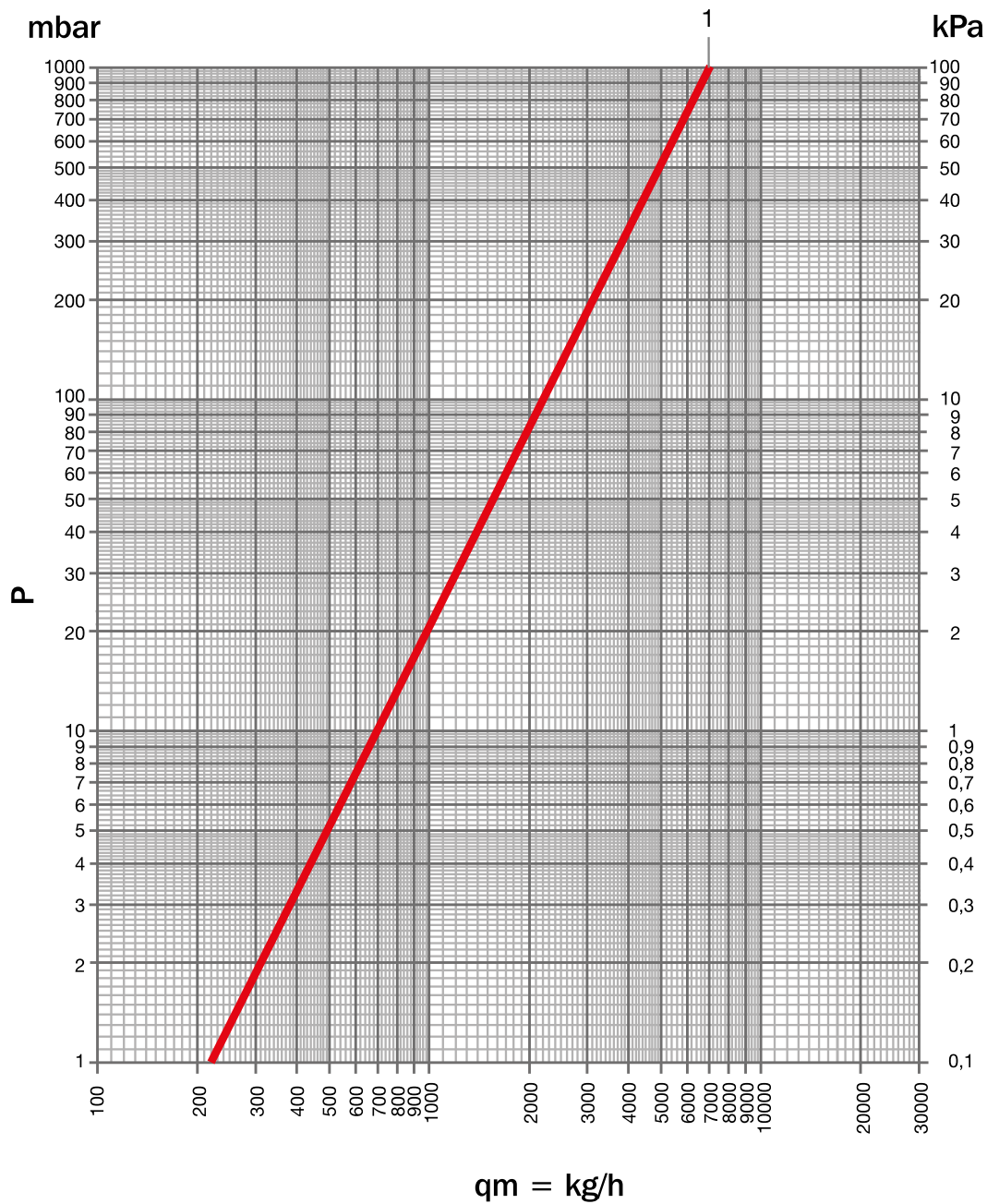

ARTICOLI	MISURA	FORO DI SCARICO	Kvs	POS
CD 451	G 3/4	NO	7.00	1
CD 456	G 1"			
CD 860	G 1 1/4			
CD 457	G 1"	SI	7.00	1
CD 861	G 1 1/4			

MAX PORTATA CONSIGLIATA	
G 3/4	2250 l/h
G 1"	3900 l/h
G 1 1/4	6600 l/h



DIAGRAMMA DI PORTATA COLLETTORI

COLLETTORI DI DISTRIBUZIONE CON ATTACCO PREMONTATO RD 900

 $q_m = \text{kg/h}$

ARTICOLI	MISURA	FORO DI SCARICO	Kvs	POS
CD 459	G 1"	NO	5.1	1
CD 461				
CD 862	G 1 1/4			
CD 864				
CD 460	G 1"	SI	5.1	1
CD 462				
CD 863	G 1 1/4			
CD 865				

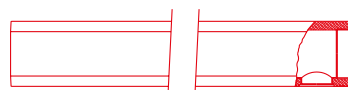
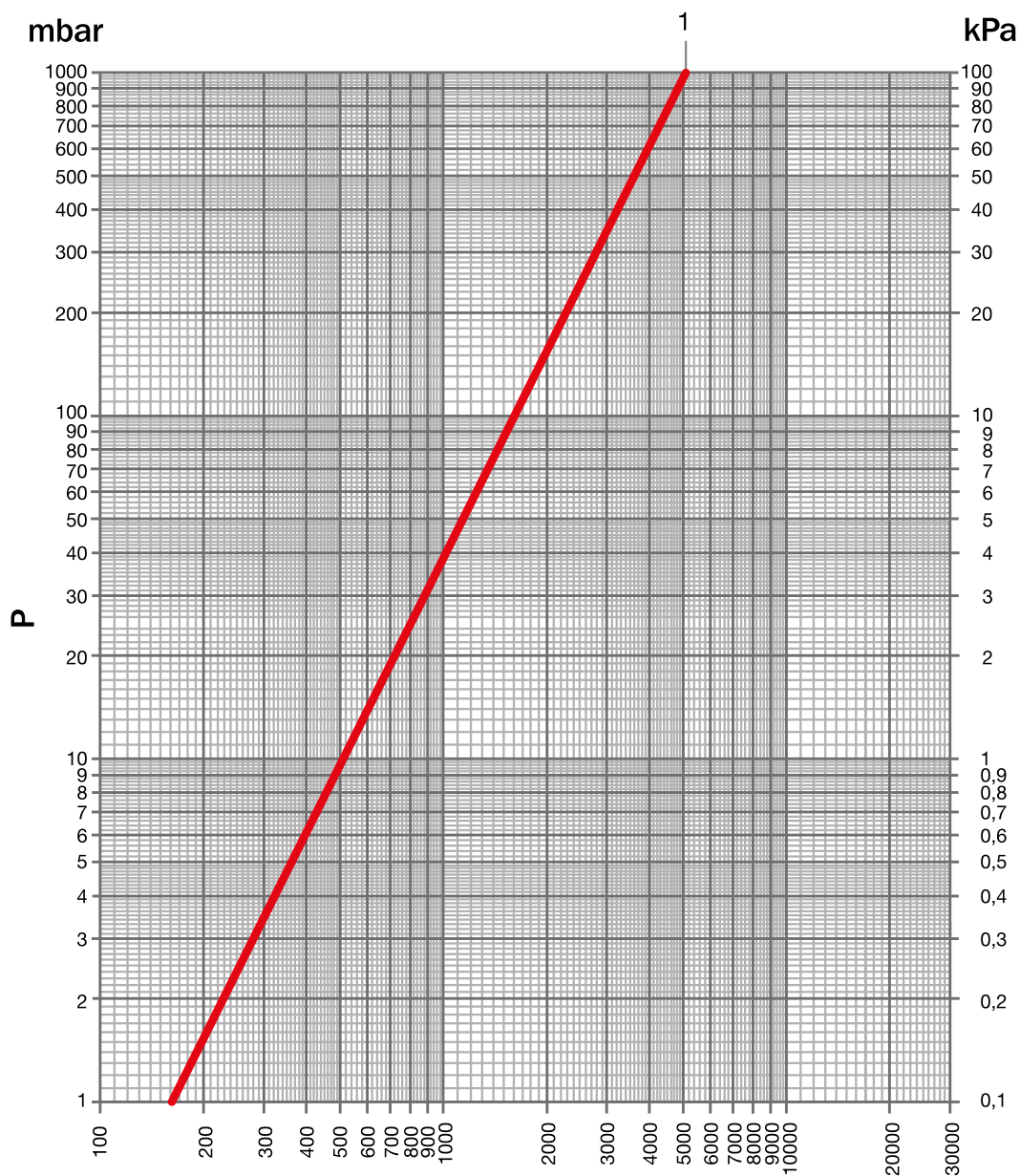
MAX PORTATA CONSIGLIATA	
G 1"	3900 l/h
G 1 1/4	6600 l/h



DIAGRAMMA DI PORTATA COLLETTORI

COLLETORE DI DISTRIBUZIONE PREMONTATO CON VITONE MANUALE

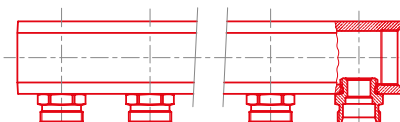
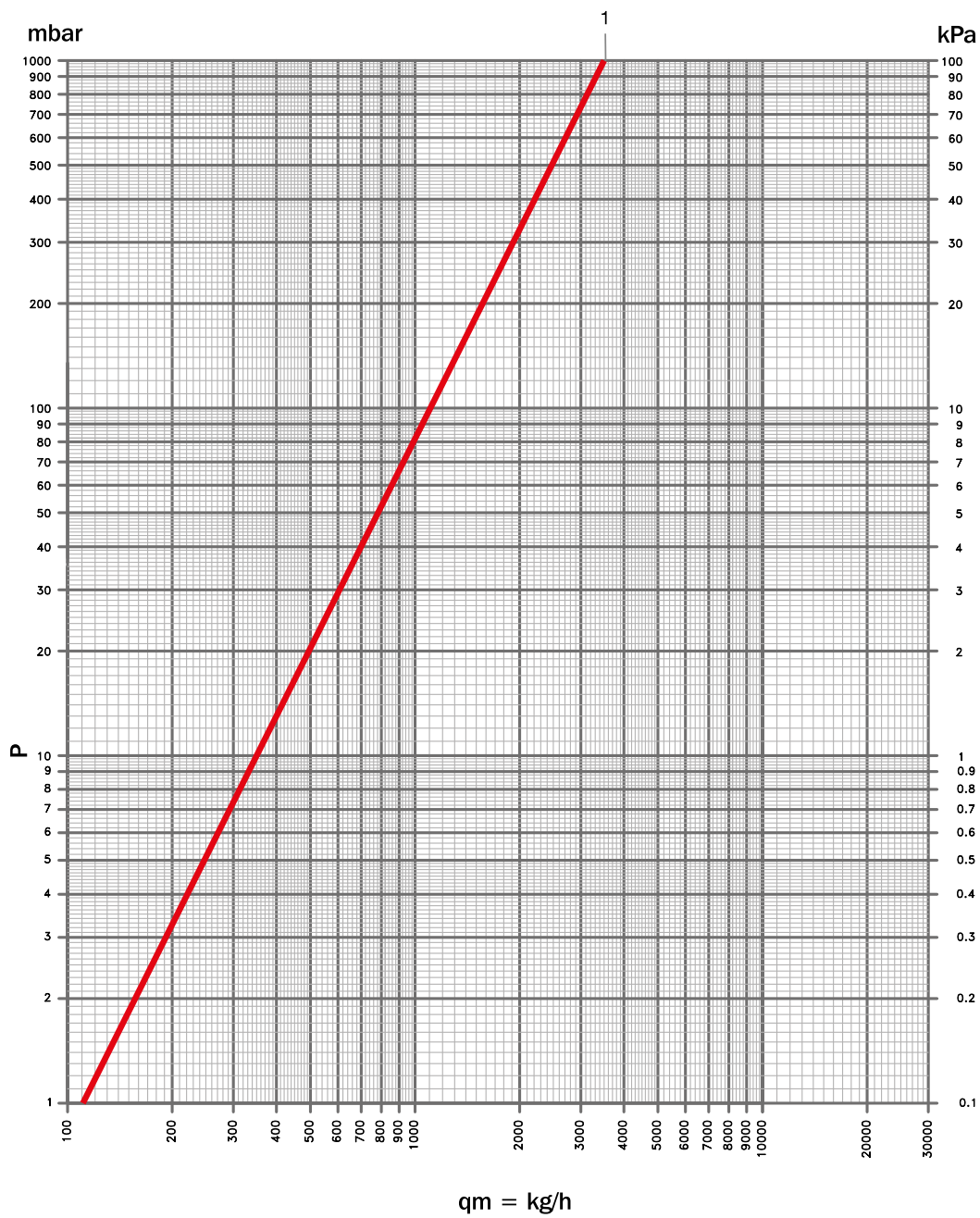

ARTICOLI	MISURA	Kvs	POS
CD 100	G 1"	3.5	1
CD 101			

MAX PORTATA CONSIGLIATA	
G 1"	3900 l/h



DIAGRAMMA DI PORTATA COLLETTORI

COLLETTORI DI DISTRIBUZIONE PREMONTATO CON VALVOLE INCORPORATE

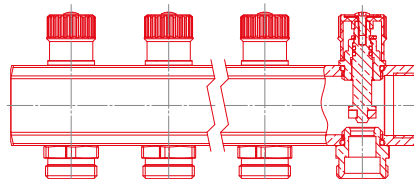
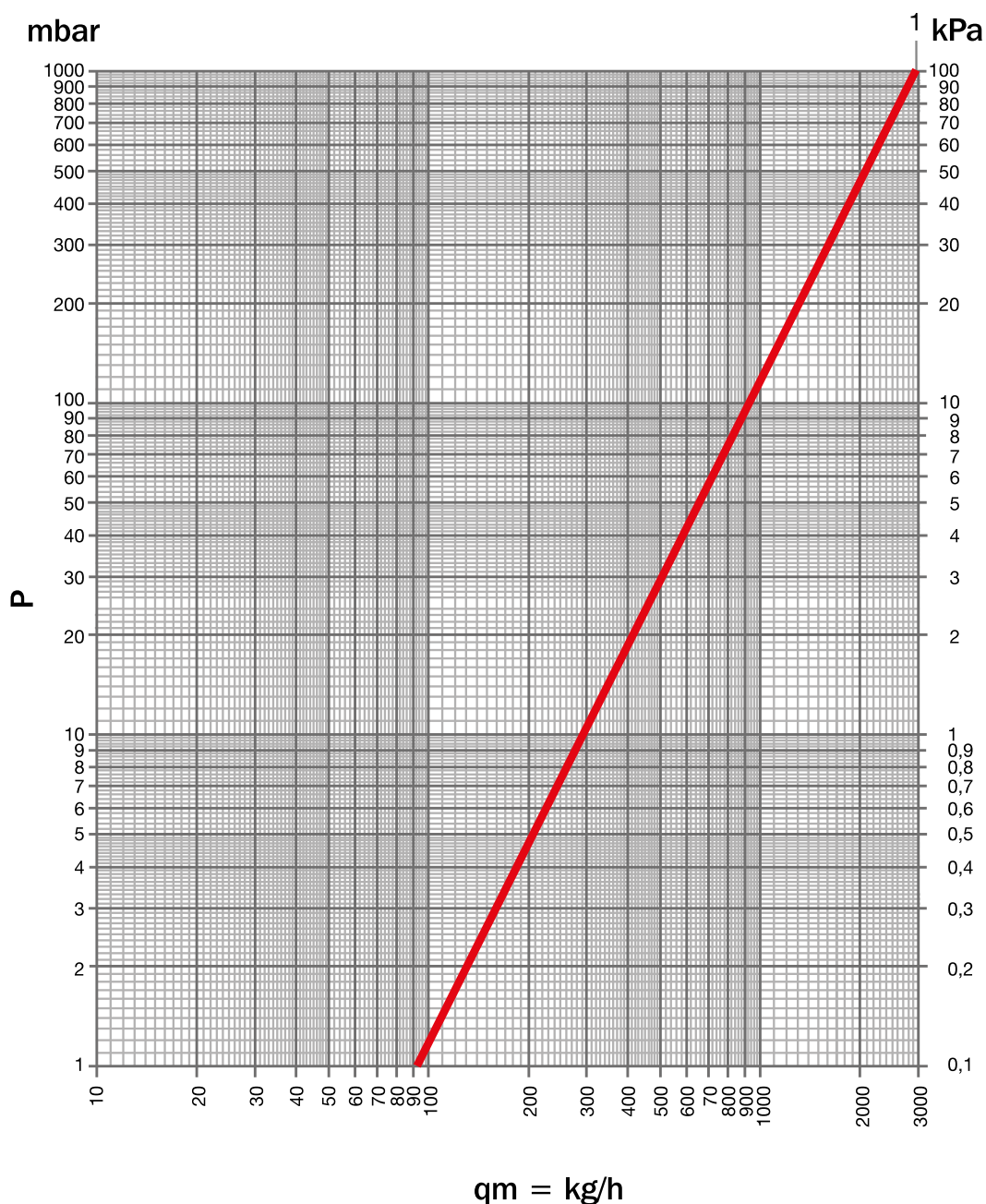

ARTICOLI	MISURA	FORO DI SCARICO	Kvs	POS
CD 1466 CD 466 CD 1446 CD 446	G 1"	NO	2.98	1
CD 875 CD 871 CD 876 CD 872	G 1"1/4			
CD 3466 CD 2466 CD 3446 CD 2446	G 1"	SI		
CD 877 CD 873 CD 878 CD 874	G 1"1/4			

MAX PORTATA CONSIGLIATA	
G 1"	3900 l/h
G 1"1/4	6600 l/h



DIAGRAMMA DI PORTATA COLLETTORI
COLLETTORI DI DISTRIBUZIONE CON DETENTORI



qm = kg/h

ARTICOLI	MISURA	N. GIRI	FORO DI SCARICO	Kvs	POS
CD 449	G 1"	1/2	NO	0,09	1
CD 448	G 1"	1		0,27	2
CD 879	G 1"1/4	1+1/2		0,76	3
		2		0,98	4
CD 880	G 1"1/4	2+1/2		1,20	5
		3	1,46	6	
CD 1449	G 1"	3+1/2	SI	1,70	7
CD 1448	G 1"	4		1,93	8
		4+1/2		2,19	9
CD 881	G 1"1/4	5		2,47	10
		5+1/2		2,75	11
CD 882	G 1"1/4	tutto aperto		3,01	12

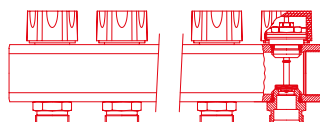
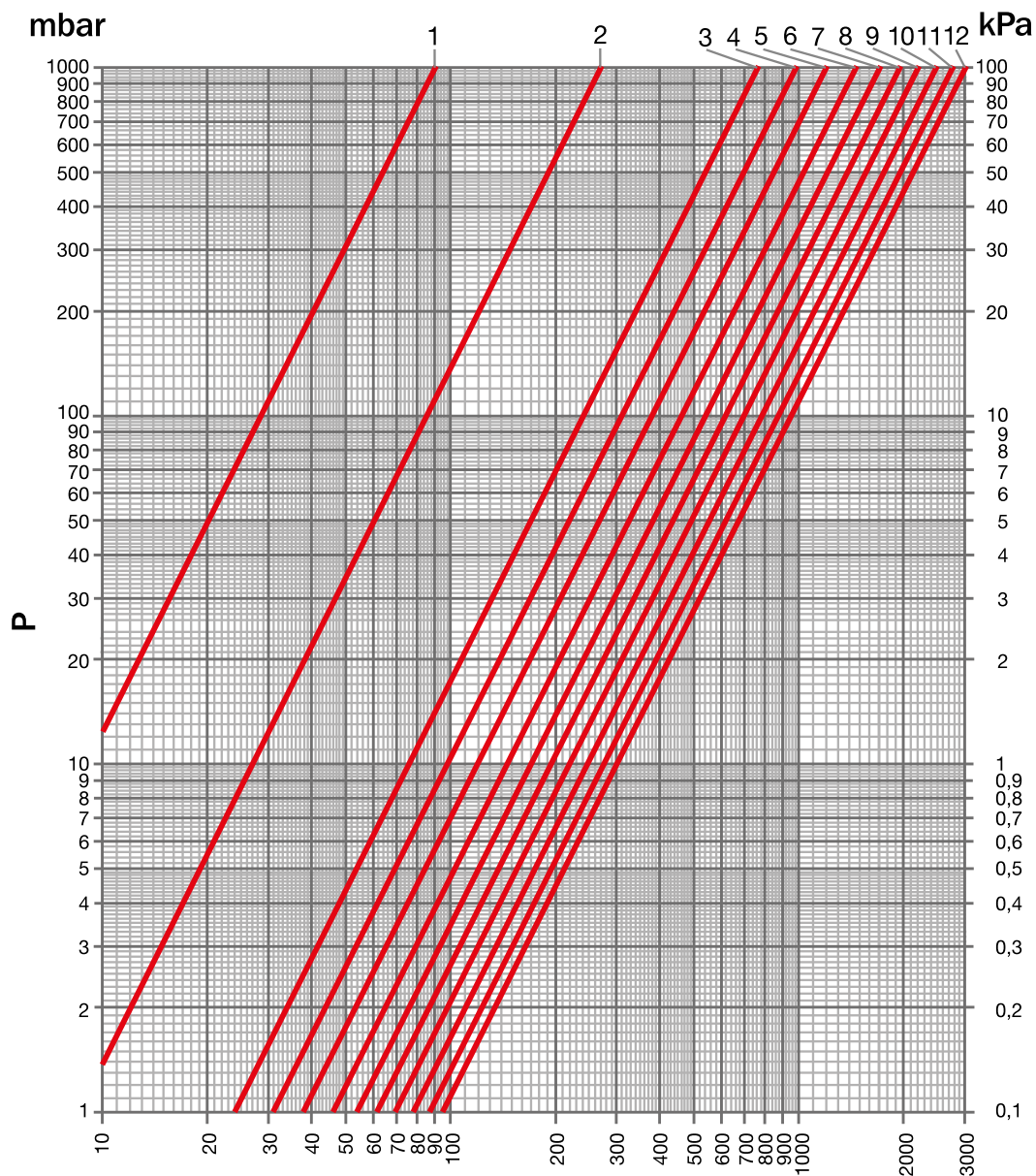
MAX PORTATA CONSIGLIATA	
G 1"	2400 l/h
G 1"1/4	4200 l/h



DIAGRAMMA DI PORTATA COLLETTORI

COLLETTORI DI DISTRIBUZIONE CON REGOLATORI DI PORTATA TM

 $q_m = \text{kg/h}$

ARTICOLI	MISURA	CD + TM	FORO DI SCARICO	Kvs	POS
CD 1474	G 1"	TM 4012	NO	1,05	1
CD 474	G 1"				
CD 868	G 1 1/4		SI		
CD 867	G 1 1/4				
CD 3474	G 1"				
CD 2474	G 1"				
CD 870	G 1 1/4				
CD 869	G 1 1/4				

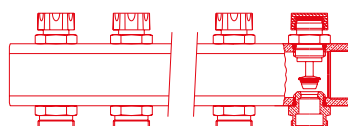
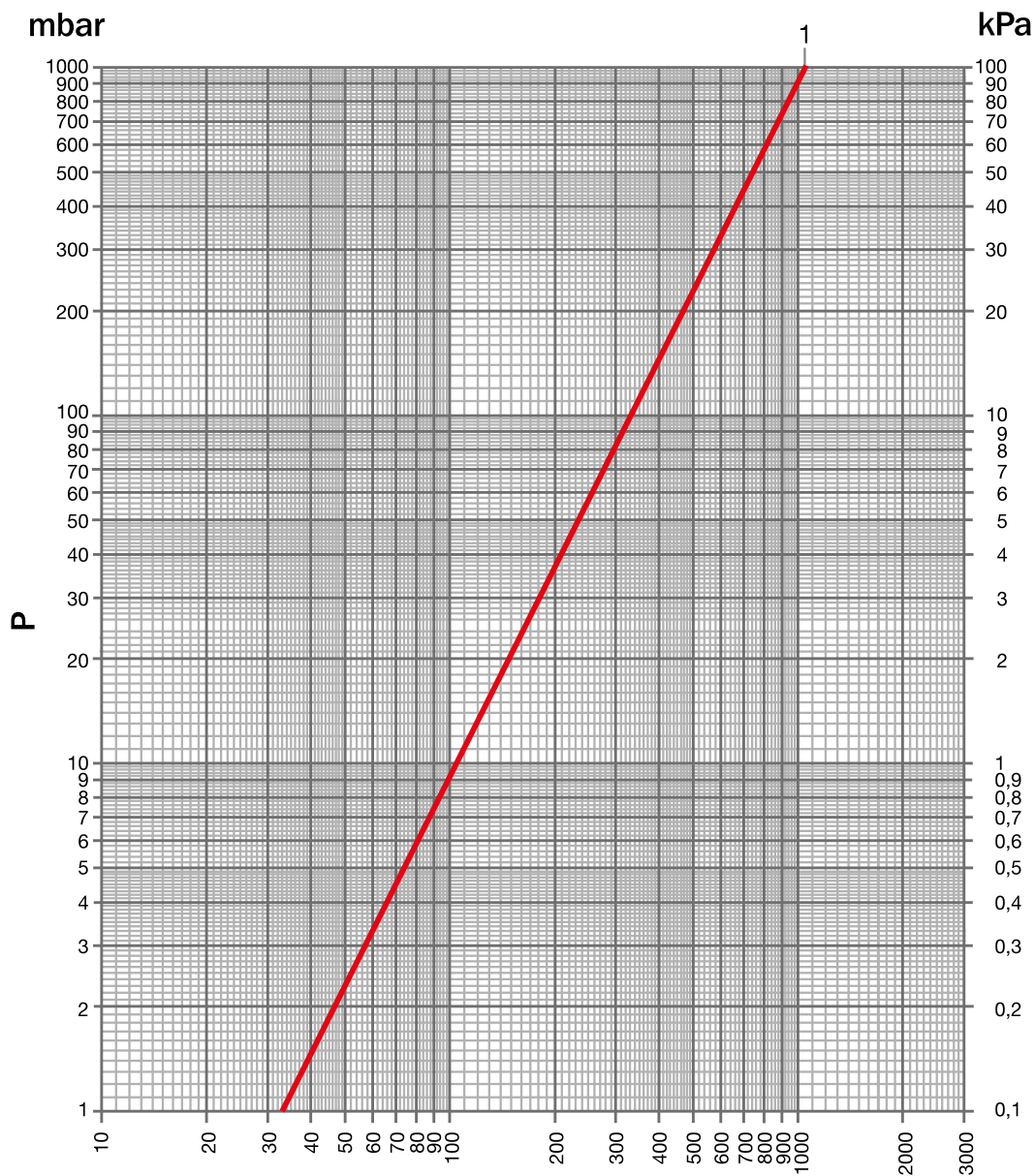
MAX PORTATA CONSIGLIATA	
G 1"	1350 l/h
G 1 1/4	3150 l/h



DIAGRAMMA DI PORTATA COLLETTORI

COLLETTORI DI DISTRIBUZIONE CON DETENTORI INCORPORATI

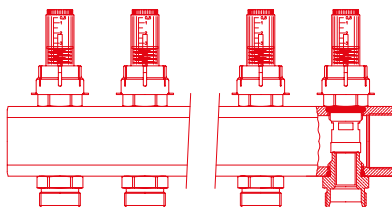
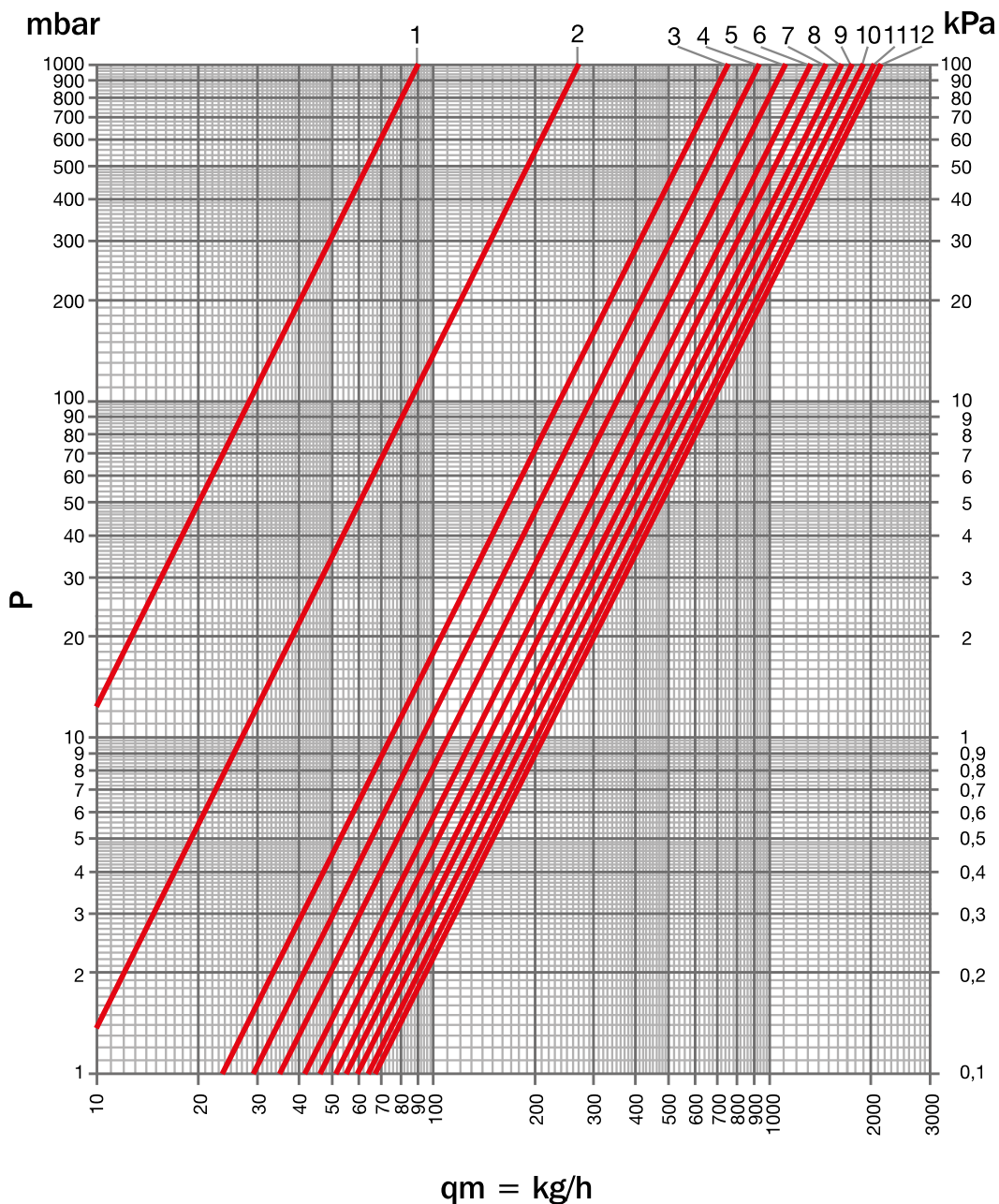

ARTICOLI	MISURA	N. GIRI	FORO DI SCARICO	Kvs	POS
CD 2465 - CD 2468	G 1"	1/2	NO	0,09	1
CD 2865 - CD 2868	G 1"1/4	1		0,27	2
		1+1/2		0,75	3
CD 2467 - CD 2469	G 1"	2	SI	0,93	4
CD 2867 - CD 2869	G 1"1/4	2+1/2		1,11	5
		3	1,31	6	
CD 465 - CD 468	G 1"	3+1/2	NO	1,48	7
CD 1865 - CD 1868	G 1"1/4	4		1,62	8
		4+1/2	1,76	9	
CD 467 - CD 469	G 1"	5	SI	1,90	10
CD 1867 - CD 1869	G 1"1/4	5+1/2		2,02	11
		tutto aperto	2,12	12	

MAX PORTATA CONSIGLIATA	
G 1"	2400 l/h
G 1"1/4	4200 l/h



DIAGRAMMA DI PORTATA COLLETTORI

COLLETTORI DI DISTRIBUZIONE CON REGOLATORI DI PORTATA TM

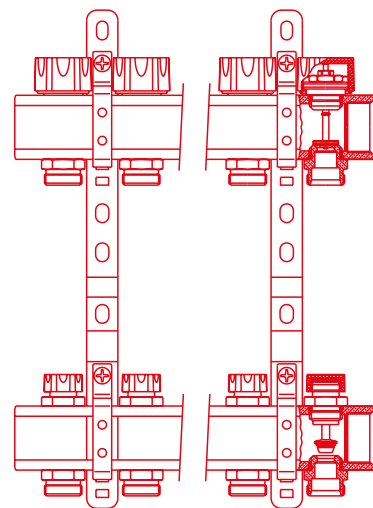
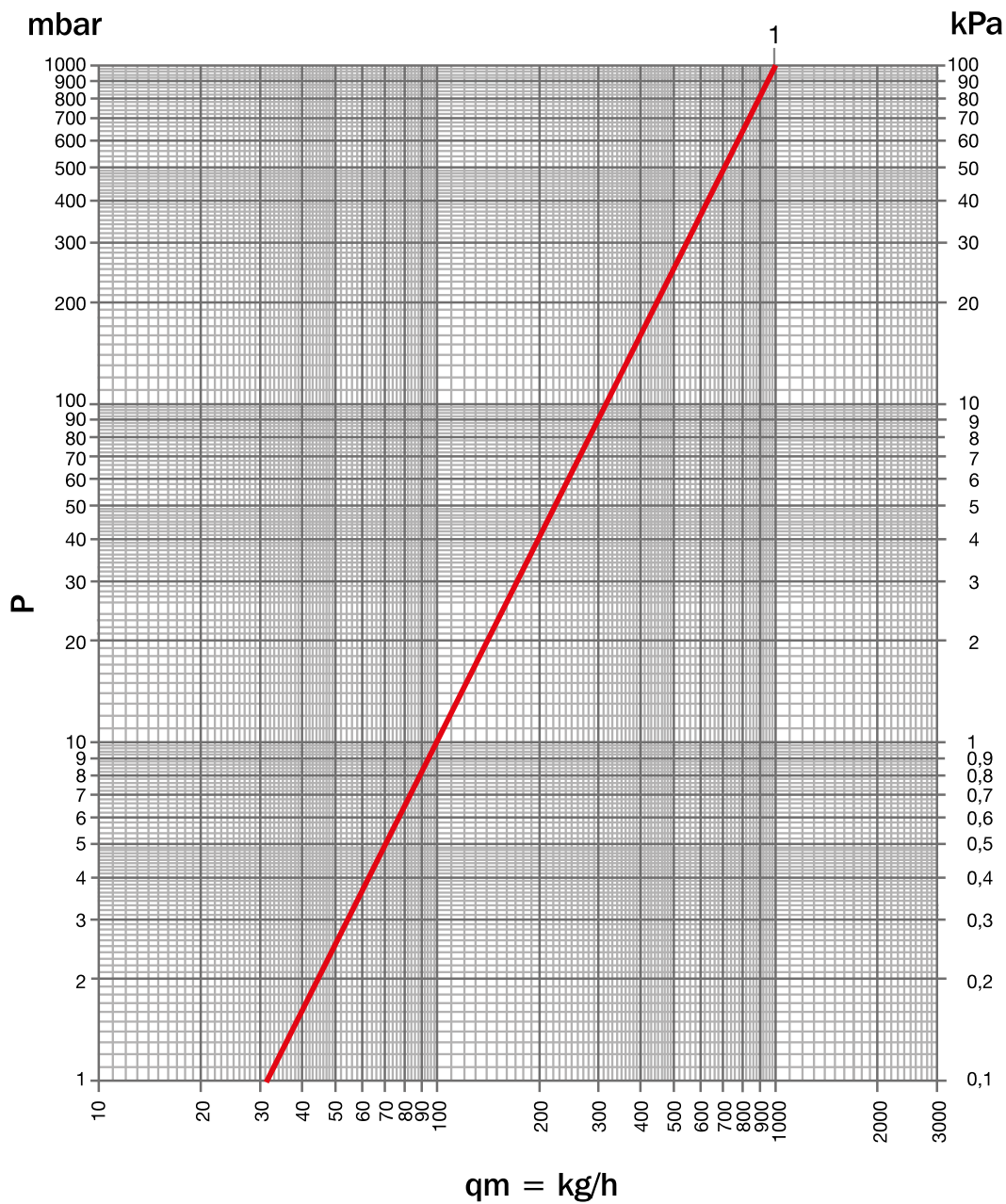

ARTICOLI	MISURA	CD + TM	FORO DI SCARICO	Kvs	POS
CD 2478 - CD 2473	G 1"	TM 4012	NO	0,99	1
CD 2878 - CD 2873	G 1"1/4				
CD 2479 - CD 2477	G 1"		SI		
CD 2879 - CD 2877	G 1"1/4				
CD 478 - CD 473	G 1"		NO		
CD 1878 - CD 1873	G 1"1/4				
CD 479 - CD 477	G 1"		SI		
CD 1879 - CD 1877	G 1"1/4				

MAX PORTATA CONSIGLIATA	
G 1"	1350 l/h
G 1"1/4	3150 l/h

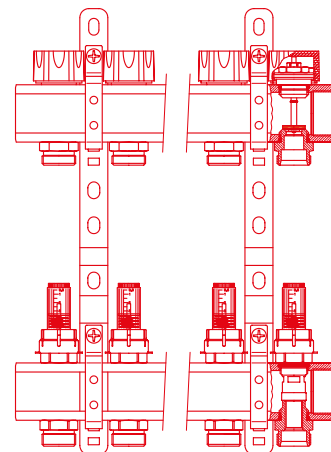



A series of horizontal lines for writing, spaced evenly down the page.



COLLETTORI DI DISTRIBUZIONE IN ACCIAIO INOX

2.4 / SERIE CX

CX

COLLETTORI DI DISTRIBUZIONE IN ACCIAIO INOX

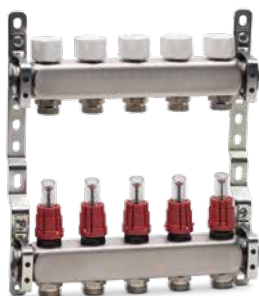

Sui collettori di nostra produzione utilizzare solo accessori Luxor che abbiano una tenuta morbida con guarnizione. Tutta la raccorderia e gli accessori dei collettori (valvole di scarico, terminali, tappi, ecc) sono dotati di tale tenuta e non necessitano di alcun elemento intermedio di sigillatura

(come ptfе, canapa, ecc) il cui utilizzo potrebbe causare l'insorgere di cricche.

Si consiglia di serrare la raccorderia ad una coppia massima di 60 Nm.

CARATTERISTICHE TECNICHE

Max temperatura	Max pressione	Materiale	Manopola	Asta di comando	Collaudo
120 °C	10 bar	AISI 304	ABS bianco RAL 9016	AISI 316	100%

ATTACCHI IMPIANTO



Tubo rame
W 24x19 - TR 91
G 3/4 EK - TR 91/A

CARATTERISTICHE TECNICHE CON REGOLATORI MISURATORI DI PORTATA ART. TM 4014

Max temperatura	Max pressione	Temperatura fluido	Temperatura ambiente	Max umidità relativa
65 °C	6 bar	0 °C ÷ 100 °C	0 °C ÷ 60 °C	80%

CARATTERISTICHE TECNICHE CON TESTE TERMoeLETRICHE ART. TE



Tubo plastica
W 24x19 - TP 95
G 3/4 EK - TP 98

ATTACCO CORPO PRINCIPALE



G 1"

INTERASSI



G 1" 50 mm



Tubo multistrato
W 24x19 - TP 97
G 3/4 EK - TP 99

REGOLATORI E MISURATORI DI PORTATA



I collettori di regolazione e bilanciamento, con regolatori e misuratori di portata TM 4014, danno la possibilità di una immediata verifica del bilanciamento dell'impianto attraverso la lettura della portata. La regolazione può essere bloccata tramite un coperchio d'arresto. Il bicchiere e la molla di misurazione possono essere smontati e puliti con l'impianto in funzione. Questo collettore deve essere installato sulla mandata.

DETTENTORI



I collettori di regolazione e bilanciamento (tipo detentore) sono dotati di regolazione micrometrica e predisposti per la memoria di posizione nel caso di chiusura momentanea e possono essere montati indifferentemente sia sulle mandate sia sui ritorni dei circuiti.



VITONE TERMOSTATIZZABILE

L'organo di tenuta sullo stelo dei collettori con valvole incorporate predisposte per la regolazione elettrotermica è ispezionabile e sostituibile anche con impianto in funzione. L'asta di comando è in acciaio inossidabile AISI 316 con una tenuta garantita da due guarnizioni o-ring in EPDM perossidico.

Tutti i collettori serie CX vengono testati al 100% con prova di tenuta pneumatica a controllo elettronico.

Le caratteristiche del fluido dell'impianto devono essere conformi alla direttiva UNI 8065:2019.

COLLETTORI DI DISTRIBUZIONE PER RISCALDAMENTO CON REGOLATORI E MISURATORI DI PORTATA IN MANDATA

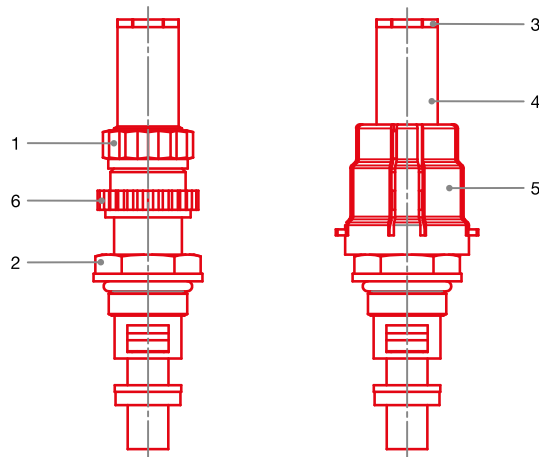

1. Ghiera di regolazione
2. Ghiera di fissaggio
3. Ghiera del bicchiere
4. Bicchiere
5. Coperchio d'arresto
6. Ghiera di memoria

ISTRUZIONI DI REGOLAZIONE COLLETTORI CON REGOLATORI MISURATORI DI PORTATA IN MANDATA

BILANCIAMENTO DEI CIRCUITI IDRAULICI

Il valore della portata teorica di un circuito idraulico, stabilito dal tecnico, è determinato dalla regolazione effettuata tramite i regolatori e misuratori di portata TM 4014 cod. 69000018 posizionati sulla mandata del circuito.

La regolazione deve avvenire con la valvola posta sul ritorno completamente aperta.

Dato che le portate di ciascun anello si influenzano tra loro, è importante che le regolazioni siano effettuate per ogni anello fino all'effettivo raggiungimento dei valori di portata in l/min stabiliti dal progetto.

FUNZIONE "MEMORY -STOP" FLUSSIMETRO

Sistema di bloccaggio del grado di apertura del flussimetro che consente, alla riapertura del circuito, l'arresto della corsa nella impostazione iniziale (valore di progetto).

- 1) Impostare la regolazione del Flussimetro a valore di progetto. Il volantino, durante questa operazione, deve essere tolto;
- 2) Avvitare la ghiera di "Memory-Stop" in senso antiorario (filettatura sinistra) fino ad arrivare a fine corsa;
- 3) Riposizionare il volantino. Agendo sul volantino (ruotando in senso orario) è possibile chiudere il singolo circuito. Ruotando in senso contrario fino al suo bloccaggio, è possibile riaprire il circuito, fino a valore di progetto impostato.

FLUSSIMETRO TM 4014 0,5 L

ΔP Pa	ΔP Kpa	Q l/h
10	0,01	8
100	0,1	25
500	0,5	60
1000	1	82
5000	5	185
10000	10	260
20000	20	365
30000	30	450
40000	40	520
50000	50	585
60000	60	640
70000	70	690
80000	80	740
90000	90	785
100000	100	825

Tramite le due asole presenti sul volantino è possibile piombare il Flussimetro, onde evitarne la manomissione della regolazione impostata.

Attenzione: NON utilizzare attrezzi per la manovra/regolazione del Flussimetro, onde pregiudicarne il corretto funzionamento del Flussimetro stesso.

PULIZIA

Il bicchiere e la molla di misurazione possono essere smontati per la manutenzione e puliti anche con l'impianto in funzione. Per effettuare l'operazione:

- chiudere il Top meter e il vitone posto sul collettore di ritorno
- svitare il bicchiere facendo forza sulla ghiera dello stesso e toglierlo. Attenzione a non perdere la molla di misurazione
- risulterà una leggera, ma trascurabile, perdita durante l'operazione
- il bicchiere ora può essere, se necessario, pulito senza difficoltà
- il rimontaggio si effettua invertendo le operazioni.

PERDITE DI CARICO

La perdita di carico totale per circuito di riscaldamento si compone di varie perdite di carico: valvola di ritorno, tubi e regolatore misuratore di portata.

CARATTERISTICHE FLUIDODINAMICHE

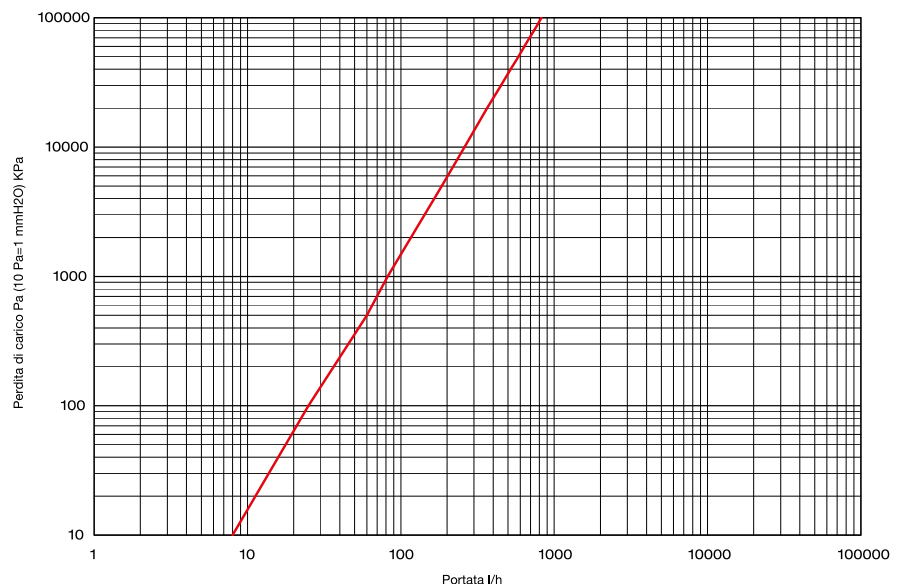

COLLETTORI DI DISTRIBUZIONE PER RISCALDAMENTO CON DETENTORI INCORPORATI

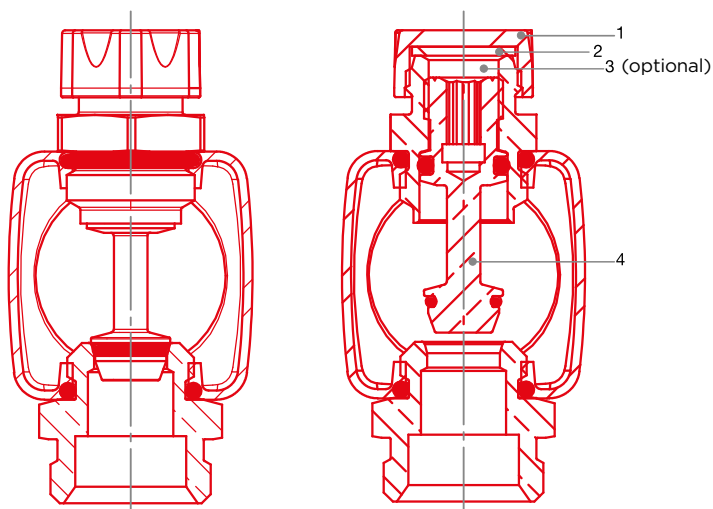

1. Tappo in ABS

2. Guarnizione di tenuta

3. Ghiera di regolazione cod. 3346656

4. Otturatore

ISTRUZIONI DI REGOLAZIONE DEI COLLETTORI CON DETENTORI

Svitare il tappo (1). Con la chiave a brugola avvitare l'otturatore fino a raggiungere la posizione di chiusura.

Dopo queste operazioni, il detentore è pronto per essere settato.

Sul diagramma di pressione differenziale è descritta la relazione tra valore di Kv, la posizione dell'otturatore e la corrispondente curva. Questo significa che, se si svita l'otturatore di un determinato numero di giri, si otterrà il Kv desiderato.

ESEMPIO

- Curva n. 1: 1/2 giri della vite - Kv = 0,09

- Curva n. 3: 1+1/2 giri della vite - Kv = 0,76

Utilizzando la ghiera (fornita a parte) cod. 3346656 è possibile creare un fine corsa meccanico all'otturatore.

Una volta impostata la portata desiderata tramite l'otturatore, la ghiera di regolazione deve essere avvitata in battuta contro l'otturatore.

Ora è possibile chiudere e riaprire l'otturatore senza perdere la posizione di regolazione impostata precedentemente.

In caso di perdite o trafiletti di acqua dall'asta del vitone termostattizzabile, si può agire serrando l'assemblato di tenuta fino alla cessazione della stessa. Se la perdita non dovesse terminare, si può sostituire il completo assemblato di tenuta del vitone con il gruppo in funzione eseguendo le operazioni sotto elencate.

- Togliere il cappuccio di protezione o il volantino manuale, o la testa termostatica o la testa termoelettrica;
- Svitare l'assemblato di tenuta con una chiave 9 mm bloccando il corpo vitone con una chiave da 19 mm;
- Sostituire l'assemblato di tenuta con l'accessorio di ricambio cod.: 67980200 avvitandolo con una chiave 9 mm;
- Riposizionare il cappuccio di protezione o il volantino manuale o la testa termostatica o la testa termoelettrica.

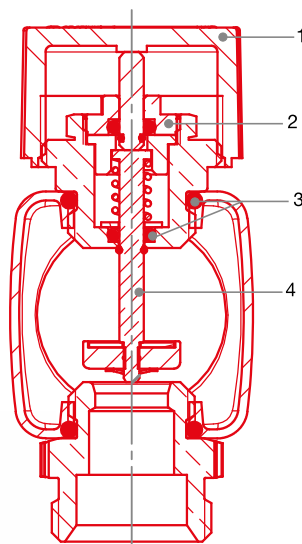

1. Tappo o volantino manuale in ABS

2. Assemblato di tenuta art.516

3. Guarnizione di tenuta

4. Otturatore

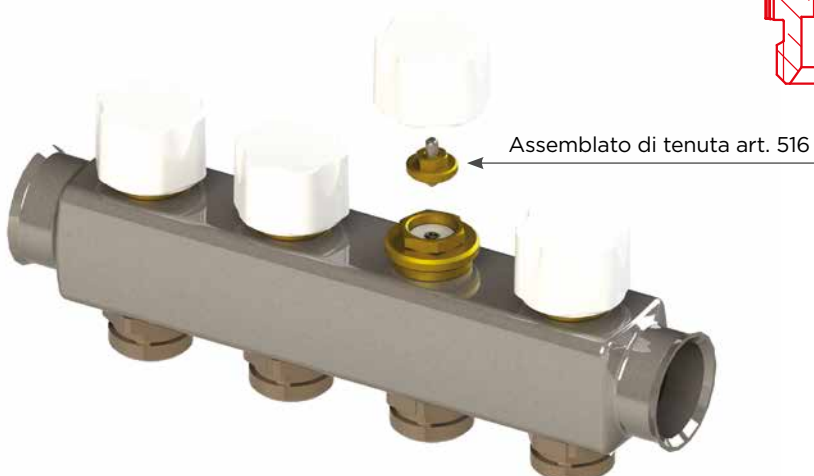

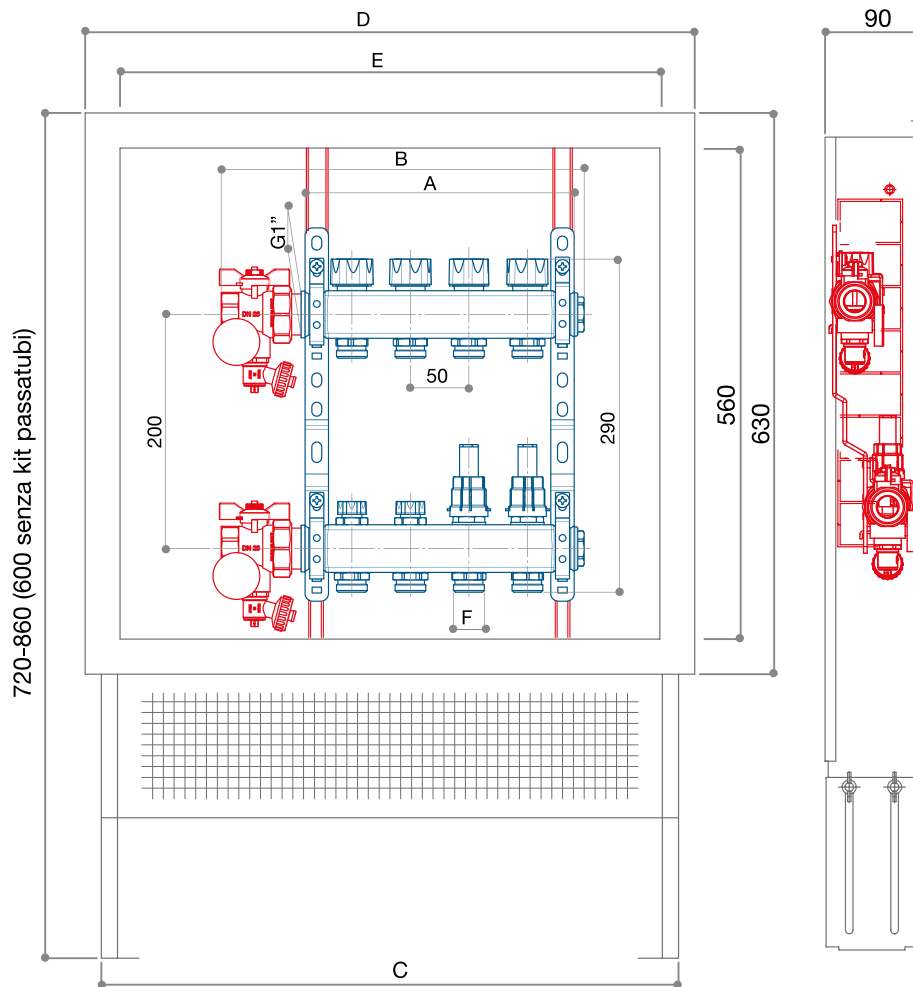
G 1"**SCHEMA PER SELEZIONARE LA CASSETTA CORRETTA****COLLETTORI DA G 1"**

							CASSETTE	
VIE	A	B	C	D	E	F	ART.	COD.
2	130	210						
3	180	260						
4	230	310	500	560	490		CF 490	68561405
5	280	360						
6	330	410						
7	380	460						
8	430	510	700	760	690	W24x19 - G 3/4 EK	CF 490	68561407
9	480	560						
10	530	610						
11	580	660						
12	630	710	850	910	840		CF 490	68561408
13	680	760						
14	730	810						
15	780	860	1000	1060	990		CF 490	68561410
16	830	910						

COLLETTORI DI DISTRIBUZIONE IN ACCIAIO INOX

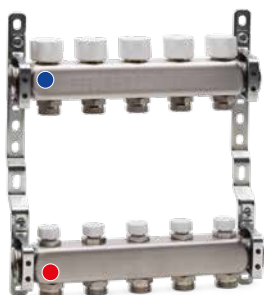

Collettore di distribuzione composto da:

- 1 collettore di ritorno con valvole incorporate predisposte per la regolazione elettrotermica e con cappucci di protezione
- 1 collettore di andata con detentori incorporati predisposto per la doppia regolazione
- 2 supporti metallici.

CX 2465

COD.	MISURA	N. VIE						
15512402X	G 1" x (W24x19)	2	TR 91	TP 95	TP 97	1,331	1	-
15512403X		3	TR 91	TP 95	TP 97	1,756	1	-
15512404X		4	TR 91	TP 95	TP 97	2,166	1	-
15512405X		5	TR 91	TP 95	TP 97	2,552	1	-
15512406X		6	TR 91	TP 95	TP 97	2,998	1	-
15512407X		7	TR 91	TP 95	TP 97	3,384	1	-
15512408X		8	TR 91	TP 95	TP 97	3,782	1	-
15512409X		9	TR 91	TP 95	TP 97	4,108	1	-
15512410X		10	TR 91	TP 95	TP 97	4,602	1	-
15512411X		11	TR 91	TP 95	TP 97	5,008	1	-
15512412X		12	TR 91	TP 95	TP 97	5,438	1	-
15512413X		13	TR 91	TP 95	TP 97	5,832	1	-
15512414X		14	TR 91	TP 95	TP 97	5,914	1	-
15512415X		15	TR 91	TP 95	TP 97	6,303	1	-
15512416X		16	TR 91	TP 95	TP 97	6,692	1	-

CX 2468

COD.	MISURA	N. VIE						
15512702X	G 1" x G 3/4 EK	2	TR 91/A	TP 98	TP 99	1,138	1	-
15512703X		3	TR 91/A	TP 98	TP 99	1,756	1	-
15512704X		4	TR 91/A	TP 98	TP 99	2,166	1	-
15512705X		5	TR 91/A	TP 98	TP 99	2,552	1	-
15512706X		6	TR 91/A	TP 98	TP 99	2,998	1	-
15512707X		7	TR 91/A	TP 98	TP 99	3,384	1	-
15512708X		8	TR 91/A	TP 98	TP 99	3,782	1	-
15512709X		9	TR 91/A	TP 98	TP 99	4,108	1	-
15512710X		10	TR 91/A	TP 98	TP 99	4,602	1	-
15512711X		11	TR 91/A	TP 98	TP 99	5,008	1	-
15512712X		12	TR 91/A	TP 98	TP 99	5,438	1	-
15512713X		13	TR 91/A	TP 98	TP 99	5,832	1	-
15512714X		14	TR 91/A	TP 98	TP 99	6,306	1	-
15512715X		15	TR 91/A	TP 98	TP 99	6,723	1	-
15512716X		16	TR 91/A	TP 98	TP 99	7,140	1	-



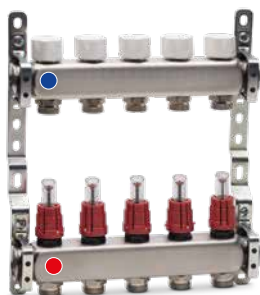

Collettore di distribuzione premontato composto da:

- 1 collettore di ritorno con valvole incorporate predisposte per la regolazione elettrotermica e con cappucci di protezione
- 1 collettore di andata con regolatori misuratori di portata
- 2 supporti metallici.

CX 2478

COD.	MISURA	N. VIE						
15612402X	G 1" x (W24x19)	2	TR 91	TP 95	TP 97	1,276	1	-
15612403X		3	TR 91	TP 95	TP 97	1,666	1	-
15612404X		4	TR 91	TP 95	TP 97	2,040	1	-
15612405X		5	TR 91	TP 95	TP 97	2,412	1	-
15612406X		6	TR 91	TP 95	TP 97	2,804	1	-
15612407X		7	TR 91	TP 95	TP 97	3,160	1	-
15612408X		8	TR 91	TP 95	TP 97	3,528	1	-
15612409X		9	TR 91	TP 95	TP 97	3,856	1	-
15612410X		10	TR 91	TP 95	TP 97	4,280	1	-
15612411X		11	TR 91	TP 95	TP 97	4,652	1	-
15612412X		12	TR 91	TP 95	TP 97	5,042	1	-
15612413X		13	TR 91	TP 95	TP 97	5,424	1	-
15612414X		14	TR 91	TP 95	TP 97	5,525	1	-
15612415X		15	TR 91	TP 95	TP 97	5,886	1	-
15612416X		16	TR 91	TP 95	TP 97	6,247	1	-

CX 2473

COD.	MISURA	N. VIE						
15612702X	G 1" x G 3/4 EK	2	TR 91/A	TP 98	TP 99	1,082	1	-
15612703X		3	TR 91/A	TP 98	TP 99	1,666	1	-
15612704X		4	TR 91/A	TP 98	TP 99	2,040	1	-
15612705X		5	TR 91/A	TP 98	TP 99	2,412	1	-
15612706X		6	TR 91/A	TP 98	TP 99	2,804	1	-
15612707X		7	TR 91/A	TP 98	TP 99	3,160	1	-
15612708X		8	TR 91/A	TP 98	TP 99	3,528	1	-
15612709X		9	TR 91/A	TP 98	TP 99	3,856	1	-
15612710X		10	TR 91/A	TP 98	TP 99	4,280	1	-
15612711X		11	TR 91/A	TP 98	TP 99	4,652	1	-
15612712X		12	TR 91/A	TP 98	TP 99	5,042	1	-
15612713X		13	TR 91/A	TP 98	TP 99	5,424	1	-
15612714X		14	TR 91/A	TP 98	TP 99	5,917	1	-
15612715X		15	TR 91/A	TP 98	TP 99	6,306	1	-
15612716X		16	TR 91/A	TP 98	TP 99	6,695	1	-



Raccordi per tubo rame



Raccordi per tubo plastica



Raccordi per tubo multistrato



Raccordi: capitolo 7



Accessori: capitolo 2.A

COLLETTORI DI DISTRIBUZIONE IN ACCIAIO INOX PREMONTATI CON ACCESSORI DI INSTALLAZIONE

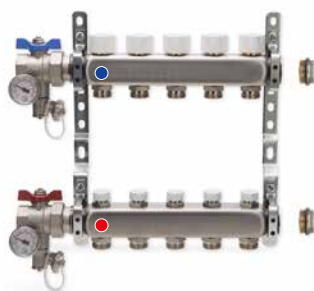

Collettore di distribuzione premontato composto da:

- 1 collettore di ritorno con valvole incorporate predisposte per la regolazione elettrotermica e con volantino di comando manuale
- 1 collettore di andata con detentori incorporati predisposto per la doppia regolazione.

CX 2465M

COD.	MISURA	N. VIE						
15512402MX	G 1" x (W24x19)	2	TR 91	TP 95	TP 97	2,658	1	-
15512403MX		3	TR 91	TP 95	TP 97	3,276	1	-
15512404MX		4	TR 91	TP 95	TP 97	3,686	1	-
15512405MX		5	TR 91	TP 95	TP 97	4,072	1	-
15512406MX		6	TR 91	TP 95	TP 97	4,518	1	-
15512407MX		7	TR 91	TP 95	TP 97	4,904	1	-
15512408MX		8	TR 91	TP 95	TP 97	5,302	1	-
15512409MX		9	TR 91	TP 95	TP 97	5,628	1	-
15512410MX		10	TR 91	TP 95	TP 97	6,122	1	-
15512411MX		11	TR 91	TP 95	TP 97	6,528	1	-
15512412MX		12	TR 91	TP 95	TP 97	6,958	1	-
15512413MX		13	TR 91	TP 95	TP 97	7,352	1	-
15512414MX		14	TR 91	TP 95	TP 97	7,313	1	-
15512415MX		15	TR 91	TP 95	TP 97	7,702	1	-
15512416MX		16	TR 91	TP 95	TP 97	8,090	1	-

CX 2468M

COD.	MISURA	N. VIE						
15512702MX	G 1" x G 3/4 EK	2	TR 91/A	TP 98	TP 99	2,658	1	-
15512703MX		3	TR 91/A	TP 98	TP 99	3,276	1	-
15512704MX		4	TR 91/A	TP 98	TP 99	3,686	1	-
15512705MX		5	TR 91/A	TP 98	TP 99	4,072	1	-
15512706MX		6	TR 91/A	TP 98	TP 99	4,518	1	-
15512707MX		7	TR 91/A	TP 98	TP 99	4,904	1	-
15512708MX		8	TR 91/A	TP 98	TP 99	5,302	1	-
15512709MX		9	TR 91/A	TP 98	TP 99	5,628	1	-
15512710MX		10	TR 91/A	TP 98	TP 99	6,122	1	-
15512711MX		11	TR 91/A	TP 98	TP 99	6,528	1	-
15512712MX		12	TR 91/A	TP 98	TP 99	6,958	1	-
15512713MX		13	TR 91/A	TP 98	TP 99	7,352	1	-
15512714MX		14	TR 91/A	TP 98	TP 99	7,705	1	-
15512715MX		15	TR 91/A	TP 98	TP 99	8,122	1	-
15512716 MX		16	TR 91/A	TP 98	TP 99	8,538	1	-



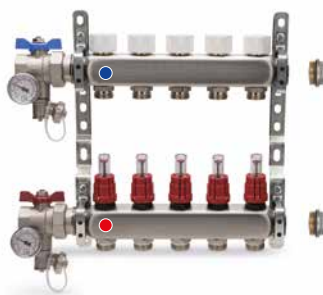

Collettore di distribuzione premontato composto da:

- 1 collettore di ritorno con valvole incorporate predisposte per la regolazione elettrotermica e con volantino di comando manuale
- 1 collettore di andata con regolatori e misuratori di portata.

CX 2478M

COD.	MISURA	N. VIE						
15612402MX	G 1" x (W24x19)	2	TR 91	TP 95	TP 97	2,602	1	-
15612403MX		3	TR 91	TP 95	TP 97	3,186	1	-
15612404MX		4	TR 91	TP 95	TP 97	3,560	1	-
15612405MX		5	TR 91	TP 95	TP 97	3,932	1	-
15612406MX		6	TR 91	TP 95	TP 97	4,324	1	-
15612407MX		7	TR 91	TP 95	TP 97	4,680	1	-
15612408MX		8	TR 91	TP 95	TP 97	5,048	1	-
15612409MX		9	TR 91	TP 95	TP 97	5,376	1	-
15612410MX		10	TR 91	TP 95	TP 97	5,800	1	-
15612411MX		11	TR 91	TP 95	TP 97	6,172	1	-
15612412MX		12	TR 91	TP 95	TP 97	6,562	1	-
15612413MX		13	TR 91	TP 95	TP 97	6,944	1	-
15612414MX		14	TR 91	TP 95	TP 97	6,924	1	-
15612415MX		15	TR 91	TP 95	TP 97	7,285	1	-
15612416MX		16	TR 91	TP 95	TP 97	7,646	1	-

CX 2473M

COD.	MISURA	N. VIE						
15612702MX	G 1" x G 3/4 EK	2	TR 91/A	TP 98	TP 99	2,602	1	-
15612703MX		3	TR 91/A	TP 98	TP 99	3,186	1	-
15612704MX		4	TR 91/A	TP 98	TP 99	3,560	1	-
15612705MX		5	TR 91/A	TP 98	TP 99	3,932	1	-
15612706MX		6	TR 91/A	TP 98	TP 99	4,324	1	-
15612707MX		7	TR 91/A	TP 98	TP 99	4,680	1	-
15612708MX		8	TR 91/A	TP 98	TP 99	5,048	1	-
15612709MX		9	TR 91/A	TP 98	TP 99	5,376	1	-
15612710MX		10	TR 91/A	TP 98	TP 99	5,800	1	-
15612711MX		11	TR 91/A	TP 98	TP 99	6,172	1	-
15612712MX		12	TR 91/A	TP 98	TP 99	6,562	1	-
15612713MX		13	TR 91/A	TP 98	TP 99	6,944	1	-
15612714MX		14	TR 91/A	TP 98	TP 99	7,316	1	-
15612715MX		15	TR 91/A	TP 98	TP 99	7,705	1	-
15612716MX		16	TR 91/A	TP 98	TP 99	8,094	1	-



Raccordi per tubo rame



Raccordi per tubo plastica



Raccordi per tubo multistrato



Raccordi: capitolo 7



Accessori: capitolo 2.A

VALVOLA A SFERA MULTIFUNZIONE



CARATTERISTICHE TECNICHE



Max temperatura

90°C



Max pressione

10 bar



DN

25



Materiale

CW617N

CARATTERISTICHE COSTRUTTIVE

Le valvole a sfera multifunzione vengono prodotte in ottone CW617N e sono compatibili con i collettori e con gli altri componenti prodotti da Luxor.

Le valvole a sfera multifunzione hanno il perno di manovra montato dall'interno. Questo sistema è chiamato "antiscoppio" perché offre maggiori garanzie contro la fuoriuscita accidentale del perno e del relativo sistema di tenuta e per l'impossibilità di essere manomesso dall'esterno. Le valvole a sfera presentano una doppia tenuta con anelli O-Ring in elastomero, scelto per l'elevata resistenza all'invecchiamento.

FUNZIONALITÀ

Le valvole a sfera multifunzione sono estremamente compatte e si possono installare sia sulla destra sia sulla sinistra del collettore semplicemente posizionando il termometro sul lato desiderato.

Esse vengono definite "multifunzione" perché racchiudono in un unico prodotto una serie di funzionalità:

- **Valvola carico/scarico acqua:** nella parte inferiore della valvola è presente un valvolino girevole per il carico/scarico dell'acqua, manovrabile tramite la chiave quadrata ricavata nel tappo di chiusura.
- **Valvola sfiato aria manuale:** nell'asta della maniglia è presente uno sfiato manuale per l'aria che si può manovrare sempre tramite la chiave ricavata nel tappo della valvola di carico/scarico acqua. La posizione dello scarico presente nella parte superiore della valvola permette un ottimo funzionamento agevolando la fuoriuscita di tutta l'aria presente nell'impianto.
- **Termometro integrato** per la visualizzazione della temperatura: può essere posizionato su entrambi i lati in base all'utilizzo.

VALVOLA A SFERA



VALVOLA CARICO / SCARICO ACQUA

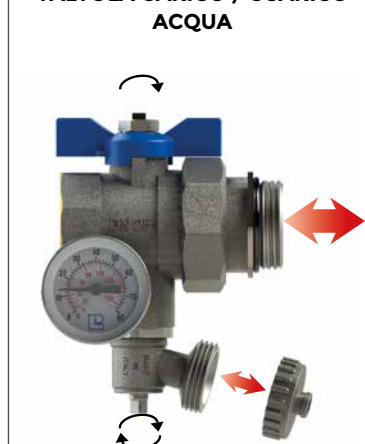

VALVOLA SCARICO ARIA MANUALE

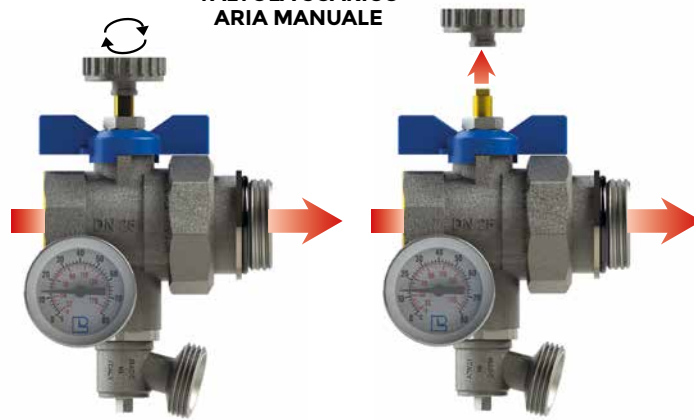

VALVOLE A SFERA MULTIFUNZIONE

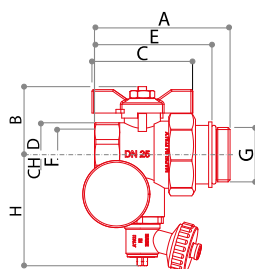
**VC 481**

Valvola a sfera multifunzione con scarico aria manuale, carico acqua, maniglia a farfalla di colore di colore blu o rosso e raccordo art. CR 498 con o-ring per attacco al collettore completa di termometro scala 0 °C ÷ 80 °C.

CODICE	MISURA	A	B	C	D	E	F	G	H	L			
68559722B	G 1"	81	41	60	38	70	G 1"	G 1"	70	-	645	4	32
68559722R	G 1"	81	41	60	38	70	G 1"	G 1"	70	-	645	4	32

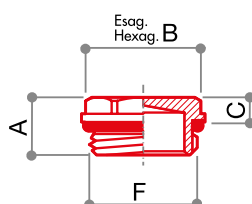
**TC 460**

Tappo cieco con guarnizione o-ring.

CODICE	MISURA	FINITURA	A	B	C	D	E	F	G	H	L			
68559934N	G 1"	NICHELATA	19	27	9	-	-	G 1"	-	-	-	52	50	400

DIAGRAMMA DI PORTATA COLLETTORI

COLLETTORI DI DISTRIBUZIONE CON DETENTORI INCORPORATI

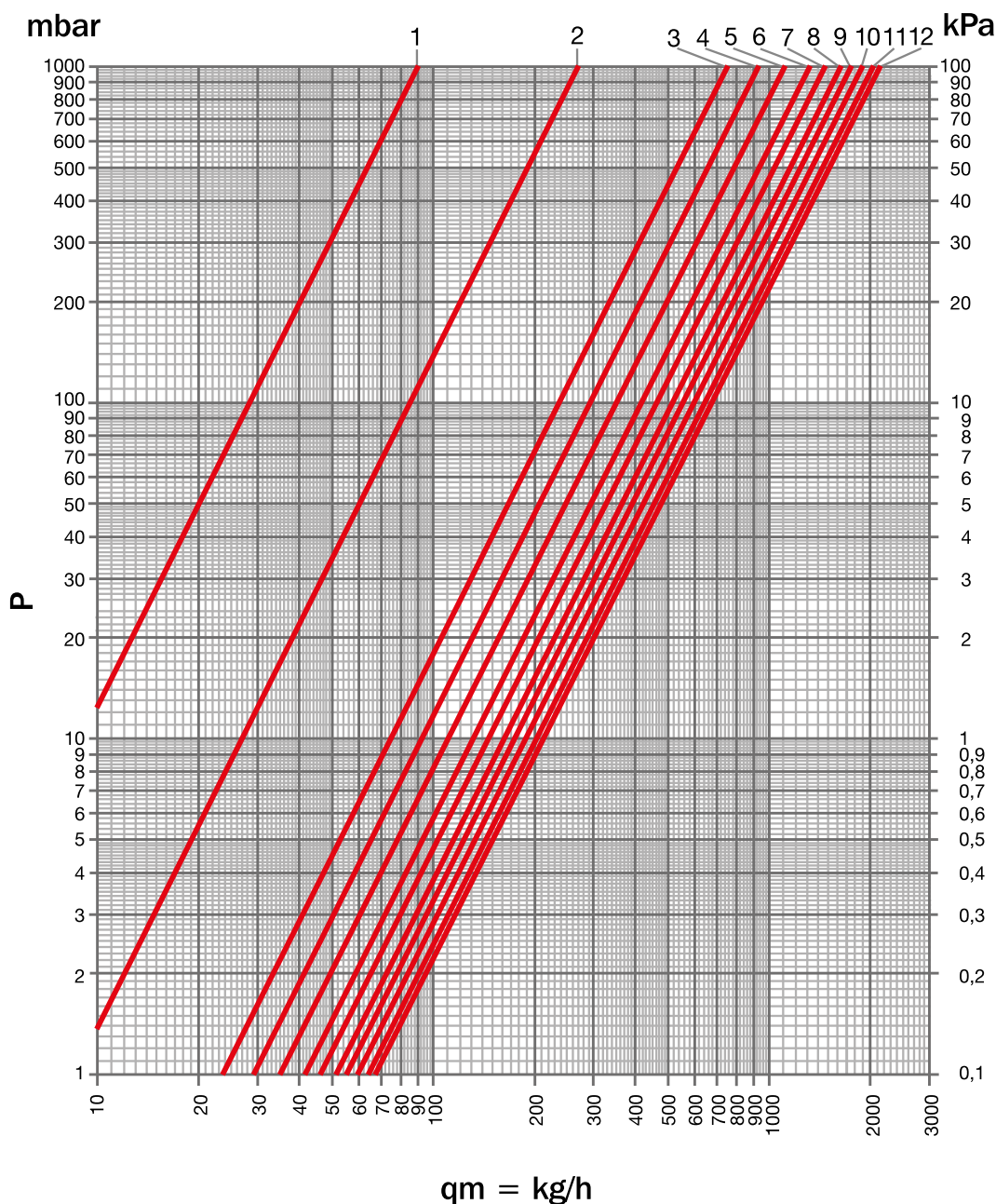

qm = kg/h

ARTICOLI	MISURA	N. GIRI	Kvs	POS
CX 2468	G 1"	1/2	0,09	1
		1	0,27	2
		1+1/2	0,75	3
		2	0,93	4
		2+1/2	1,11	5
		3	1,31	6
		3+1/2	1,48	7
		4	1,62	8
		4+1/2	1,76	9
		5	1,90	10
		5+1/2	2,02	11
		tutto aperto	2,12	12

MAX PORTATA CONSIGLIATA
2860 l/h



DIAGRAMMA DI PORTATA COLLETTORI

COLLETTORI DI DISTRIBUZIONE CON REGOLATORI DI PORTATA TM

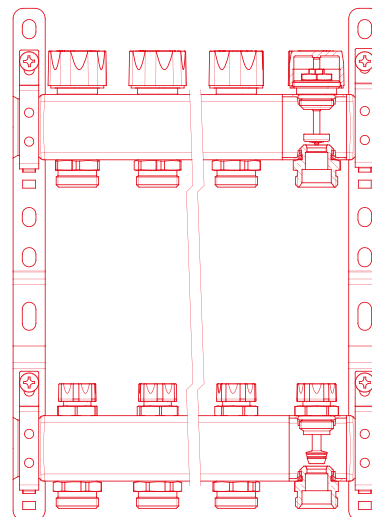
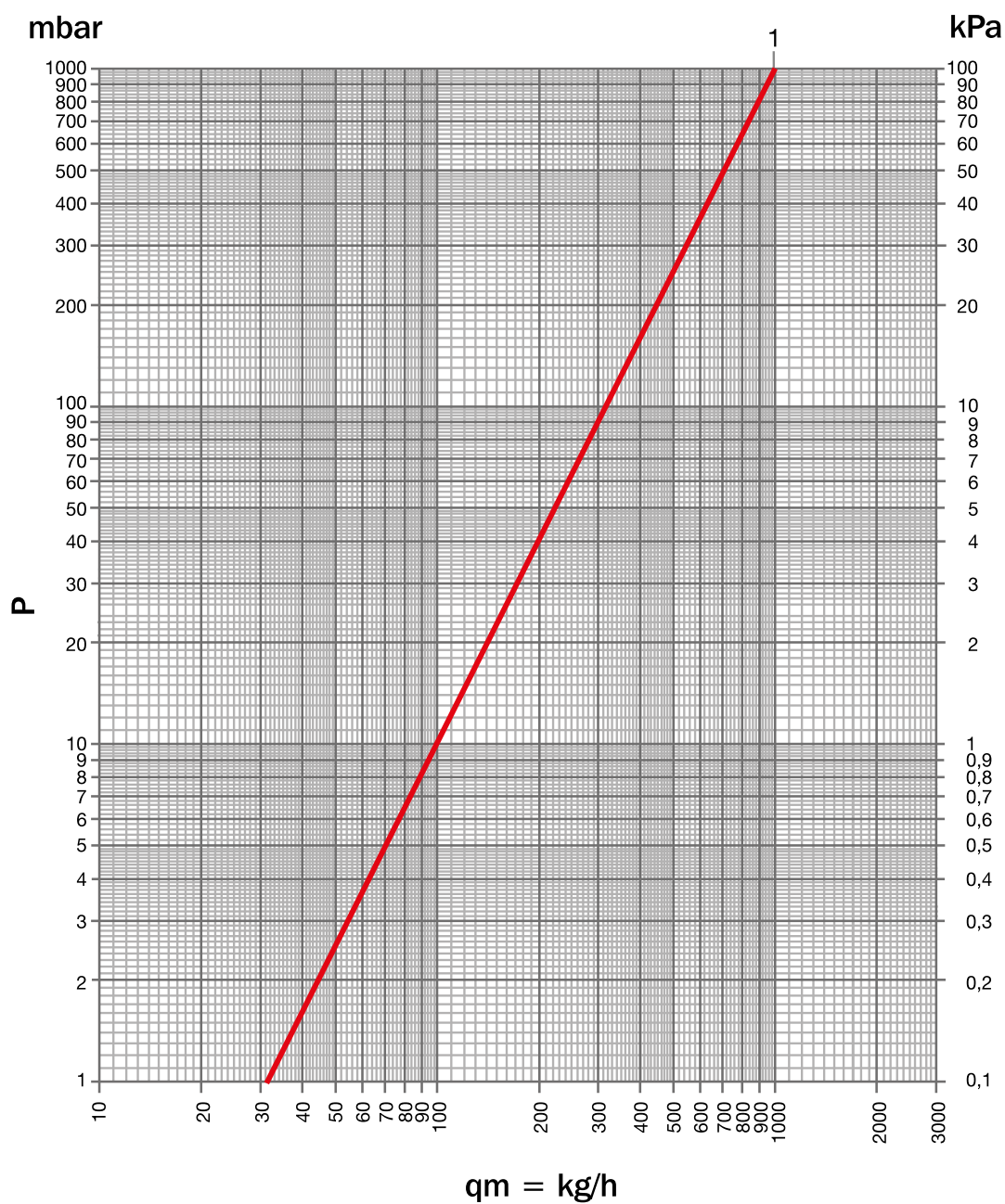

ARTICOLI	MISURA	CX + TM	Kvs	POS
CX 2473	G 1"	TM 4014	0,99	1

MAX PORTATA CONSIGLIATA
2450 l/h

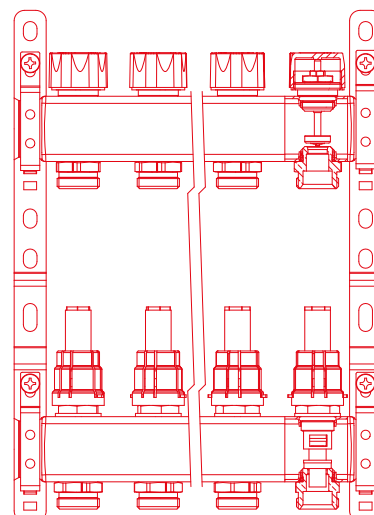



A series of horizontal lines spaced evenly down the page, creating a template for writing or notes.



LUXOR®

COLLETTORI

2.A / ACCESSORI

TESTE TERMOSTATICHE

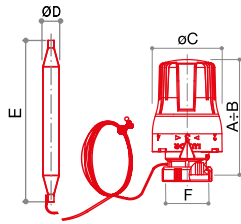

TT 3051

Testa termostatica per riscaldamento a pavimento con sonda a distanza. Campo di regolazione 20 °C+65 °C. Lunghezza standard del capillare trasmettitore 2 m.

CODICE	MISURA	aperto		chiuso		C	D	E	F	G	H	L	🔗	📦	📦
		A	B	A	B										
69100005	M30x1,5	80	75	47	11	110	M30x1,5	-	-	-	146	1	32		

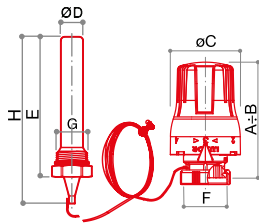

TT 3061

Testa termostatica per riscaldamento a pavimento con pozzetto da G1/2 M per sonda a distanza. Campo di regolazione 20° C+65° C. Lunghezza standard del capillare trasmettitore 2 m.

CODICE	MISURA	aperto		chiuso		C	D	E	F	G	H	L	🔗	📦	📦
		A	B	A	B										
69100006	M30x1,5	80	75	47	15	95	M30x1,5	G 1/2	110	-	232	1	32		

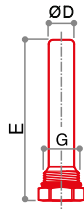

PS 540

Pozzetto per sonda.

CODICE	MISURA	A	B	C	D	E	F	G	H	L	🔗	📦	📦
9446950	G 1/2	-	-	-	15	95	-	G 1/2	-	-	92	20	160



DT 242

Dispositivo di fissaggio per sonda articolo TT 3051.

CODICE	MISURA	🔗	📦	📦
69010500	-	30	20	160

ACCESSORI PER COLLETTORI DI DISTRIBUZIONE

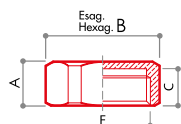
**TC 430**

Tappo di testa cieco con guarnizione in EPDM.



Conforme secondo il D.M. 174/2004

CODICE	MISURA	A	B	C	D	E	F	G	H	L			
68502701	G 3/4	13	30	11	-	-	G 3/4	-	-	-	37	100	800
68503401	G 1"	15	37	12	-	-	G 1"	-	-	-	60	50	400

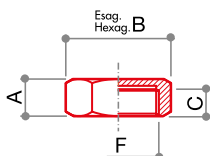
**TC 450**

Tappo laterale cieco con guarnizione piana di tenuta.

CODICE	MISURA	FINITURA	A	B	C	D	E	F	G	H	L			
68552419	(W24x19)	GIALLA	11	27	8	-	-	W24x19	-	-	-	25	100	800
68552419N	(W24x19)	NICHELATA	11	27	8	-	-	W24x19	-	-	-	25	100	800

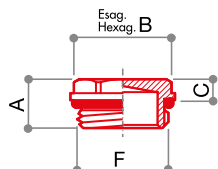
**TC 460**

Tappo cieco con guarnizione o-ring.

CODICE	MISURA	FINITURA	A	B	C	D	E	F	G	H	L			
68559917	G 3/8	GIALLA	13	20	8	-	-	G 3/8	-	-	-	20	200	1600
68559921	G 1/2	GIALLA	13	22	7	-	-	G 1/2	-	-	-	20	100	800
68559927	G 3/4	GIALLA	14	25	7	-	-	G 3/4	-	-	-	32	100	800
68559934	G 1"	GIALLA	19	27	9	-	-	G 1"	-	-	-	52	50	400
68559942	G 1" 1/4	GIALLA	25	38	12	-	-	G 1" 1/4	-	-	-	94	30	240
68559917N	G 3/8	NICHELATA	13	20	8	-	-	G 3/8	-	-	-	20	200	1600
68559921N	G 1/2	NICHELATA	13	22	7	-	-	G 1/2	-	-	-	20	100	800
68559927N	G 3/4	NICHELATA	14	25	7	-	-	G 3/4	-	-	-	32	100	800
68559934N	G 1"	NICHELATA	19	27	9	-	-	G 1"	-	-	-	52	50	400
68559942N	G 1" 1/4	NICHELATA	25	38	12	-	-	G 1" 1/4	-	-	-	94	30	240

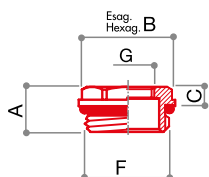
**TC 462**

Tappo con riduzione e con guarnizione di tenuta o-ring.

CODICE	MISURA	FINITURA	A	B	C	D	E	F	G	H	L			
68559901	G 3/4 x G 3/8	GIALLA	14	25	8	-	-	G 3/4	G 3/8	-	-	31	100	800
68559905	G 3/4 x G 1/2	GIALLA	14	25	8	-	-	G 3/4	G 1/2	-	-	23	100	800
68559902	G 1" x G 3/8	GIALLA	19	27	10	-	-	G 1"	G 3/8	-	-	60	50	400
68559903	G 1" x G 1/2	GIALLA	19	27	10	-	-	G 1"	G 1/2	-	-	56	50	400
68559904	G 1" x G 3/4	GIALLA	19	27	10	-	-	G 1"	G 3/4	-	-	58	50	400
68559908	G 1" 1/4 x G 1/2	GIALLA	24	38	11	-	-	G 1" 1/4	G 1/2	-	-	136	30	240
68559909	G 1" 1/4 x G 3/4	GIALLA	24	38	11	-	-	G 1" 1/4	G 3/4	-	-	116	30	240
68559910	G 1" 1/4 x G 1"	GIALLA	24	38	11	-	-	G 1" 1/4	G 1"	-	-	82	30	240
68559901N	G 3/4 x G 3/8	NICHELATA	14	25	8	-	-	G 3/4	G 3/8	-	-	31	100	800
68559905N	G 3/4 x G 1/2	NICHELATA	14	25	8	-	-	G 3/4	G 1/2	-	-	23	100	800
68559902N	G 1" x G 3/8	NICHELATA	19	27	10	-	-	G 1"	G 3/8	-	-	60	50	400
68559903N	G 1" x G 1/2	NICHELATA	19	27	10	-	-	G 1"	G 1/2	-	-	56	50	400
68559904N	G 1" x G 3/4	NICHELATA	19	27	10	-	-	G 1"	G 3/4	-	-	58	50	400
68559908N	G 1" 1/4 x G 1/2	NICHELATA	24	38	11	-	-	G 1" 1/4	G 1/2	-	-	136	30	240
68559909N	G 1" 1/4 x G 3/4	NICHELATA	24	38	11	-	-	G 1" 1/4	G 3/4	-	-	116	30	240
68559910N	G 1" 1/4 x G 1"	NICHELATA	24	38	11	-	-	G 1" 1/4	G 1"	-	-	82	30	240

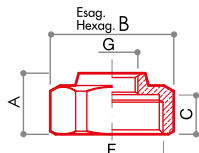

TC 435

Tappo di testa con riduzione.

CODICE	MISURA	A	B	C	D	E	F	G	H	L			
68502702	G 3/4 x G 3/8	17	31	11,5	-	-	G 3/4	G 3/8	-	-	50	100	800
68503402	G 1" x G 3/8	21	37	13	-	-	G 1"	G 3/8	-	-	66	50	400
68503406	G 1" x G 1/2	21	37	13	-	-	G 1"	G 1/2	-	-	64	50	400

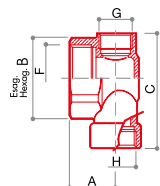

TC 440

Terminale con attacchi femmina.

CODICE	MISURA	A	B	C	D	E	F	G	H	L			
68502708	G 3/4xG 1/2xG 1/2	33	-	41	-	-	G 3/4	G 1/2	G 1/2	-	140	25	200
68503408	G 1"xG 3/8xG 1/2	23,5	37	58	-	-	G 1"	G 3/8	G 1/2	-	133	25	200

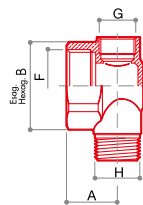

TC 445

Terminale con attacchi femmina da 3/8 (per valvola di scarico aria) e maschio da 1/2 (per valvole carico acqua).

CODICE	MISURA	A	B	C	D	E	F	G	H	L			
68502705	G 3/4	23,5	37	-	-	-	G 3/4	G 3/8	G 1/2	-	158	25	200
68503405	G 1"	23,5	37	-	-	-	G 1"	G 3/8	G 1/2	-	118	25	200

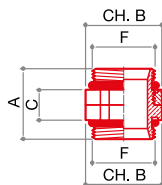

TC 465

Raccordo di unione M-M contro ghiera e con guarnizione di tenuta o-rings per collettori serie CD.

CODICE	MISURA	FINITURA	A	B	C	D	E	F	G	H	L			
68559635	G 1" x G 1"	GIALLA	37	37	16	-	-	G 1"	-	-	-	121	15	120
68559642	G 1"1/4 x G 1"1/4	GIALLA	45	48	20	-	-	G 1"1/4	-	-	-	245	10	80
68559635N	G 1" x G 1"	NICHELATA	37	37	16	-	-	G 1"	-	-	-	121	15	120
68559642N	G 1"1/4 x G 1"1/4	NICHELATA	45	48	20	-	-	G 1"1/4	-	-	-	245	10	80

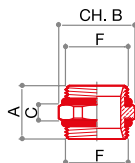

TC 464

Raccordo di unione M-M con guarnizioni o-ring.

CODICE	MISURA	FINITURA	A	B	C	D	E	F	G	H	L			
68559827	G 3/4 x G 3/4	GIALLA	27	30	7	-	-	G 3/4	-	-	-	66	80	640
68559834	G 1" x G 1"	GIALLA	28	37	8	-	-	G 1"	-	-	-	85	50	400
68559842	G 1"1/4 x G 1"1/4	GIALLA	34	48	10	-	-	G 1"1/4	-	-	-	153	20	160
68559827N	G 3/4 x G 3/4	NICHELATA	27	30	7	-	-	G 3/4	-	-	-	66	80	640
68559834N	G 1" x G 1"	NICHELATA	28	37	8	-	-	G 1"	-	-	-	85	50	400
68559842N	G 1"1/4 x G 1"1/4	NICHELATA	34	48	10	-	-	G 1"1/4	-	-	-	153	20	160

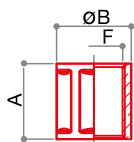
**RD 901**

Manicotto di unione diritto F - F.

CODICE	MISURA	A	B	C	D	E	F	G	H	L			
7146770N	G 3/4	33	32	-	-	-	G 3/4	-	-	-	62	30	240
7146772N	G 1"	33	41	-	-	-	G 1"	-	-	-	93	20	160

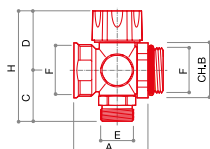
**CD 1466/1**

Collettore a 1 partenza con valvola incorporata predisposta per la regolazione elettrotermica e con cappuccio di protezione.

CODICE	MISURA	A	B	C	D	E	F	G	H	L			
15112401N	G 1" x (W24x19)	54	37	37	43	W24x19	G 1"	G 1/2	80	-	322	2	64

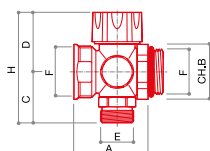
**CD 1446/1**

Collettore a 1 partenza con valvola incorporata predisposta per la regolazione elettrotermica e con cappuccio di protezione.

CODICE	MISURA	A	B	C	D	E	F	G	H	L			
15112701N	G 1" x G 3/4 EK	54	37	37	43	G 3/4 EK	G 1"	G 1/2	80	-	333	2	64

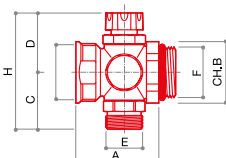
**CD 449/1**

Collettore a 1 partenza con detentore incorporato.

CODICE	MISURA	A	B	C	D	E	F	G	H	L			
15212401N	G 1" x (W24x19)	54	37	37	39	W24x19	G 1"	G 1/2	76	-	310	2	64

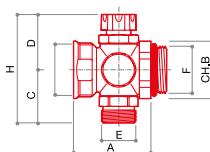
**CD 448/1**

Collettore a 1 partenza con detentore incorporato.

CODICE	MISURA	A	B	C	D	E	F	G	H	L			
15212701N	G 1" x G 3/4 EK	54	37	37	39	G 3/4 EK	G 1"	G 1/2	76	-	321	2	64

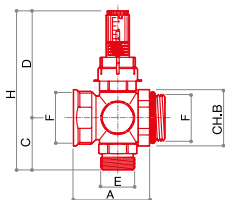
**CD 1474/1**

Collettore a 1 partenza con regolatore misuratore di portata.

CODICE	MISURA	A	B	C	D	E	F	G	H	L			
15252401N	G 1" x (W24x19)	54	37	37	76	W24x19	G 1"	G 1/2	113	-	298	2	64

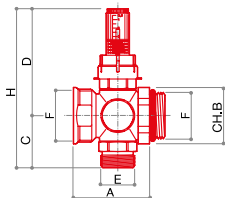
**CD 474/1**

Collettore a 1 partenza con regolatore misuratore di portata.

CODICE	MISURA	A	B	C	D	E	F	G	H	L			
15252701N	G 1" x G 3/4 EK	54	37	37	76	G 3/4 EK	G 1"	G 1/2	113	-	326	2	64

**KC 650**

Kit per collettori serie CD composto da:

- n. 1 valvola a sfera ad angolo con maniglia a farfalla di colore blu
- n. 1 valvola a sfera ad angolo con maniglia a farfalla di colore rosso
- n. 2 bocchettoni con dado girevole
- n. 2 valvole di sfiato aria manuali
- n. 2 valvole di scarico acqua
- n. 2 termometri
- n. 2 tappi laterali ciechi.

*ARTICOLO IN ESAURIMENTO.

CODICE	MISURA			
68559754	G 1"	1694	1	8
68559762*	G 1"1/4	2992	1	8

**KC 652**

Kit per collettori serie CD composto da:

- n. 1 valvola a sfera con maniglia a farfalla di colore blu
- n. 1 valvola a sfera con maniglia a farfalla di colore rosso
- n. 2 bocchettoni con dado girevole
- n. 2 valvole di sfiato aria manuali
- n. 2 valvole di scarico acqua
- n. 2 termometri
- n. 2 tappi laterali ciechi.

CODICE	MISURA			
68559758	G 1"	2112	1	8
68559766	G 1"1/4	2460	1	8

**KC 651**

Kit per collettori serie CD composto da:

- n. 1 valvola a sfera ad angolo con maniglia a farfalla di colore blu
- n. 1 valvola a sfera ad angolo con maniglia a farfalla di colore rosso
- n. 2 bocchettoni con dado girevole
- n. 2 valvole di sfiato aria automatica
- n. 2 valvole di scarico acqua
- n. 2 termometri
- n. 2 tappi laterali ciechi.

*ARTICOLO IN ESAURIMENTO.

CODICE	MISURA			
68559756	G 1"	1996	1	8
68559764*	G 1"1/4	3294	1	8

**KC 653**

Kit per collettori serie CD composto da:

- n. 1 valvola a sfera con maniglia a farfalla di colore blu
- n. 1 valvola a sfera con maniglia a farfalla di colore rosso
- n. 2 bocchettoni con dado girevole
- n. 2 valvole di sfiato aria automatica
- n. 2 valvole di scarico acqua
- n. 2 termometri
- n. 2 tappi laterali ciechi.

CODICE	MISURA			
68559760	G 1"	2414	1	8
68559768	G 1"1/4	2762	1	8

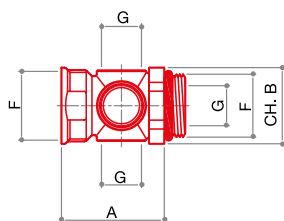
**CR 489**

Bocchettone a tenuta morbida con contro ghiera per valvola a sfera a 3 attacchi.

CODICE	MISURA	A	B	C	D	E	F	G	H	L			
68503425	G 1" x G 1/2	54	37	-	-	-	G 1"	G 1/2	-	-	187	16	128

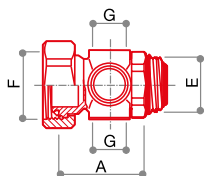
**CR 491**

Bocchettone a tenuta morbida per valvola a sfera a 3 attacchi con dado girevole.

CODICE	MISURA	A	B	C	D	E	F	G	H	L			
68559781	G 1" x G 1/2	53	-	-	-	G 1"	G 1"1/4	G 1/2	-	-	230	16	128
68559785	G 1"1/4 x G 1/2	66	-	-	-	G 1"1/4	G 1"1/2	G 1/2	-	-	382	8	64

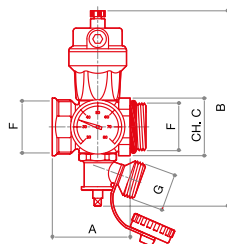
**CR 490**

Bocchettone a tenuta morbida con contro ghiera per valvola a sfera con termometro orientabile, valvola di sfiato automatica e rubinetto di svuotamento orientabile.

CODICE	MISURA	A	B	C	D	E	F	G	H	L			
68503430	G 1"	54	136	37	-	-	G 1"	G 3/4	-	-	530	4	32

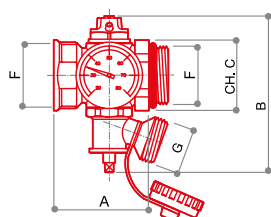
**CR 492**

Bocchettone a tenuta morbida con contro ghiera per valvola a sfera con termometro orientabile, valvola di sfiato manuale e rubinetto di svuotamento orientabile.

CODICE	MISURA	A	B	C	D	E	F	G	H	L			
68503434	G 1"	54	90	37	-	-	G 1"	G 3/4	-	-	379	4	32

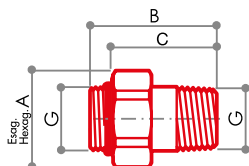
**RD 458**

Raccordo di unione M-M in tre pezzi con guarnizione o-ring.

CODICE	MISURA	A	B	C	D	E	F	G	H	L			
68992700N	G 3/4	37	52	42	-	-	-	G 3/4	-	-	168	20	160
68993400N	G 1"	47	54	45	-	-	-	G 1"	-	-	262	15	120

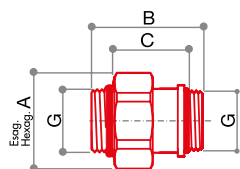
**RD 455**

Raccordo di unione M-M in tre pezzi con guarnizione o-ring.

CODICE	MISURA	A	B	C	D	E	F	G	H	L			
68992701N	G 3/4	37	48	29	-	-	-	G 3/4	-	-	120	20	160
68993401N	G 1"	46	48	28	-	-	-	G 1"	-	-	238	15	120

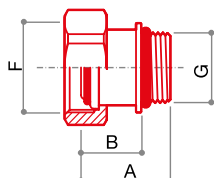
**CR 498**

Dado e raccordo nichelati, con tenuta o-ring per il collegamento delle valvole ai collettori di distribuzione.

CODICE	MISURA	A	B	C	D	E	F	G	H	L			
67901700	DN 10 3/8	26	18	-	-	-	G 5/8	G 3/8	-	-	60	50	400
67902100	DN 15 1/2	26	18	-	-	-	G 3/4	G 1/2	-	-	71	50	400
67902700	DN 20 3/4	33	23	-	-	-	G 1"	G 3/4	-	-	120	20	160
67903400	DN 25 1"	36	25	-	-	-	G 1 1/4	G 1"	-	-	220	15	120
67904200	DN 32 1 1/4	41	35	-	-	-	G 1 1/2	G 1 1/4	-	-	240	10	80

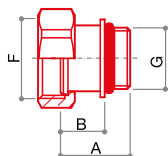
**CR 498/A**

Dado e raccordo nichelati, con tenuta piana.

CODICE	MISURA	A	B	C	D	E	F	G	H	L			
67922100	DN 15 1/2	23	15	-	-	-	G 3/4	G 1/2	-	-	68	50	400
67922700	DN 20 3/4	29,5	19,5	-	-	-	G 1"	G 3/4	-	-	104	20	160
67924200	DN 32 1 1/4	36	22,5	-	-	-	G 1 1/2	G 1 1/4	-	-	217	10	80

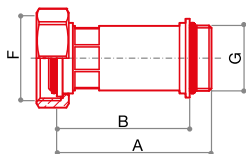
**CR 498/B**

Raccordo CR 498 maggiorato di 50 mm.

CODICE	MISURA	A	B	C	D	E	F	G	H	L			
67913400	DN 25 1"	77	66	-	-	-	G 1 1/4	G 1"	-	-	245	10	80

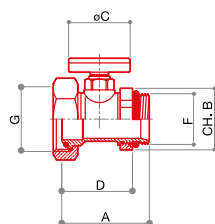
**CR 499**

Raccordo nichelato con dado girevole, contro ghiera e tenuta o-ring completo di termometro per il collegamento valvole a sfera ai collettori di distribuzione serie CD.

CODICE	MISURA	A	B	C	D	E	F	G	H	L			
68503428	G 1"	57	37	40	46	-	G 1"	G 1 1/4	-	-	270	8	64
68504228	G 1 1/4	78	48	40	66	-	G 1 1/4	G 1 1/2	-	-	496	4	32

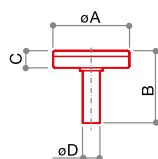

RT 488
Termometro.

CODICE	MISURA	A	B	C	D	E	F	G	H	L			
68559854	-	40	42	10	9	-	-	-	-	-	28	15	120

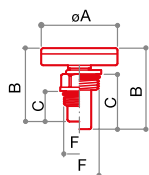

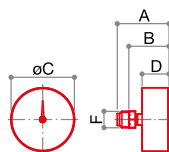

RT 487
Termometro con pozzetto.

CODICE	MISURA	A	B	C	D	E	F	G	H	L			
68559851	G 3/8	40	40	16	-	-	G 3/8	-	-	-	56	10	80
68559852	G 1/2	40	43	29	-	-	G 1/2	-	-	-	56	10	80



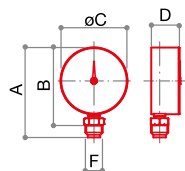

RTA 489
Termometro assiale con raccordo
provvisto di valvola di ritegno.

CODICE	MISURA	A	B	C	D	E	F	G	H	L			
68559855	G 1/2	65	51	80	34	-	G 1/2	-	-	-	155	1	50



RTR 490
Termometro radiale con raccordo
provvisto di valvola di ritegno.

CODICE	MISURA	A	B	C	D	E	F	G	H	L			
68559856	G 1/2	108	94	80	34	-	G 1/2	-	-	-	152	1	50

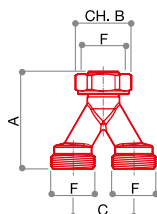

SD 484

Raccordo sdoppiatore nichelato.

CODICE	MISURA	A	B	C	D	E	F	G	H	L			
68502419	(W24x19)	58	27	36	-	-	W24x19	-	-	-	130	10	80
68502700	G 3/4 EK	58	30	36	-	-	G 3/4 EK	-	-	-	147	10	80

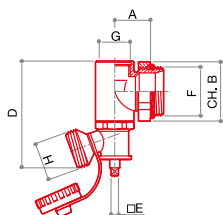

SA 483

Terminale per collettori, nichelato, con contro ghiera e rubinetto di scarico acqua incorporato in ottone:

- attacco per valvola di scarico aria.

CODICE	MISURA	A	B	C	D	E	F	G	H	L			
68503409	G 1" x G 3/8	24	37	-	72	5	G 1"	G 3/8	G 3/4	-	252	10	80
68503424	G 1" x G 1/2	24	37	-	72	5	G 1"	G 1/2	G 3/4	-	242	10	80

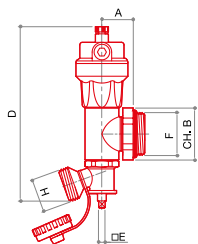

SA 483/A

Terminale per collettori, nichelato, con contro ghiera, rubinetto di scarico acqua in ottone e valvola di sfianto incorporata.

CODICE	MISURA	A	B	C	D	E	F	G	H	L			
68503423	G 1"	24	37	-	135	5	G 1"	-	G 3/4	-	417	8	64

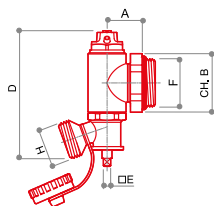

SA 483/B

Terminale per collettori, nichelato, con contro ghiera, rubinetto di scarico acqua in ottone e valvola di sfianto manuale incorporata.

CODICE	MISURA	A	B	C	D	E	F	G	H	L			
68503426	G 1"	24	37	-	90	5	G 1"	-	G 3/4	-	266	8	64

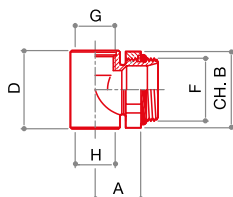

TC 488

Terminale per collettori con contro ghiera:

- attacco da G 3/8 F o G 1/2 F per valvola di scarico aria;
- attacco da G 1/2 F per valvola di scarico acqua.

CODICE	MISURA	A	B	C	D	E	F	G	H	L			
68503420	G 1/2 x G 1/2	24	37	-	41	-	G 1"	G 1/2	G 1/2	-	130	20	160
68503422	G 1/2 x G 3/8	24	37	-	41	-	G 1"	G 3/8	G 1/2	-	140	20	160

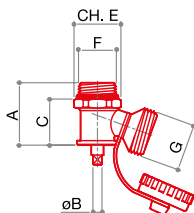
**SA 492**

Valvola di scarico acqua nichelata con tappo, laccetto e possibilità di rotazione dello scarico.

CODICE	MISURA	A	B	C	D	E	F	G	H	L			
68559815	G 1/2	34	5	25,5	-	24	G 1/2	G 3/4	-	-	112	30	240

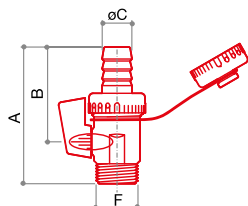
**SA 494**

Valvola a sfera nichelata per scarico acqua con leva, portagomma e tappo.

CODICE	MISURA	A	B	C	D	E	F	G	H	L			
68559799	G 1/2	68	47	15	-	-	G 1/2	-	-	-	107	15	120

**CB 1205**

Coibentatura per collettori serie CD e CX per 12 attacchi.

CODICE	MISURA			
72000064	CD G 1"	156	-	6
72000066	CX G 1"	149	-	6
72000065	CD G 1 1/4	180	-	6

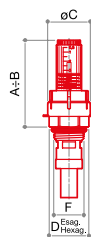
**TM 4012**

Regolatore e misuratore di portata 0,5÷5 l/min.

CODICE	MISURA	A	B	C	D	E	F	G	H	L			
69000010	G 1/2	57	61	30	24	-	G 1/2	-	-	-	60	25	200

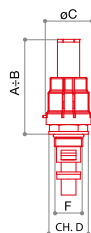
**TM 4014**

Regolatore e misuratore di portata 0,5÷5 l/min.

CODICE	MISURA	A	B	C	D	E	F	G	H	L			
69000018	G 1/2	68,5	74	32,5	24	-	G 1/2	-	-	-	36	20	160

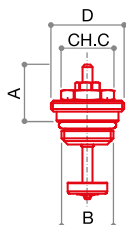

560

Vitone termostatico di comando per collettori serie CD.

CODICE	MISURA	QUOTA DI CHIUSURA	CORSA	A	B	C	D	E	F	G	H	L			
9446870	G 1/2	11,8	2,7	2,7	23	G 1/2	19	-	-	-	-		66	50	400



516

Completo assemblato di tenuta per astina di comando del vitone termostatico e termoelettrico.

CODICE	MISURA			
67980200	-	6	-	-

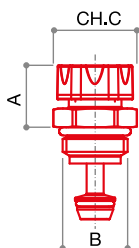

563

Vitone detentore predisposto per la doppia regolazione micrometrica di bilanciamento per collettori serie CD.

CODICE	FINITURA	MISURA	CORSA	A	B	C	D	E	F	G	H	L			
9446841	GIALLA	G 1/2	7,8	20	G 1/2	24	-	-	-	-	-	-	66	50	400
9446843	NICHELATA	G 1/2	7,8	20	G 1/2	24	-	-	-	-	-	-	66	50	400

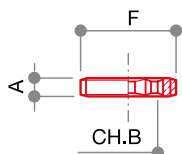

501

Ghiera di regolazione per detentori per collettori serie CD.

CODICE	MISURA	A	B	C	D	E	F	G	H	L			
3346656	-	5	8	-	-	-	G 1/4	-	-	-	1	-	-

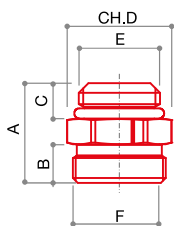

567

Raccordo con sede per vitone termostatico di comando articolo 560, vitone detentore di regolazione articolo 563 e per regolatore e misuratore di portata articolo TM 4012, per collettori serie CD.

CODICE	MISURA	FINITURA	A	B	C	D	E	F						
68552678	CD G 1" G 1/2 x (W24x19)	GIALLA	26	10	9,3	24	G 1/2	W24x19	TR 91	TP 95	TP 97	43	50	400
68552679	CD G 1 1/4 G 1/2 x (W24x19)	GIALLA	36	10	19,3	24	G 1/2	W24x19	TR 91	TP 95	TP 97	49	50	400
68552675	CD G 1" G 1/2 x G3/4 EK	GIALLA	26	10,5	9,3	27	G 1/2	G 3/4 EK	TR 91/A	TP 98	TP 99	54	50	400
68552677	CD G 1 1/4 G 1/2 x G3/4 EK	GIALLA	36	10,5	19,3	27	G 1/2	G 3/4 EK	TR 91/A	TP 98	TP 99	60	50	400
68552678N	CD G 1" G 1/2 x (W24x19)	NICHELATA	26	10	9,3	24	G 1/2	W24x19	TR 91	TP 95	TP 97	43	50	400
68552679N	CD G 1 1/4 G 1/2 x (W24x19)	NICHELATA	36	10	19,3	24	G 1/2	W24x19	TR 91	TP 95	TP 97	49	50	400
68552675N	CD G 1" G 1/2 x G3/4 EK	NICHELATA	26	10,5	9,3	27	G 1/2	G 3/4 EK	TR 91/A	TP 98	TP 99	53	50	400
68552677N	CD G 1 1/4 G 1/2 x G3/4 EK	NICHELATA	36	10,5	19,3	27	G 1/2	G 3/4 EK	TR 91/A	TP 98	TP 99	60	50	400

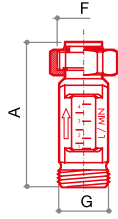
**TM 4005**

Misuratore di portata 1÷4 l/min.







CODICE	MISURA	A	B	C	D	E	F	G	H	L						
69000012	(W24x19) x (W24x19)	72	-	-	-	-	W24x19	W24x19	-	-	TR 91	TP 95	TP 97	126	25	200
69000015	G 3/4 EK x G 3/4 EK	64	-	-	-	-	G 3/4 EK	G 3/4 EK	-	-	TR 91/A	TP 98	TP 99	138	25	200

DIAGRAMMA DI PORTATA MISURATORE DI PORTATA



ARTICOLI	MISURA	Kvs	POS
TM 4005	W24x19	1,15	1
TM 4005	G 3/4 EK		2

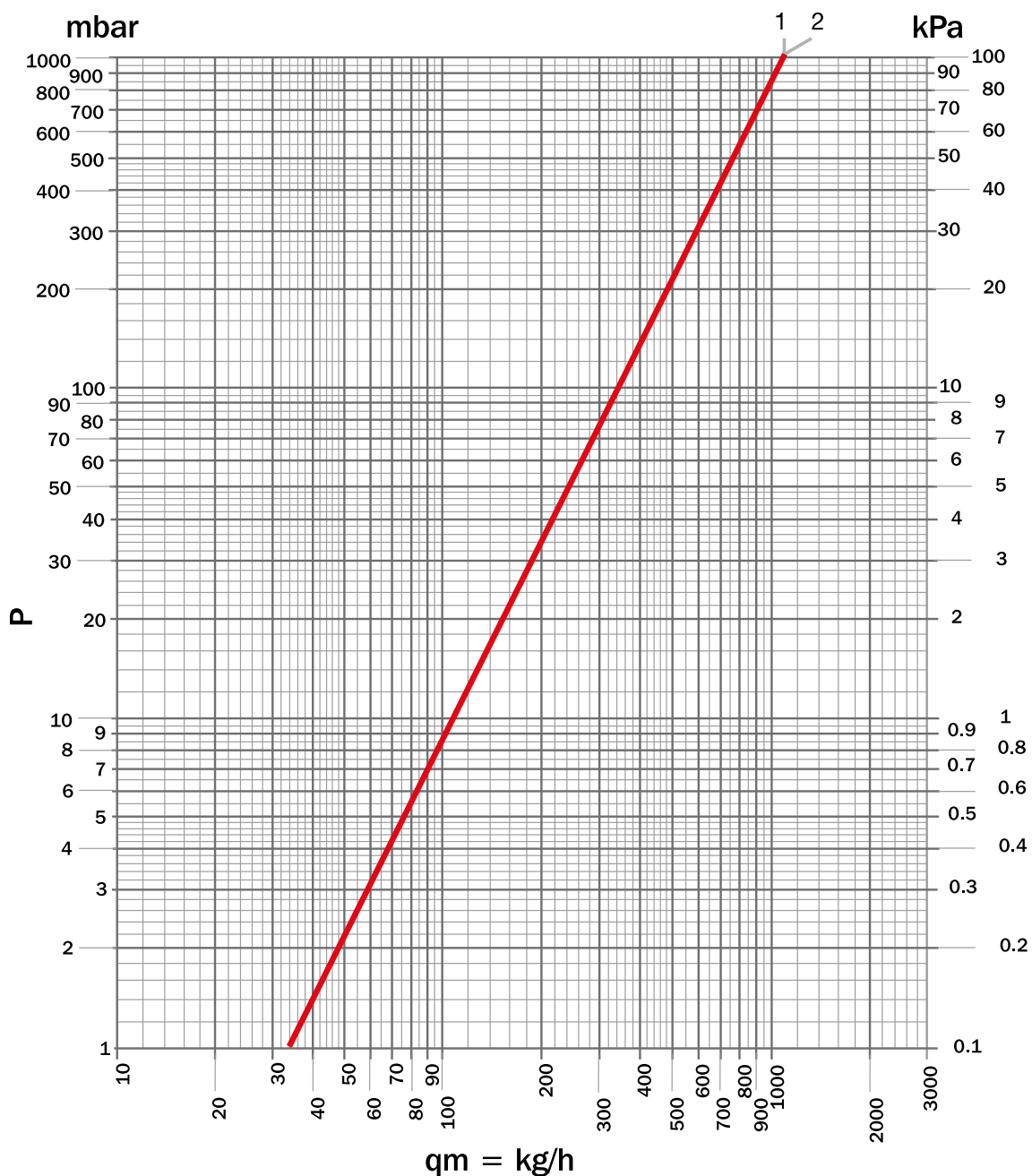
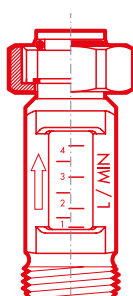

STAFFA REGOLABILE SC 497



La staffa ha un interasse regolabile da 200 - 210 - 220 - 230 - 240 - 250 - 260 mm in base alla necessità.

La staffa universale è adatta per tutti i collettori Luxor ad esclusione della serie CD da G1"1/4.

CARATTERISTICHE TECNICHE



Materiale vite

Fe



Materiale staffa

DD11



Materiale cavallotto

PA6

ISTRUZIONI UTILIZZO STAFFE REGOLABILI SC 497



1. Inserire i cavallotti sulla staffa facendoli scorrere nel profilo ad "H".



2. Allineare il foro centrale con l'interasse voluto (esempio nell'immagine 200mm), regolazione da 200mm a 260mm.

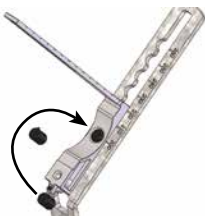

3. Staccare il perno di blocco dal cavallotto e inserirlo ad incastro nell'apposita sede.

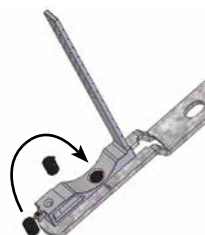

4. Ripetere l'operazione con l'altro cavallotto per la posizione fissa non regolabile.



5. Il cavallotto è composto da una fascetta flessibile che può avvolgere qualsiasi forma del prodotto da fissare con questa staffa.



6. La fascetta può essere bloccata in 2 modi. Il primo prevede di inserire il perno fisso del cavallotto in uno dei fori della fascetta. In questo modo si ottiene un posizionamento del prodotto senza l'utilizzo di utensili. In alcune installazioni potrebbe essere sufficiente perché non è necessario ancorare saldamente il collettore.



7. La fascetta può essere bloccata in 2 modi. Il secondo prevede l'utilizzo di una vite autofilettante che posizionata nell'opportuno foro della fascetta può serrare e bloccare saldamente il collettore alla staffa.

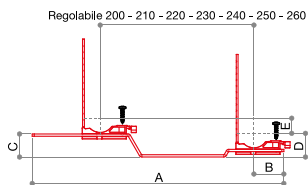

SC 497

Staffa in metallo/poliammide regolabile universale per il fissaggio dei collettori alle cassette in metallo oppure a parete.

CODICE	MISURA	A	B	C	D	E	F	G	H	L			
68559538	-	327.5	39	30	30.5	20	-	-	-	-	140	-	100

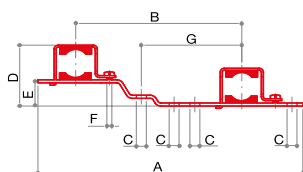

SC 496

Supporto metallico per collettori serie CD e CX.

CODICE	MISURA	A	B	C	D	E	F	G	H	L			
68559528	CD G 3/4 x 200	319	200	12	79	34	6 MA	119	-	-	270	-	100
68559535	CD G 1" x 200	319	200	12	79	30	6 MA	119	-	-	260	-	100
68559537	CX G 1" x 200	319	200	12	79	30	6 MA	119	-	-	265	-	100
68559734	CD G 1" x 250	366	250	12	89	-	6 MA	-	-	-	294	-	50
68559543	CD G 1"1/4 x 200	319	200	12	90	30	6 MA	114	-	-	290	-	80

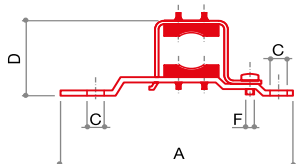

SC 496/A

Supporto metallico semplice per collettori.

CODICE				A	B	C	D	E	F			
68559429	3/4	1"	3/4	162,5	-	12	56,5	-	6 MA	140	-	100
68559436	1"	-	-	162,5	-	12	56,5	-	6 MA	134	-	100
68559437	-	-	1"	162,5	-	12	56,5	-	6 MA	138	-	100
68559442	1"1/4	-	-	162,5	-	12	56,5	-	6 MA	148	-	100

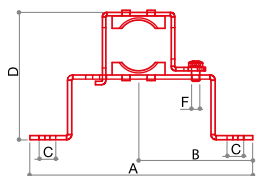

SC 496/B

Supporto metallico alto semplice per collettori.

CODICE				A	B	C	D	E	F			
68559428	3/4	1"	3/4	160	82	12	92	-	6 MA	136	-	70
68559435	1"	-	-	160	82	12	92	-	6 MA	136	-	70
68559433	-	-	1"	160	82	12	92	-	6 MA	140	-	70
68559443	1"1/4	-	-	160	87	12	103	-	6 MA	149	-	70

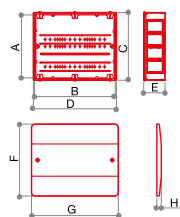
**CF 477**

Cassetta componibile universale in plastica con fondo completa di rete da intonaco supporti per bloccaggio collettori semplici componibili, collettori complanari e collettori di distribuzione.

CODICE	MISURA	A	B	C	D	E	F	G	H	L			
68560432	272 x 332 x 86	260	320	272	332	86	290	350	18	-	1000	1	20
68560440	272 x 412 x 86	260	400	272	412	86	290	430	18	-	1250	1	20
68560450	272 x 512 x 86	260	500	272	512	86	290	530	18	-	1500	1	20
68560460	272 x 612 x 86	260	600	272	612	86	290	630	18	-	1750	1	20

**AC 477**

Kit accessori di **ricambio** per il fissaggio dei collettori nella cassetta CF 477.

CODICE	MISURA			
68560001	-	60	1	-

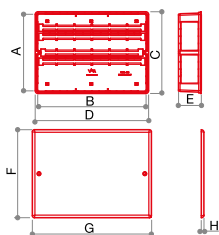
**CF 479**

Cassetta universale in plastica con fondo completa di supporti per bloccaggio collettori semplici componibili, collettori complanari e collettori di distribuzione.

CODICE	MISURA	A	B	C	D	E	F	G	H	L			
68560332	290 x 330 x 88	280	320	290	330	88	320	360	10	-	930	1	5
68560342	310 x 430 x 88	300	420	310	430	88	340	460	10	-	1175	1	5
68560352	330 x 530 x 88	320	520	330	530	88	360	560	10	-	1425	1	5
68560362	330 x 625 x 88	320	615	330	625	88	360	660	10	-	1715	1	5



**AC 479**

Kit accessori di **ricambio** per il fissaggio dei collettori nella cassetta CF 479.

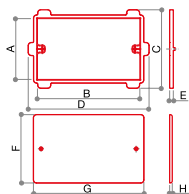
CODICE	MISURA			
68560005	-	70	1	-

**CT 474**

Coperchio con telaio in plastica.

CODICE	MISURA	A	B	C	D	E	F	G	H	L			
68560040	240 x 400	230	390	305	465	14	265	425	10	-	501	-	50
68560050	240 x 500	230	490	305	565	14	265	525	10	-	622	-	35
68560060	240 x 600	230	590	305	665	14	265	625	10	-	752	-	35



CT 488

Cornice e porta in acciaio verniciato di bianco RAL 9016. Ricambio per CF 485, CF 486, CF 487 e CF 492.

ARTICOLO IN ESAURIMENTO.

CODICE	MISURA			
68561005	500 x 450	3	-	1
68561007	700 x 450	4	-	1
68561008	850 x 450	5	-	1
68561010	1000 x 450	6	-	1
68561012	1200 x 450	7	-	1



CT 489

Cornice e porta in acciaio verniciato di bianco RAL 9016. Ricambio per CF 489, CF 490 e CF 491.

ARTICOLO IN ESAURIMENTO.

CODICE	MISURA			
68561105	500 x 560	4	-	1
68561107	700 x 560	5	-	1
68561108	850 x 560	6	-	1
68561110	1000 x 560	7	-	1
68561112	1200 x 560	8	-	1
68561113	1300 x 560	9	-	1

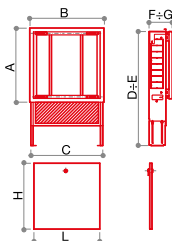

CF 485

Cassetta a muro per riscaldamento e sanitario in acciaio zincato, con telaio e supporto regolabili, porta e cornice verniciate di colore bianco RAL 9016 per collettori serie CD.

CODICE	MISURA	A	B	C	D	E	F	G	H	L			
68560705	500 x 620 x 110	530	562	500	620	750	110	150	450	490	8	-	1
68560707	700 x 620 x 110	530	762	700	620	750	110	150	450	690	11	-	1
68560708	850 x 620 x 110	530	912	850	620	750	110	150	450	840	14	-	1
68560710	1000 x 620 x 110	530	1062	1000	620	750	110	150	450	990	17	-	1
68560712	1200 x 620 x 110	530	1262	1200	620	750	110	150	450	1190	20	-	1

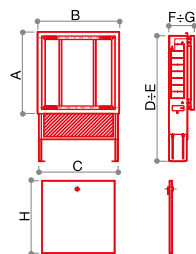

CF 490

Cassetta a muro per riscaldamento e sanitario in acciaio zincato, con telaio e supporto regolabili, porta e cornice verniciate di colore bianco RAL 9016 per collettori serie CD.

CODICE	MISURA	A	B	C	D	E	F	G	H	L			
68561405	500 x 720 x 90	630	560	500	720	860	90	130	560	490	9	-	1
68561407	700 x 720 x 90	630	760	700	720	860	90	130	560	690	12	-	1
68561408	850 x 720 x 90	630	910	850	720	860	90	130	560	840	15	-	1
68561410	1000 x 720 x 90	630	1060	1000	720	860	90	130	560	990	18	-	1
68561412	1200 x 720 x 90	630	1260	1200	720	860	90	130	560	1190	21	-	1
68561413	1300 x 720 x 90	630	1360	1300	720	860	90	130	560	1290	22,5	-	1

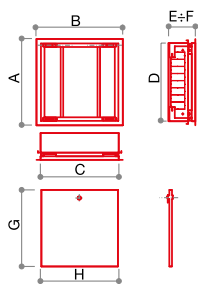
**CF 491**

Cassetta a muro per riscaldamento e sanitario in acciaio zincato, con telaio regolabile, porta e cornice verniciate di colore bianco RAL 9016 per collettori serie CD.

CODICE	MISURA	A	B	C	D	E	F	G	H	L			
68561505	500 x 600 x 90	630	560	500	600	90	130	560	490	-	8	-	1
68561507	700 x 600 x 90	630	760	700	600	90	130	560	690	-	11	-	1
68561508	850 x 600 x 90	630	910	850	600	90	130	560	840	-	13	-	1
68561510	1000 x 600 x 90	630	1060	1000	600	90	130	560	990	-	15	-	1
68561512	1200 x 600 x 90	630	1260	1200	600	90	130	560	1190	-	18	-	1

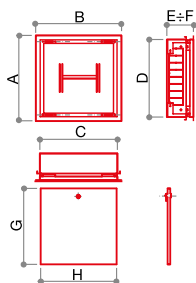
**CF 492**

Cassetta a muro per riscaldamento e sanitario in acciaio zincato, con telaio regolabile, porta e cornice verniciate di colore bianco RAL 9016 per collettori serie CD.

CODICE	MISURA	A	B	C	D	E	F	G	H	L			
68561605	500 x 500 x 80	530	562	500	500	80	120	450	490	-	7	-	1
68561607	700 x 500 x 80	530	762	700	500	80	120	450	690	-	9	-	1
68561608	850 x 500 x 80	530	912	850	500	80	120	450	840	-	10,5	-	1

**AC 490**

Kit accessori: guide e bulloni di ricambio per cassette CF 485 e CF 492.

CODICE	MISURA			
68560002	-	434	1	-

**AC 489**

Kit accessori: guide e bulloni di ricambio per cassette CF 490 e CF 491.

CODICE	MISURA			
68560003	-	506	1	-

G 1"

SCHEMA PER SELEZIONARE LA CASSETTA CORRETTA

COLLETTORI DA G 1"

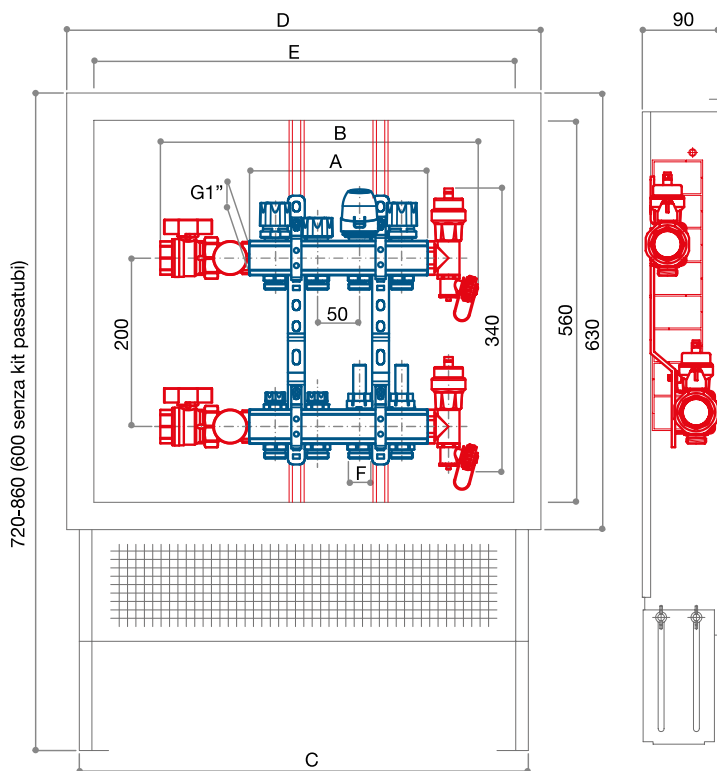

							CASSETTE	
VIE	A	B	C	D	E	F	ART.	COD.
2	112	276	500	560	490	W24x19 - G 3/4 EK	CF 490	68561405
3	162	326						
4	212	376						
5	262	426	700	760	690		CF 490	68561407
6	312	476						
7	362	526						
8	412	576	850	910	840		CF 490	68561408
9	462	626						
10	512	676						
11	562	726	1000	1060	990		CF 490	68561410
12	612	776						
13	662	826						

COLLETTORI DA G 1" CON SPURGO

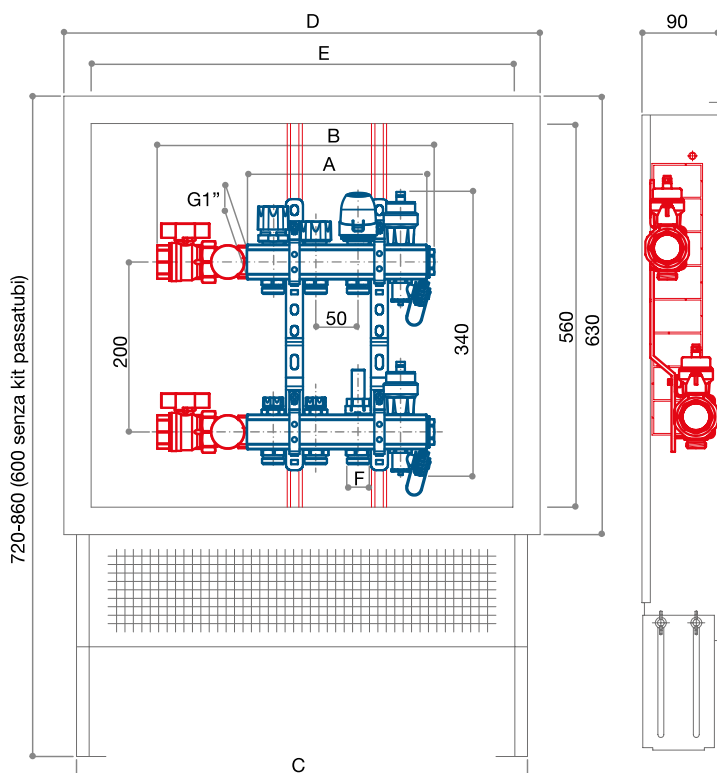

							CASSETTE	
VIE	A	B	C	D	E	F	ART.	COD.
2	162	276	500	560	490	W24x19 - G 3/4 EK	CF 490	68561405
3	212	326						
4	262	376						
5	312	426	700	760	690		CF 490	68561407
6	362	476						
7	412	526						
8	462	576	850	910	840		CF 490	68561408
9	512	626						
10	562	676						
11	612	726	662	776				
12	662	776						

G 1 1/4

SCHEMA PER SELEZIONARE LA CASSETTA CORRETTA

COLLETTORI DA G 1 1/4

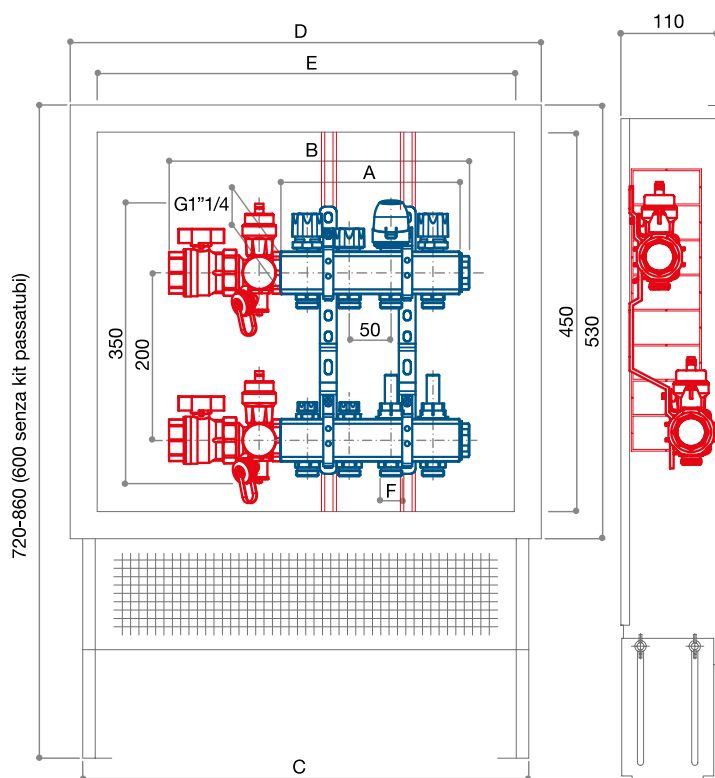

							CASSETTE	
VIE	A	B	C	D	E	F	ART.	COD.
2	114	260	500	565	490	W24x19 - G 3/4 EK	CF 485	68560705
3	164	310						
4	214	360						
5	264	410						
6	314	460	700	765	690		CF 485	68560707
7	364	510						
8	414	560						
9	464	610	850	915	840		CF 485	68560708
10	514	660						
11	564	710						
12	614	760	1000	1065	990		CF 485	68560710
13	664	810						

COLLETTORI DA G 1 1/4 CON SPURGO

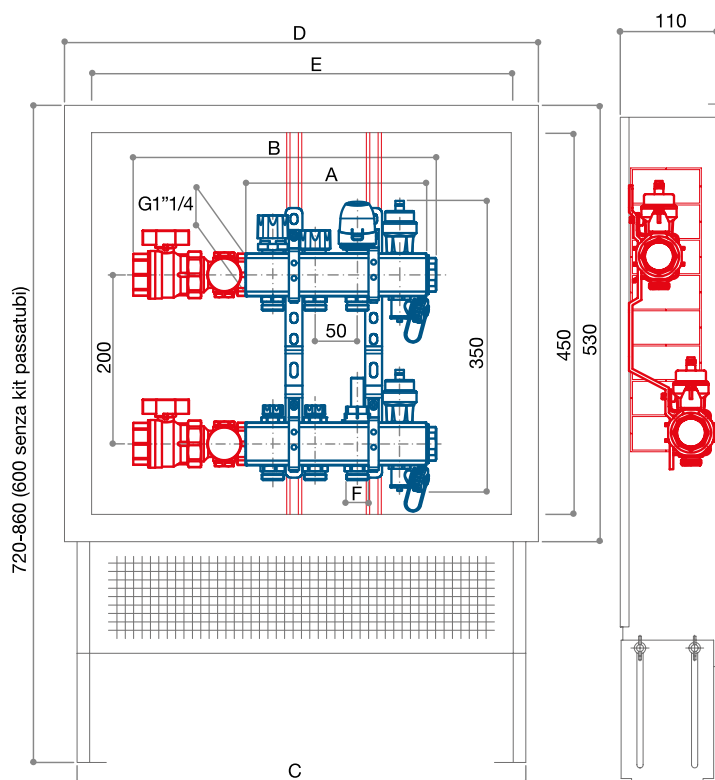

							CASSETTE	
VIE	A	B	C	D	E	F	ART.	COD.
2	164	310	500	565	490	W24x19 - G 3/4 EK	CF 485	68560705
3	214	360						
4	264	410						
5	314	460						
6	364	510	700	765	690		CF 485	68560707
7	414	560						
8	464	610						
9	514	660	850	915	840		CF 485	68560708
10	564	710						
11	614	760						
12	664	810	1000	1065	990		CF 485	68560710

G 1"

SCHEMA PER SELEZIONARE LA CASSETTA CORRETTA

COLLETTORI DA G 1"

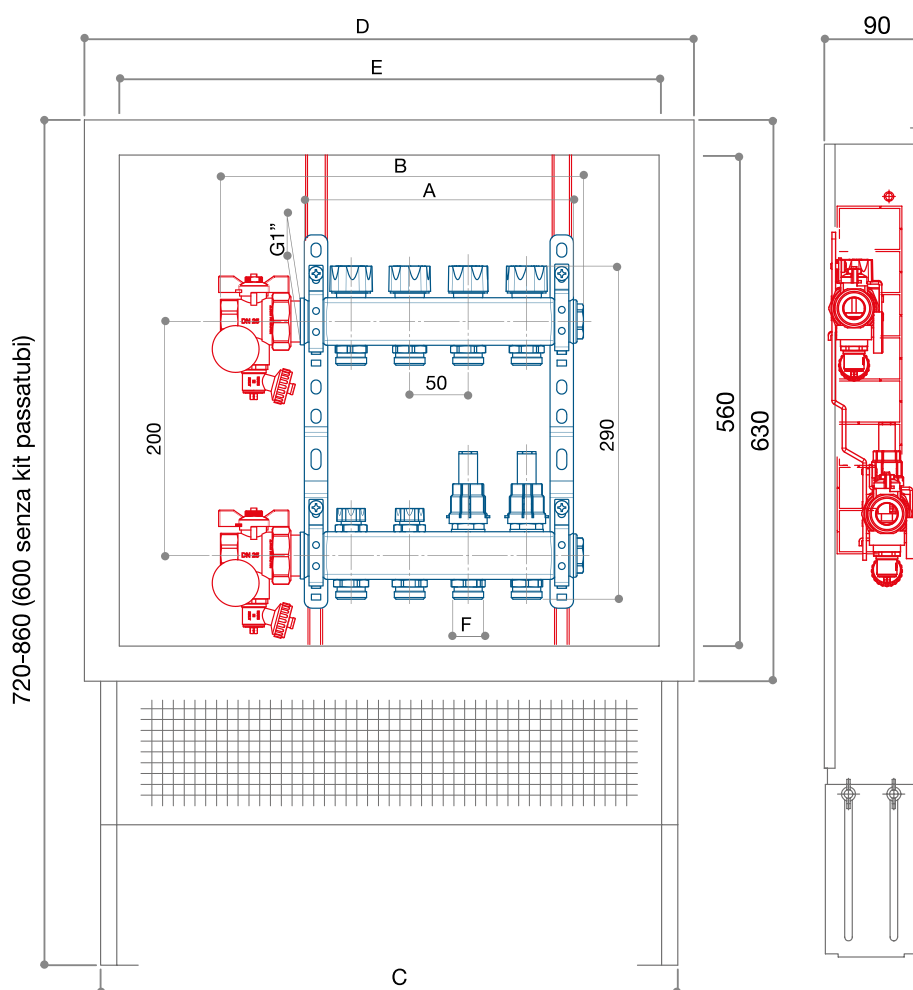

VIE	A	B	CASSETTE					
			C	D	E	F	ART.	COD.
2	130	210	500	560	490	W24x19 - G 3/4 EK	CF 490	68561405
3	180	260						
4	230	310						
5	280	360						
6	330	410	700	760	690	W24x19 - G 3/4 EK	CF 490	68561407
7	380	460						
8	430	510						
9	480	560						
10	530	610	850	910	840	W24x19 - G 3/4 EK	CF 490	68561408
11	580	660						
12	630	710						
13	680	760						
14	730	810	1000	1060	990	W24x19 - G 3/4 EK	CF 490	68561410
15	780	860						
16	830	910						



3 / VALVOLE

VALVOLE A SFERA



CARATTERISTICHE TECNICHE



Max temperatura

90 °C



Max pressione

10 bar



Materiale

CW617N

CARATTERISTICHE COSTRUTTIVE

Tutte le valvole a sfera Luxor vengono prodotte in ottone CW617N e sono compatibili con i collettori e con gli altri componenti prodotti da Luxor.

Data la varietà delle misure e delle tipologie, riescono a soddisfare le più svariate esigenze di utilizzo.

Tutte le valvole a sfera hanno il perno di manovra montato dall'interno. Questo sistema è chiamato "antiscoppio" perché offre maggiori garanzie contro la fuoriuscita accidentale del perno e del relativo sistema di tenuta, e per l'impossibilità di essere manomesso dall'esterno.

Le valvole a sfera presentano una doppia tenuta con anelli O-Ring in elastomero, scelto per l'elevata resistenza all'invecchiamento.

In conformità al D.M. 174/2004 per il trasporto di acque potabili, la lavorazione delle valvole viene eseguita dopo la fase di nichelatura, garantendo l'igienicità del particolare e un'aprezzabile qualità estetica.

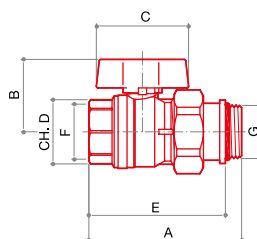

VC 471

Valvola a sfera a passaggio totale, nichelata, con maniglia a farfalla di colore blu o rosso e raccordo articolo CR 498 con o-ring per attacco al collettore.

CODICE	MISURA	A	B	C	D	E	F	G	H	L			
68559772B	G 1/2	69	40	48	25	61	G 1/2	G 1/2	-	-	210	10	80
68559772R	G 1/2	69	40	48	25	61	G 1/2	G 1/2	-	-	210	10	80
68559805B	G 3/4	90	39	60	33	80	G 3/4	G 3/4	-	-	370	10	80
68559805R	G 3/4	90	39	60	33	80	G 3/4	G 3/4	-	-	370	10	80
68559807B	G 1"	89	43	60	41	78	G 1"	G 1"	-	-	467	5	40
68559807R	G 1"	89	43	60	41	78	G 1"	G 1"	-	-	467	5	40
68559825B	G1"1/4	123	53	72	50	109	G 1"1/4	G 1"1/4	-	-	907	3	24
68559825R	G1"1/4	123	53	72	50	109	G 1"1/4	G 1"1/4	-	-	907	3	24

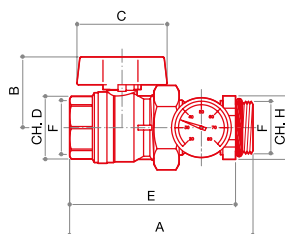

VC 471/A

Valvola a sfera con maniglia a farfalla di colore blu o rosso completa di termometro scala 0 °C÷80 °C per collettori serie CD.

CODICE	MISURA	A	B	C	D	E	F	G	H	L			
68559800B	G 1"	115	43	60	41	104	G 1"	-	37	-	562	4	32
68559800R	G 1"	115	43	60	41	104	G 1"	-	37	-	562	4	32

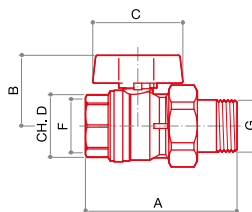
**VC 472**

Valvola a sfera a passaggio totale, nichelata, con maniglia a farfalla di colore blu o rosso e raccordo.

CODICE	MISURA	A	B	C	D	E	F	G	H	L			
68559774B	G 1/2	73	40	48	25	-	G 1/2	G 1/2	-	-	205	10	80
68559774R	G 1/2	73	40	48	25	-	G 1/2	G 1/2	-	-	205	10	80
68559806B	G 3/4	91	39	60	33	-	G 3/4	G 3/4	-	-	365	10	80
68559806R	G 3/4	91	39	60	33	-	G 3/4	G 3/4	-	-	365	10	80
68559808B	G 1"	95	43	60	41	-	G 1"	G 1"	-	-	487	5	40
68559808R	G 1"	95	43	60	41	-	G 1"	G 1"	-	-	487	5	40
68559818B	G 1"1/4	126	53	72	50	-	G 1"1/4	G 1"1/4	-	-	904	3	24
68559818R	G 1"1/4	126	53	72	50	-	G 1"1/4	G 1"1/4	-	-	904	3	24

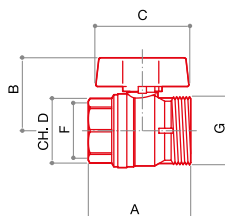
**VC 475**

Valvola a sfera a passaggio totale, nichelata, senza bocchettone, con maniglia a farfalla di colore blu o rosso.

CODICE	MISURA	A	B	C	D	E	F	G	H	L			
68559770B	G 1/2F x G 3/4M	45	40	48	25	-	G 1/2	G 1/2	-	-	138	10	80
68559770R	G 1/2F x G 3/4M	45	40	48	25	-	G 1/2	G 1/2	-	-	138	10	80
68559811B	G 3/4F x G 1"M	59	39	60	33	-	G 3/4	G 1"	-	-	252	10	80
68559811R	G 3/4F x G 1"M	59	39	60	33	-	G 3/4	G 1"	-	-	252	10	80
68559809B	G 1"F x G 1"1/4M	61	43	60	41	-	G 1"	G 1"1/4	-	-	311	5	40
68559809R	G 1"F x G 1"1/4M	61	43	60	41	-	G 1"	G 1"1/4	-	-	311	5	40
68559804B	G 1"1/4F x G 1"1/2M	87	53	72	50	-	G 1"1/4	G 1"1/2	-	-	666	3	24
68559804R	G 1"1/4F x G 1"1/2M	87	53	72	50	-	G 1"1/4	G 1"1/2	-	-	666	3	24

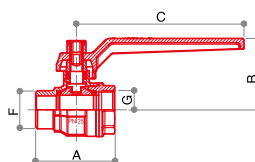
**VC 476**

Valvola a sfera a passaggio totale, nichelata, senza bocchettone, con leva di colore blu o rossa.

CODICE	MISURA	A	B	C	D	E	F	G	H	L			
68559829B	G 1"1/2	91	75	150	-	-	G 1"1/2	G 1"1/2	-	-	1400	2	16
68559829R	G 1"1/2	91	75	150	-	-	G 1"1/2	G 1"1/2	-	-	1400	2	16

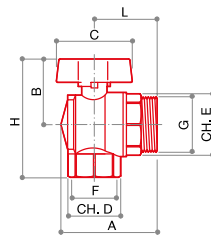

VS 470

Valvola a sfera a passaggio totale, nichelata, senza bocchettone, con maniglia a farfalla di colore blu o rosso.
*ARTICOLO IN ESAURIMENTO.

CODICE	MISURA	A	B	C	D	E	F	G	H	L			
68559810B	G 1" F x G 1" 1/4 M	72	50	57	39	43	G 1"	G 1" 1/4	90	47	582	5	40
68559810R	G 1" F x G 1" 1/4 M	72	50	57	39	43	G 1"	G 1" 1/4	90	47	582	5	40
68559776B*	G 1" 1/4 F x G 1" 1/2 M	-	-	-	-	-	G 1" 1/4	G 1" 1/2	-	-	810	3	24
68559776R*	G 1" 1/4 F x G 1" 1/2 M	-	-	-	-	-	G 1" 1/4	G 1" 1/2	-	-	810	3	24

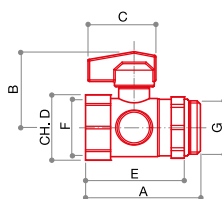

VCG 480

Valvola a sfera nichelata con maschio girevole e maniglia di colore blu o rosso.

CODICE	MISURA	A	B	C	D	E	F	G	H	L			
68559719B	G 1"	71	42	42	38	61	G 1"	G 1"	-	-	368	5	40
68559719R	G 1"	71	42	42	38	61	G 1"	G 1"	-	-	368	5	40

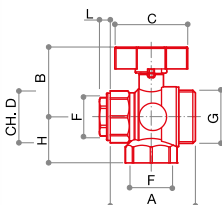

VCS 476

Valvola a sfera nichelata diritta e squadra senza bocchettone con maniglia di colore blu o rosso.

CODICE	MISURA	A	B	C	D	E	F	G	H	L			
68559711B	G 1" F x G 1" 1/4 M	66,5	55	62	38	-	G 1"	G 1" 1/4	36	9	510	5	40
68559711R	G 1" F x G 1" 1/4 M	66,5	55	62	38	-	G 1"	G 1" 1/4	36	9	510	5	40

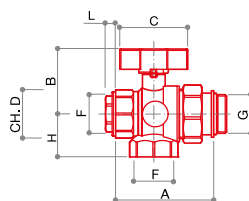

VCS 478

Valvola a sfera nichelata diritta e squadra con maniglia di colore blu o rosso e raccordo art. CR 498 con o-ring per attacco al collettore.

CODICE	MISURA	A	B	C	D	E	F	G	H	L			
68559715B	G 1"	82	55	62	38	-	G 1"	G 1"	36	9	658	5	40
68559715R	G 1"	82	55	62	38	-	G 1"	G 1"	36	9	658	5	40

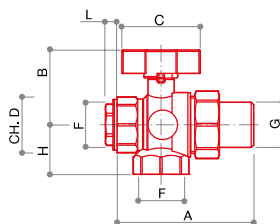

**VCS 477**

Valvola a sfera nichelata diritta e squadra con maniglia di colore blu o rosso e raccordo.

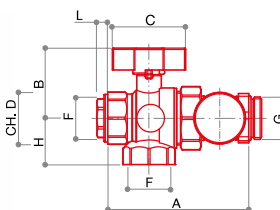
CODICE	MISURA	A	B	C	D	E	F	G	H	L			
68559713B	G 1"	99	55	62	38	-	G 1"	G 1"	36	9	684	5	40
68559713R	G 1"	99	55	62	38	-	G 1"	G 1"	36	9	684	5	40

**VCS 479**

Valvola a sfera nichelata diritta e squadra con maniglia di colore blu o rosso completa di termometro scala 0 °C ÷ 80 °C per collettori di serie CD.

CODICE	MISURA	A	B	C	D	E	F	G	H	L			
68559717B	G 1"	110	55	62	38	-	G 1"	G 1"	36	9	766	4	32
68559717R	G 1"	110	55	62	38	-	G 1"	G 1"	36	9	766	4	32

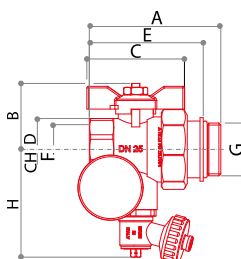
**VC 481**

Valvola a sfera multifunzione con scarico aria manuale, carico acqua, maniglia a farfalla di colore di colore blu o rosso e raccordo art. CR 498 con o-ring per attacco al collettore completa di termometro scala 0 °C ÷ 80 °C.

CODICE	MISURA	A	B	C	D	E	F	G	H	L			
68559722B	G 1"	81	41	60	38	70	G 1"	G 1"	70	-	645	4	32
68559722R	G 1"	81	41	60	38	70	G 1"	G 1"	70	-	645	4	32

VALVOLE BYPASS PER IMPIANTI RISCALDAMENTO



CARATTERISTICHE TECNICHE



Materiale parti
in ottone
CW614N



Guarnizioni OR
EPDM



Molla
AISI 302

FUNZIONALITÀ

L'utilizzo della valvola di bypass è necessario in tutti gli impianti di distribuzione dove sono presenti valvole di zona a 2 vie o corpi scaldanti muniti di valvole di regolazione che consentono in determinate condizioni, la completa esclusione del circuito. La valvola garantisce un ricircolo tale da impedire che la pompa sia utilizzata in condizioni lontane da quelle di progetto evitando sbilanciamenti dei circuiti funzionanti in parallelo e fastidiosi rumori dovuti all'aumento della velocità del fluido nell'attraversamento degli organi di regolazione stessi. La valvola di bypass VB 755 è stata studiata in particolare per essere facilmente impiegata sui collettori di distribuzione di nostra produzione e su una gamma di accessori per gli stessi. La valvola di bypass può essere montata su articoli assai diversi tra loro per i quali è richiesta solamente la presenza di due filetti da G 1/2 femmina contrapposti.

MONTAGGIO

Inserire la valvola di bypass tra la tubazione di andata e ritorno a valle della pompa di circolazione.

Come mostra il disegno la valvola è composta da 2 parti:

- sede valvola con raccordo per l'ingresso del fluido;
- elemento di regolazione con scala da 0,2 a 0,7 bar.

Attenzione: il raccordo deve essere montato solo dal lato di ingresso del fluido.

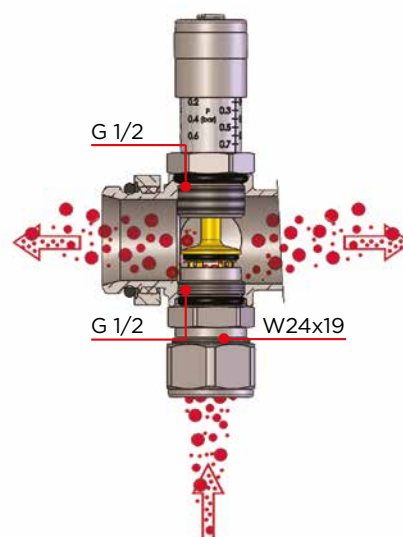
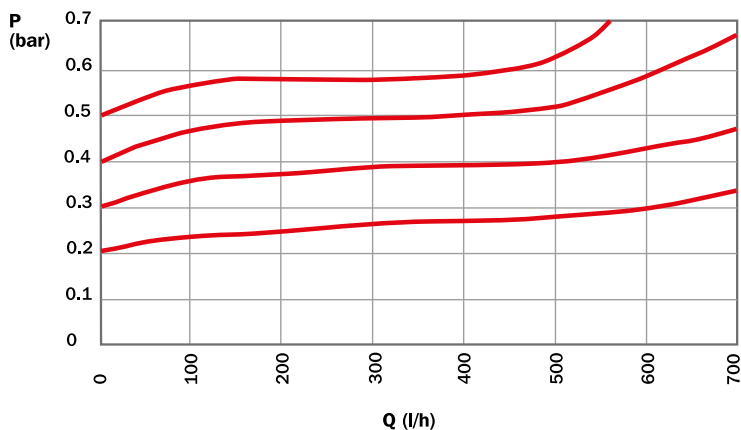

REGOLAZIONE

Ruotare la manopola fino a far coincidere il bordo della stessa con il valore desiderato riportato sulla scala graduata presente sul corpo della valvola.

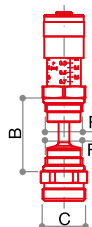



**VB 755**

Valvola di bypass.

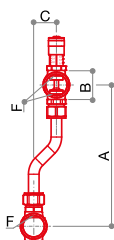
CODICE	MISURA	A	B	C	D	E	F	G	H	L			
68512109	CD G 1"	-	41	W24x19	-	-	G 1/2	-	-	-	158	10	80
68512110	CD G 1"1/4	-	51	W24x19	-	-	G 1/2	-	-	-	182	10	80



**VB 750**

Valvola di bypass.

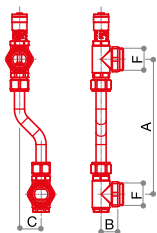
CODICE	MISURA	A	B	C	D	E	F	G	H	L			
68512101	CD G 1" x 200 mm	200	41	32	-	-	G 1/2	-	-	-	330	8	64
68512115	CD G 1" x 250 mm	250	41	32	-	-	G 1/2	-	-	-	350	8	64
68512102	CD G 1"1/4 x 200 mm	200	51	32	-	-	G 1/2	-	-	-	330	8	64



**VB 751**

Valvola di bypass con terminali per collettore.

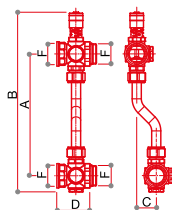
CODICE	MISURA	A	B	C	D	E	F	G	H	L			
68512103	G 1" x 200 mm	200	25	32	-	-	G 1"	-	-	-	400	5	40
68512116	G 1" x 250 mm	250	25	32	-	-	G 1"	-	-	-	420	4	32



**VB 752**

Valvola di bypass con bocchettoni per valvola a sfera con o senza termometro.

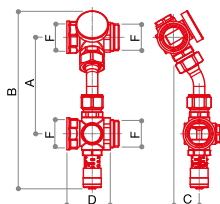
CODICE	MISURA	A	B	C	D	E	F	G	H	L			
68512105	G 1" x 200 mm	200	295	32	54	-	G 1"	-	-	-	766	3	24
68512117	G 1" x 250 mm	250	295	32	54	-	G 1"	-	-	-	820	3	24

**VB 753**

Valvola di bypass kit alta per GM 1192.

CODICE	MISURA	A	B	C	D	E	F	G	H	L			
68512108	G1"	120	223	32	54	-	G 1"	-	-	-	784	3	24

VALVOLE DI SCARICO ARIA



CARATTERISTICHE TECNICHE

Max temperatura	Max temperatura (valvole per sistema solare)	Max pressione	Max pressione di scarico
110 °C	200 °C	10 bar	6 bar

INSTALLAZIONE ED UTILIZZO

Le valvole di scarico aria serie VS hanno ottime caratteristiche di portata d'aria e sono indispensabili per liberare gli impianti idrotermici dall'eventuale presenza di bolle d'aria. Pur avendo una notevole capacità di portata d'aria, il loro ingombro è tale da consentirne l'utilizzo su caldaie murali a gas, su collettori ed ovunque si manifesti la necessità di liberare le condutture dalla presenza d'aria.

La valvola permette la completa evacuazione dell'aria in modo automatico oppure in modo manuale nelle relative tipologie.

La valvola deve essere installata in posizione verticale nei punti dell'impianto dove è favorito l'accumulo di bolle d'aria. Il funzionamento automatico avviene con il tappo in ottone allentato.

Se le valvole sfiato aria automatiche sono montate con la valvolina di ritegno VS 605 allora si potrà rimuoverle senza dover scaricare l'impianto.

Le valvole di sfiato aria automatiche esistono anche nella versione per impianti solari con una temperatura massima di utilizzo di 200 °C.

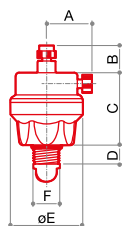

VS 602

Valvola automatica e manuale di sfogo aria tipo ridotto da G 3/8. Finitura nichelata.

CODICE	MISURA	A	B	C	D	E	F	G	H	L			
67790310N	G 3/8	25	15	40	10	40	G 3/8	-	-	-	148	15	120

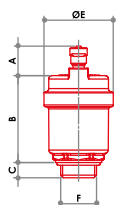

VS 604/A

Valvola automatica di sfogo aria.



CODICE	MISURA	FINITURA	A	B	C	D	E	F	G	H	L			
67790300	G 3/8	GIALLA	17	50	9	-	40	G 3/8	-	-	-	138	10	100
67790700	G 1/2	GIALLA	17	50	9	-	40	G 1/2	-	-	-	138	10	100
67790300N	G 3/8	NICHELATA	17	50	9	-	40	G 3/8	-	-	-	138	10	100
67790700N	G 1/2	NICHELATA	17	50	9	-	40	G 1/2	-	-	-	138	10	100

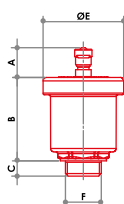

VS 601

Valvola di sfogo aria automatica tipo medio.

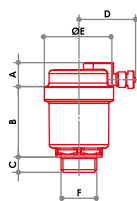

CODICE	MISURA	A	B	C	D	E	F	G	H	L			
67790117	G 3/8	17	50	9	-	46	G 3/8	-	-	-	154	10	100
67790121	G 1/2	17	50	9	-	46	G 1/2	-	-	-	154	10	100
67790127	G 3/4	17	50	9	-	46	G 3/4	-	-	-	154	10	100

**VS 603**

Valvola sfogo aria automatica con sfiato laterale.



Collaudo
100%

CODICE	MISURA	A	B	C	D	E	F	G	H	L			
67790417	G 3/8	14	41	9	34	40	G 3/8	-	-	-	160	10	100
67790421	G 1/2	14	41	9	34	40	G 1/2	-	-	-	160	10	100

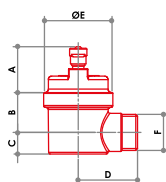
**VS 606**

Valvola di sfogo aria automatica con attacco laterale.



Collaudo
100%

CODICE	MISURA	A	B	C	D	E	F	G	H	L			
67790517	G 3/8	27	23	13	35	40	G 3/8	-	-	-	162	10	100
67790521	G 1/2	27	23	13	35	40	G 1/2	-	-	-	162	10	100

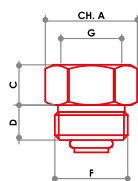
**VS 605**

Valvola di ritegno per valvola automatica di sfogo aria.

CODICE	MISURA	FINITURA	A	B	C	D	E	F	G	H	L			
67791200	G 3/8F x G 3/8M	GIALLA	19	-	12	9	-	G 3/8	G 3/8	-	-	18	100	800
67791400	G 3/8F x G 1/2M	GIALLA	23	-	12	9	-	G 1/2	G 3/8	-	-	40	100	800
67791600	G 1/2F x G 1/2M	GIALLA	23	-	12	9	-	G 1/2	G 1/2	-	-	30	100	800
67791200N	G 3/8F x G 3/8M	NICHELATA	19	-	12	9	-	G 3/8	G 3/8	-	-	18	100	800
67791400N	G 3/8F x G 1/2M	NICHELATA	23	-	12	9	-	G 1/2	G 3/8	-	-	40	100	800
67791600N	G 1/2F x G 1/2M	NICHELATA	23	-	12	9	-	G 1/2	G 1/2	-	-	30	100	800

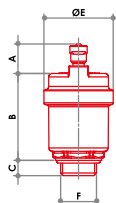
**VS 604/S**

Valvola sfogo aria automatica.
200°C - 10 bar.



Collaudo
100%

CODICE	MISURA	A	B	C	D	E	F	G	H	L			
67791017	G 3/8	17	50	9	-	40	G 3/8	-	-	-	138	10	100
67791021	G 1/2	17	50	9	-	40	G 1/2	-	-	-	138	10	100

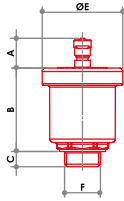

VS 601/S

Valvola di sfogo aria automatica tipo medio. 200°C - 10 bar.



Collaudo 100%

CODICE	MISURA	A	B	C	D	E	F	G	H	L			
67790817	G 3/8	17	50	9	-	46	G 3/8	-	-	-	154	10	100
67790821	G 1/2	17	50	9	-	46	G 1/2	-	-	-	154	10	100
67790827	G 3/4	17	50	9	-	46	G 3/4	-	-	-	154	10	100

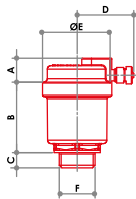

VS 603/S

Valvola sfogo aria automatica con sfiato laterale. 200°C - 10 bar.



Collaudo 100%

CODICE	MISURA	A	B	C	D	E	F	G	H	L			
67790917	G 3/8	14	41	9	34	40	G 3/8	-	-	-	160	10	100
67790921	G 1/2	14	41	9	34	40	G 1/2	-	-	-	160	10	100

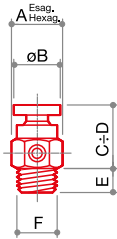

VS 610

Valvolina manuale per sfogo aria con volantino in ottone.



Collaudo 100%

CODICE	MISURA	A	B	C	D	E	F	G	H	L			
67793000	G 1/8	13	14	20	23	7	G 1/8	-	-	-	20	100	800
67793500	G 1/4	13	14	17	19	7	G 1/4	-	-	-	20	100	800
67794000	G 3/8	16	14	17	19	7	G 3/8	-	-	-	30	100	800

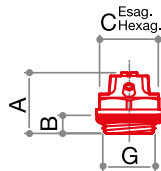

VS 620

Valvolina manuale per sfogo aria con parte superiore in ABS colore bianco, o-ring di tenuta sul filetto, con possibilità di rotazione dello scarico.



Collaudo 100%

CODICE	MISURA	A	B	C	D	E	F	G	H	L			
67795417	G 3/8	21	7	19	-	-	-	G 3/8	-	-	21	100	800
67795421	G 1/2	21	8	22	-	-	-	G 1/2	-	-	24	100	800



CH 620

Chiave a farfalla per valvolina VS 620.

CODICE	MISURA			
67795400	-	1	200	-

VALVOLE DI SICUREZZA



CARATTERISTICHE TECNICHE

			
Campo di temperatura	Pressione di esercizio	Sovrappressione apertura	Scarto di chiusura
5 ÷ 110 °C	secondo taratura	20%	20%

CARATTERISTICHE COSTRUTTIVE

Le valvole di sicurezza vengono utilizzate per il controllo della pressione sui generatori di calore negli impianti di riscaldamento, sugli accumuli di acqua calda negli impianti idrosanitari e negli impianti idrici. La valvola si apre quando viene raggiunta la pressione di taratura e, tramite lo scarico in atmosfera, impedisce alla pressione dell'impianto di raggiungere limiti pericolosi per i componenti presenti nell'impianto stesso.

PRINCIPIO DI FUNZIONAMENTO

L'otturatore è in contrasto con una molla tarata in acciaio C72 che viene precaricata in base alla pressione di taratura, scelta in funzione della massima pressione ammissibile nell'impianto. Questo otturatore si solleva al raggiungimento della pressione di taratura e apre completamente il passaggio di scarico, mentre al diminuire della pressione si ha l'azione inversa, con la chiusura della valvola entro le tolleranze imposte. Il diametro dell'attacco in uscita della valvola deve essere uguale o maggiore per facilitare lo scarico della potenzialità richiesta. Le valvole di sicurezza ordinarie, secondo le normative italiane, possono essere applicate su generatori con potenzialità inferiore a 35 kW.



INSTALLAZIONE

Le valvole di sicurezza possono essere montate in posizione verticale od orizzontale ma non capovolte per evitare che si possa depositare delle impurità che causerebbero un cattivo funzionamento. Le valvole di sicurezza devono essere installate sulla sommità del generatore o sulla tubazione di mandata più vicina possibile al generatore, oppure entro la distanza massima dove specificata dalle normative applicabili. La tubazione di collegamento della valvola di sicurezza al generatore non deve essere intercettabile. Prima dell'installazione di una valvola di sicurezza è necessario che ne sia eseguito un corretto dimensionamento secondo le normative vigenti per le specifiche applicazioni. È vietato farne utilizzo diverso rispetto alla sua destinazione d'uso. L'installazione delle valvole di sicurezza deve essere eseguita da parte di personale tecnico qualificato secondo la normativa vigente. La valvola di sicurezza deve essere installata rispettando il senso di flusso indicato dalla freccia riportata sul corpo valvola.



VS 910

Valvola di sicurezza ordinaria a membrana 1/2 x 1/2 F/F.

CODICE	MISURA	bar			
67795001	1/2 x 1/2 F/F	1,5	110	10	100
67795002		1,8	110	10	100
67795003		2	110	10	100
67795004		2,5	110	10	100
67795005		3	110	10	100
67795006		3,5	110	10	100
67795007		4	110	10	100
67795008		5	110	10	100
67795009		6	110	10	100
67795010		7	110	10	100
67795011		8	110	10	100
67795012		10	110	10	100



VS 911

Valvola di sicurezza ordinaria a membrana 1/2 x 1/2 M/F.

CODICE	MISURA	bar			
67795014	1/2 x 1/2 M/F	1,5	120	10	100
67795015		1,8	120	10	100
67795016		2	120	10	100
67795017		2,5	120	10	100
67795018		3	120	10	100
67795019		3,5	120	10	100
67795020		4	120	10	100
67795021		5	120	10	100
67795022		6	120	10	100
67795023		7	120	10	100
67795024		8	120	10	100
67795025		10	120	10	100



**VS 920**

Valvola di sicurezza ordinaria a membrana 3/4 x 3/4 F/F.

CODICE	MISURA	bar			
67795027	3/4 x 3/4 F/F	1,5	170	10	100
67795028		1,8	170	10	100
67795029		2	170	10	100
67795030		2,5	170	10	100
67795031		3	170	10	100
67795032		3,5	170	10	100
67795033		4	170	10	100
67795034		6	170	10	100
67795035		7	170	10	100
67795036		8	170	10	100
67795037	10	170	10	100	



**VS 930**

Valvola di sicurezza ordinaria a membrana 1" x 1" F/F.

CODICE	MISURA	bar			
67795039	1" x 1" F/F	1,5	250	10	100
67795040		1,8	250	10	100
67795041		2,5	250	10	100
67795042		3	250	10	100
67795043		4	250	10	100
67795044		6	250	10	100



**VS 912**

Valvola di sicurezza ordinaria a membrana 1/2 x 1/2 F/F con attacco da 1/4 per manometro.

CODICE	MISURA	bar			
67795046	1/2 x 1/2 F/F	1,5	130	10	100
67795047		1,8	130	10	100
67795048		2	130	10	100
67795049		2,5	130	10	100
67795050		3	130	10	100
67795051		3,5	130	10	100
67795052		4	130	10	100
67795053		6	130	10	100

**VS 913**

Valvola di sicurezza ordinaria a membrana 1/2 x 1/2 M/F con attacco da 1/4 per manometro.

CODICE	MISURA	bar			
67795055	1/2 x 1/2 M/F	1,5	135	10	100
67795056		1,8	135	10	100
67795057		2	135	10	100
67795058		2,5	135	10	100
67795059		3	135	10	100
67795060		3,5	135	10	100
67795061		4	135	10	100
67795062		6	135	10	100

VALVOLA MISCELATRICE TERMOSTATICA



CARATTERISTICHE TECNICHE



Max temperatura
in ingresso
85 °C



Max pressione
statica
10 bar



Max pressione
dinamica
5 bar



Max pressione
differenziale tra
gli ingressi
0.5 bar



Intervallo di
regolazione
30 °C ÷ 65 °C



Tolleranza di
regolazione
± 2 °C



Materiale parti
stampate
CW617N
UNI EN
12165:2016



Materiale parti
acciaio inox
AISI 302



Guarnizioni OR
EPDM

CARATTERISTICHE COSTRUTTIVE

Le parti stampate sono in ottone a basso contenuto di piombo in conformità con le normative CW617N UNI EN 12165:2016. Tutte le guarnizioni o-rings sono in EPDM perossidico. Le parti in acciaio inox sono in AISI 302. Elemento termosensibile in cera.

IMPIEGO

La valvola miscelatrice termostatica è in grado di mantenere costante, per mezzo di un elemento termostatico, il valore impostato dell'acqua di utilizzo a fronte di variazioni di pressione e di temperatura agli ingressi.

Il suo utilizzo assume una grande importanza negli impianti di distribuzione di acqua calda sanitaria, nei quali si deve impedire che acqua ad elevata temperatura, proveniente da caldaie, boiler, ecc. possa causare ustioni agli utenti.

La valvola miscelatrice è fornita con un dispositivo antiscottatura integrato che blocca immediatamente il flusso in caso la pressione dell'acqua a bassa temperatura crolli.

Dado blocco manopola
Handle locking nut

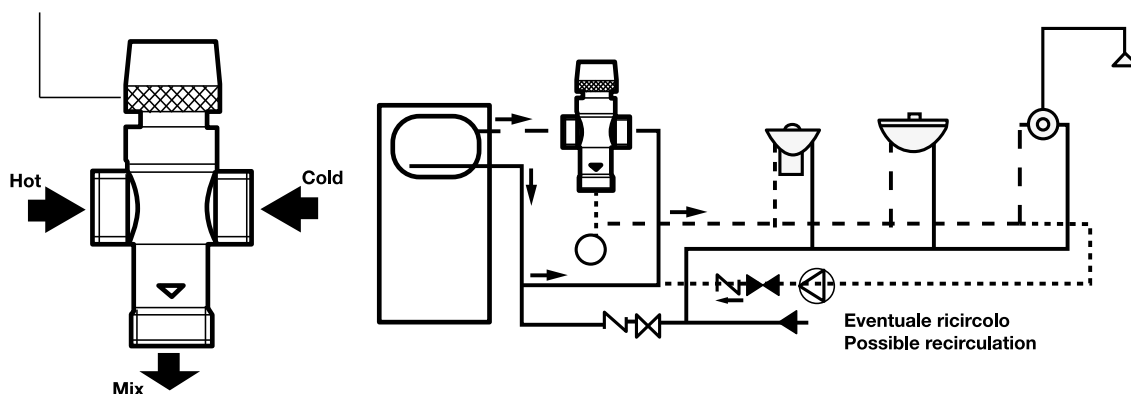

FUNZIONAMENTO

La valvola miscelatrice termostatica può essere installata in posizione verticale o orizzontale, senza alcuna limitazione.

Rispettare le connessioni indicate sul corpo e in figura:

- Hot (H) bollino rosso: Acqua Calda
- Cold (C) bollino blu: Acqua Fredda
- Mix: Acqua Miscelata

Se la pressione dell'acqua è superiore ai 5 bar si consiglia di montare un riduttore di pressione.

Se la pressione dell'acqua calda e fredda è sensibilmente differente si consiglia di montare sugli ingressi delle valvole di ritegno.

Se l'acqua delle alimentazioni contiene delle impurità si consiglia di installare dei filtri art. RF 5008.

La valvola ha la possibilità di bloccare la temperatura imposta semplicemente avvitando il dado verso il corpo sulla vite posta sotto la manopola per evitare manomissioni.

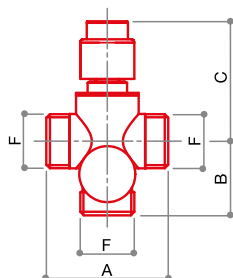

VM 660

Valvola miscelatrice termostatica con miscelazione sulla terza via.
Sensore a cera integrato con campo di regolazione 30 °C ÷ 65 °C. Conforme al D.M. 174/2004.



CODICE	MISURA	A	B	C	D	E	F	G	H	L	🔧	📦	📦
68753420	G 1"	74	45	65	-	-	G 1"	-	-	-	690	1	-

VALVOLA MISCELATRICE



IMPIEGO

La valvola a tre vie VM 652 può essere impiegata come valvola deviatrice o miscelatrice per impianti di riscaldamento e condizionamento con utilizzo di acqua o soluzione acquaglicole **max** 30%. La valvola VM 650 è costruita per l'impiego specifico nei sistemi di riscaldamento a pannello radiante. Il suo funzionamento è simile a quello di una valvola termostatica a 2 vie con il bypass aperto sul ritorno del pannello radiante. La via B-AB è sempre aperta. Le valvole a tre vie serie VM sono normalmente aperte e possono essere impiegate con la testa termostatica art TT 2351 come miscelatrici a punto fisso in impianti di riscaldamento o comandate elettricamente con teste serie TE e motori serie SM.

PECULIARITÀ

Le valvole serie VM presentano:

- Elevati valori di Kvs.
- Possibilità di una precisa modulazione grazie alla corsa e alla forma dell'otturatore, che consente di aprire immediatamente sia il passaggio diretto che il bypass, garantendo una modulazione dei flussi in un campo pari all'intera corsa. (VM 652)
- Bassissimo trafilemento anche se utilizzate in impianti con alta pressione differenziale.

CARATTERISTICHE TECNICHE

Max trafilemento ammesso con ΔP max

- 0.05% del Kvs per il passaggio diretto
- 0.1% del Kvs per il bypass

Kvs attraverso il bypass inferiore del 30% circa del passaggio diretto

Via A-AB portata Kvs 3.5 - Massima ΔP ammesso 0.8 bar

Via B-AB portata Kvs 2.6 - Massima ΔP ammesso 1.8 bar



Max temperatura

120 °C



Max pressione

16 bar



Materiale parti stampate
CW617N
UNI EN
12165:2016



Materiale otturatore
CW614N
UNI EN
12164:2016



Materiale parti acciaio inox
AISI 303



Guarnizioni OR
EPDM

FUNZIONAMENTO

Le valvole miscelatrici VM 650-652 possono essere installate in posizione verticale o orizzontale, senza alcuna limitazione. Rispettare le connessioni indicate sul corpo e in figura.

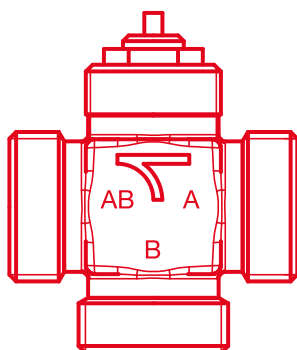

VM 650		VM 652			
MISCELATRICE		MISCELATRICE		DEVIATRICE	
A	ingresso fluido 1	A	ingresso fluido 1	AB	ingresso fluido
B	ingresso fluido 2	B	ingresso fluido 2	A	uscita fluido 1
AB	miscelato (via B-AB di bypass)	AB	miscelato	B	uscita fluido 2
Kvs (m³/h)		Kvs (m³/h)		Kvs (m³/h)	
A-AB = 3,5		A-AB = 3,5		AB-A = 3,9	
B-AB = 2,6		B-AB = 2,6		AB-B = 2,8	
ΔP MAX (bar)		ΔP MAX (bar)		ΔP MAX (bar)	
A-AB = 0,8		A-AB = 0,8		AB-A = 3,5	
B-AB = -		B-AB = 1,8		AB-B = 1	

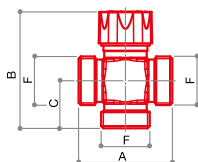

VM 650

Valvola miscelatrice termostattabile con miscelazione laterale e terza via di bypass.

CODICE	MISURA	A	B	C	D	E	F	G	H	L	⚙️	📦	📦
68753411	G 1"	64	80	35	-	-	G 1"	-	-	-	346	1	30

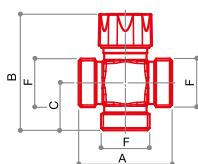

VM 652

Valvola miscelatrice termostattabile con miscelazione laterale.

CODICE	MISURA	A	B	C	D	E	F	G	H	L	⚙️	📦	📦
68753413	G 1"	64	80	35	-	-	G 1"	-	-	-	260	1	30

VALVOLE DEVIATRICI DI ZONA



CARATTERISTICHE COSTRUTTIVE

Le valvole deviatrici di zona VZ sono in ottone, robuste e realizzate appositamente per essere automatizzate facilmente e velocemente con attuatori elettrici, compatte, in grado di essere posizionate anche in cassette con una profondità di 80mm.

CARATTERISTICHE TECNICHE



Limiti di temperatura
(valvola)
-20 °C ÷ +130 °C



Limiti di temperatura
(attuatore)
-20 °C ÷ +70 °C



Pressione di
esercizio
secondo modello

SCHEMI IDRAULICI

VZ702

Schema a tre vie bypass

POSIZIONE 1

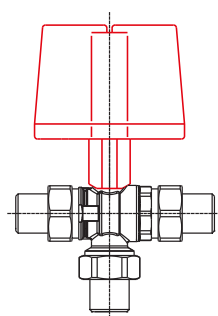
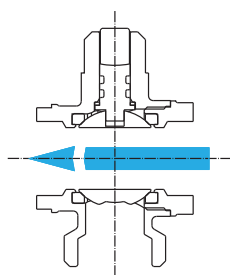

POSIZIONE 2

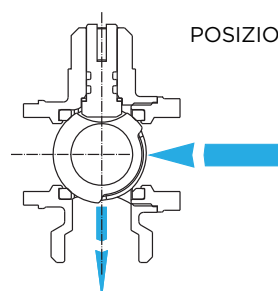

DIAGRAMMI DI PORTATA

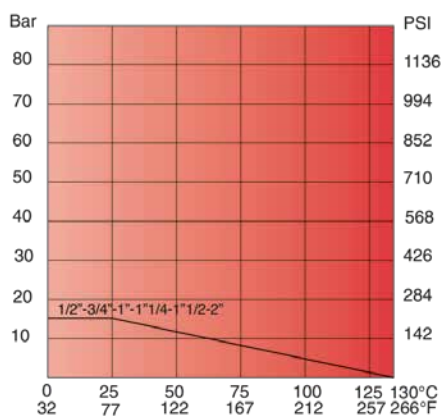
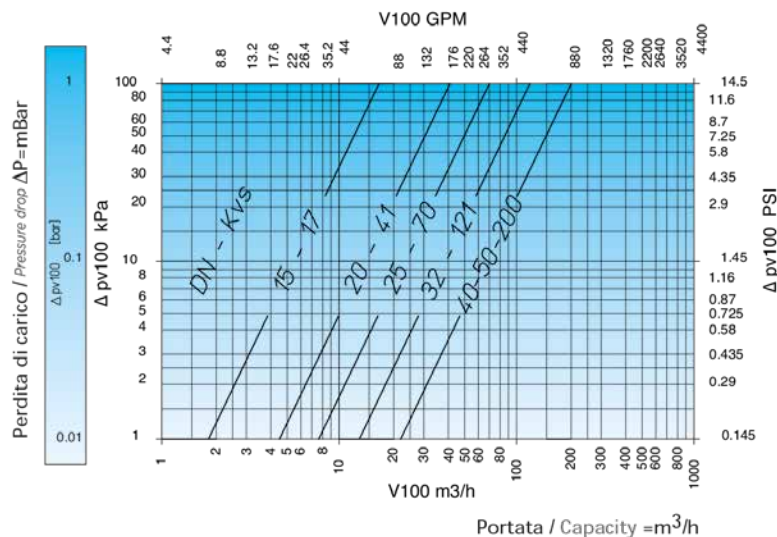
DIAGRAMMA PRESSIONE / TEMPERATURA
(prova eseguita con acqua)DIAGRAMMA PERDITA DI CARICO
(per uso con H₂O)

CARATTERISTICHE ATTUATORE

Corpo e coperchio	Nylon 6
Voltaggio	230V 50-60Hz
Potenza assorbita	3,5 Watt
Segnale ingresso	2 Punti / SPST / On-Off / con relè interno
Coppia Motrice	13 Nm max
Attacco per valvole	Quick Mounting (Attacco rapido)
Tempo di azionamento	60 Sec / 90°

Tipologia di motore	Bidirezionale
Angolo di rotazione	90°
Grado di protezione	IP54
Temperatura di esercizio	-20 / +70 °C
Connessione	Cavo multifilare 6 fili
Segnale di uscita	230V 50-60Hz 200VA
Contatto ausiliario	250V 10A (AC1)

COLLEGAMENTI ELETTRICI

SM700

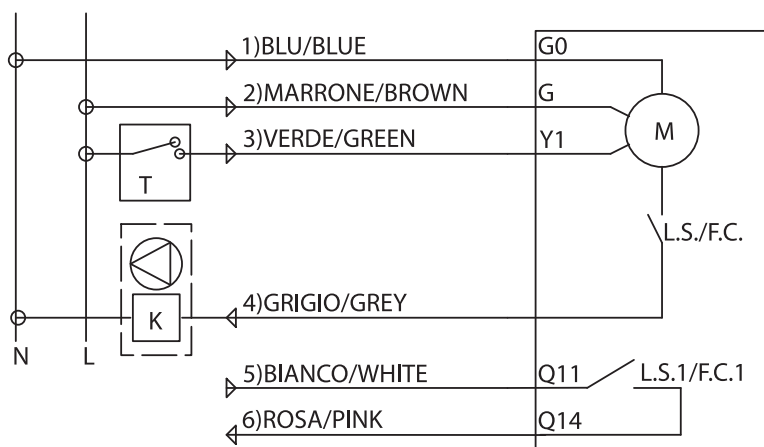



- 1 BLU** - NEUTRO 230V 50/60Hz
2 MARRONE - FASE 230V 50/60Hz (3,5W)
3 VERDE - FASE PER APRIRE / NO FASE PER CHIUDERE
4 GRIGIO - FASE CON VALVOLA APERTA
5 BIANCO - COMUNE CONTATTO AUSILIARIO
6 ROSA - N.O. CONTATTO AUSILIARIO

- N** - NEUTRO (SN)
L - FASE (SP)
T - TERMOSTATO AMBIENTE
K - RELÈ POMPA RICIRCOLO
F.C. - FINE CORSA 230VAC 10A (AC1)
F.C.1 - CONTATTO AUSILIARIO 250VAC 10A (AC1)
M - MOTORE

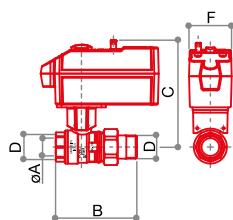
COLORE FILI	DIREZIONE	DESCRIZIONE	CONNESSIONE
1 BLU	IN	Neutro	Collegare al neutro della linea di alimentazione
2 MARRONE	IN	Fase	Collegare alla fase della linea di alimentazione
3 VERDE	IN	Apertura / Chiusura	Collegare il filo verde alla fase della linea di alimentazione per aprire la valvola
4 GRIGIO	OUT	Uscita In Tensione	Quando la valvola è aperta, presenza della fase sul filo grigio
5 BIANCO	COMUNE	Fine Corsa Ausiliario	Comune del contatto ausiliario
6 ROSA	OUT	Fine Corsa Ausiliario	N.O. del contatto ausiliario



**VZ 700**

Valvola di zona F-M con servomotore elettrico compatto.

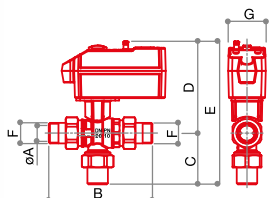
CODICE	MISURA	A	B	C	D	E	F	G	H	L			
68812700	G 3/4	20	92	121	G 3/4	-	48	-	-	-	1250	1	-
68813400	G 1"	25	105	127	G 1"	-	48	-	-	-	1430	1	-
68814200	G 1 1/4	32	123	133	G 1 1/4	-	48	-	-	-	1720	1	-



**VZ 702**

Valvola di zona a 3-vie, 3° via in bypass, con servomotore elettrico compatto.

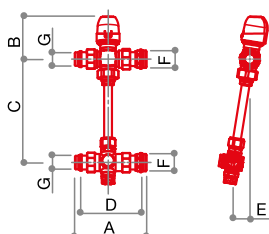
CODICE	MISURA	A	B	C	D	E	F	G	H	L			
68822700	G 3/4	20	133	66	118	183	G 3/4	48	-	-	1480	1	-
68823400	G 1"	25	151	70	122	192	G 1"	48	-	-	1950	1	-

**VZ 712**

Kit di deviazione per collettori serie CD con valvola di intercettazione sul bypass. Portata massima consigliata 1800 l/h (Kv 3.5).

CODICE	MISURA	A	B	C	D	E	F	G	H	L			
68763603	G 1"	138	83	200	118	32	G 1"	G 3/4	-	-	1400	1	8

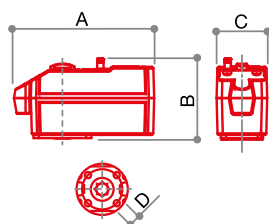
**SM 700**

Servomotore elettrico per valvole di zona VZ 700 e VZ 702.

CODICE	MISURA	A	B	C	D	E	F	G	H	L			
69011720	230 V - ON/OFF	133	68	48	9	-	-	-	-	-	480	1	-

DEMAX

DEFANGATORE MAGNETICO PER IMPIANTI DI RISCALDAMENTO



**CATTURA LE IMPURITÀ
ED EVITA OSTRUZIONI**

Le tematiche connesse al risparmio energetico e all'utilizzo razionale delle risorse sono sempre più di maggior attualità; per cui si rende necessario mantenere efficiente il circuito di riscaldamento utilizzando un filtro defangatore magnetico posto sul condotto di ritorno per catturare le impurità presenti nel fluido termovettore ed evitando eventuali danneggiamenti che queste possono provocare all'impianto di riscaldamento. Questo dispositivo deve essere installato sul circuito di riscaldamento e una volta posizionato, è necessario effettua-

re nuovamente il riempimento dell'impianto di riscaldamento sfogando l'aria in eccesso.

Le principali caratteristiche tecniche sono:

- Evita il pericolo di formazione di ostruzioni ed intasamenti delle tubazioni circuito di riscaldamento e dei suoi componenti.
- Nel caso di sostituzione della caldaia, il filtro defangatore è applicabile anche su quella nuova.

CARATTERISTICHE TECNICHE



Max temperatura
65 °C



Temperatura ambiente
+5°C ...+ 50°C



Pressione di esercizio acqua:
1,0 ÷ 2,0 bar



Pressione massima acqua:
3,0 bar

Contenuto di acqua circuito riscald.: ~ 0,2 l

Magnete: Ø12x60 mm, 4500 gauss

Larghezza: 101,5 mm

Altezza: 116,5 mm

Peso a vuoto: 175 g

Raccorderia in dotazione: G3/4

SCHEMA DI FUNZIONAMENTO

Il filtro defangatore prevede due diverse configurazioni di installazione per potersi adattare alla maggioranza dei circuiti idraulici domestici esistenti oppure nuovi.

- 1) Ritorno impianto riscaldamento / ingresso filtro
- 2) Uscita filtro defangatore / verso ritorno caldaia
- 3) Sede per tappo cieco G3/4 femmina
- 4) Sede per tappo cieco M12 in plastica grigia per svuotamento filtro.

**Configurazione
con filtro in orizzontale**

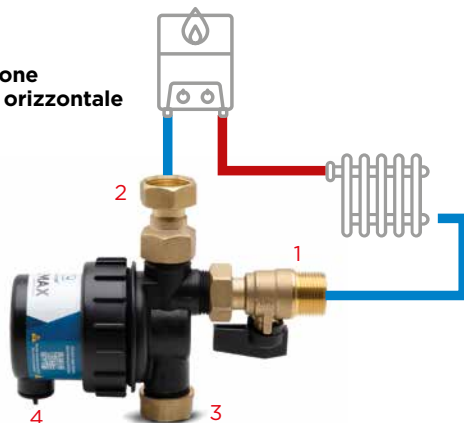

**Configurazione
con filtro in verticale**



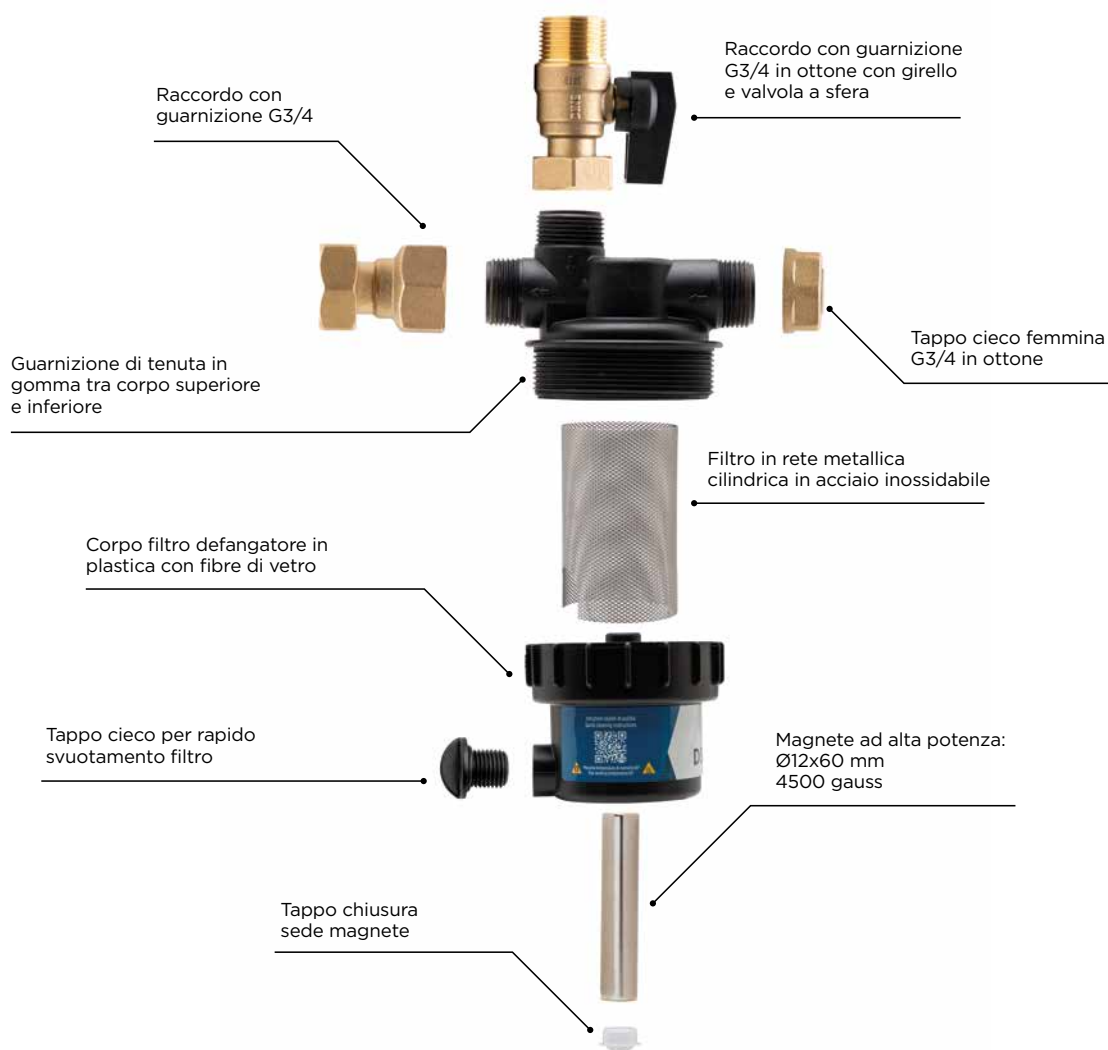

PRINCIPIO DI FUNZIONAMENTO

L'acqua di ritorno dall'impianto di riscaldamento, viene collegata al raccordo d'ingresso del filtro defangatore, successivamente l'acqua attraversa la zona interna dove è presente il magnete e la rete metallica in acciaio inossidabile ed esce dal raccordo di uscita del filtro defangatore.

DEFANGATORE MAGNETICO PER IMPIANTI DI RISCALDAMENTO



DM 2018

Defangatore magnetico per impianti di riscaldamento.

CODICE	MISURA			
68550010	G 3/4	542	1	6



4 / GRUPPI PREMONTATI

SISTEMI DI REGOLAZIONE PER IMPIANTI A PANNELLI RADIANTI CON IL GRUPPO POMPA GP 1190



20 kW

CARATTERISTICHE TECNICHE

Pressione massima di esercizio 6 bar
Pressione massima differenziale 1 bar
Temperatura massima di esercizio 120 °C

CARATTERISTICHE TECNICHE SISTEMA CON GP 1190

Pressione massima di esercizio 6 bar
Pressione massima differenziale 1 bar
Temperatura massima di esercizio 70 °C
Intervallo di temperatura sul secondario 20 °C ÷ 65 °C
Potenza termica massima 20 kW con un Δt di 10 °C e temperatura del primario ≥ 70 °C

CARATTERISTICHE COSTRUTTIVE

Le parti stampate sono in ottone a basso contenuto di piombo in conformità con le normative CW617N UNI EN 12165:2016. Tutte le guarnizioni o-ring sono in EPDM perossidico. Le parti in acciaio inox sono in AISI 316. Tutti i componenti sono dotati di tenuta morbida o-ring, non necessitano di alcun elemento intermedio di sigillatura (es. PTFE, canapa, ecc).

Attacchi laterali da W24x19 o da G 3/4 Ek con interassi da 50 mm. Il gruppo pompa GP 1190 ha un passaggio interno pari a un Ø 23 mm.

IMPIEGO

Il sistema per il riscaldamento a punto fisso ha il vantaggio di essere particolarmente compatto e di sfruttare tutti i componenti di serie dei collettori Luxor già in commercio e già noti, con l'aggiunta di 2 soli articoli specifici:

- art. GP 1190;
- art. TT 3051.

Questo sistema permette di ottenere, in maniera semplice e conveniente, un impianto di riscaldamento misto in quelle unità abitative dove sono presenti sia corpi scaldanti ad alta temperatura (60 °C ÷ 70 °C), sia circuiti a pannelli radianti da alimentare con acqua a bassa temperatura (20 °C ÷ 50 °C).

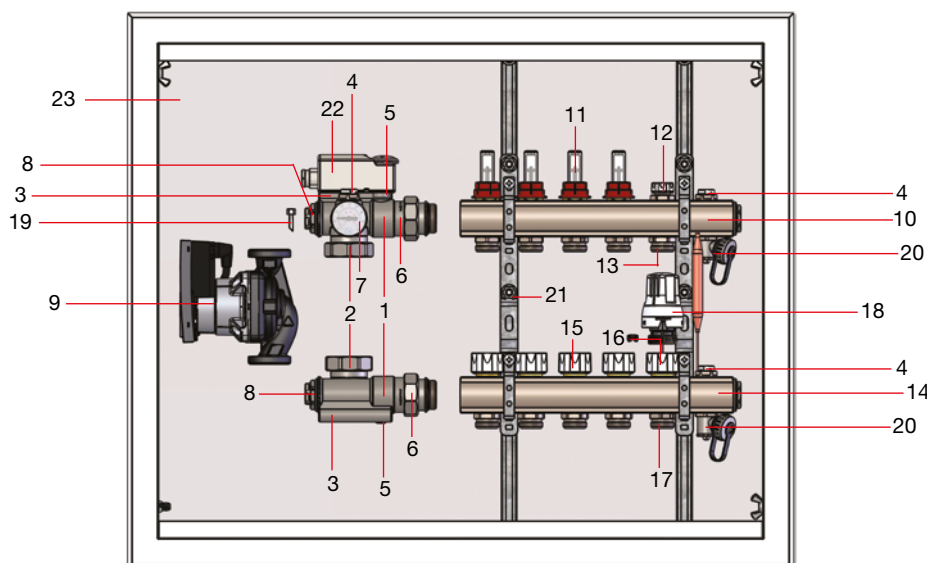





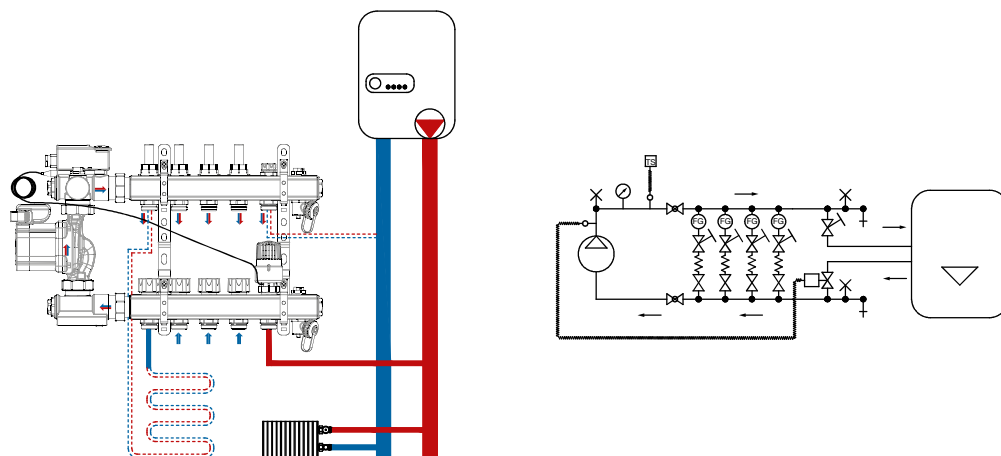



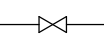

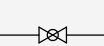

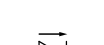

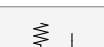
COMPONENTI

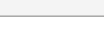
- 1 Gruppo pompa
- 2 Collegamenti alla pompa di circolazione con dado girevole da G 1"1/2
- 3 Alloggiamenti per la sonda di regolazione della testa termostatica e predisposizione per l'alloggiamento del sensore del termostato di sicurezza
- 4 Valvola di sfogo aria manuale
- 5 Valvole a sfera per l'intercettazione della pompa
- 6 Raccordi da G 1" con tenuta morbida
- 7 Termometro per la rilevazione delle temperatura impostata
- 8 Attacchi da G 1/2 femmina per eventuali strumenti
- 9 Pompa di circolazione con motore sincrono 25/60 interasse 130 mm in classe energetica A
- 10 Collettore di mandata ai pannelli radianti
- 11 Regolatori e misuratori di portata, con capacità da 0,5 l/min a 5 l/min. In caso lo sporco impedisce la lettura della portata, è possibile smontare e pulire il bicchiere con l'impianto in funzione
- 12 Valvola di intercettazione del circuito a bassa temperatura
- 13 Attacco per il ritorno in caldaia
- 14 Collettore di ritorno dei pannelli radianti
- 15 Valvole predisposte per la regolazione elettrotermica con cappucci di protezione
- 16 Valvola di regolazione termostaticabile
- 17 Attacco mandata dalla caldaia
- 18 Testa termostatica con sensore a distanza
- 19 Molla per il fissaggio della sonda a distanza della testa termostatica
- 20 Rubinetto di carico e scarico acqua
- 21 Staffe
- 22 Termostato di sicurezza bimetallico a contatto
- 23 Cassetta con piedi regolabili, cornice e porta bianchi RAL 9016

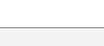

LEGENDA SCHEMI IDRAULICI

	valvola intercettazione		rubinetto di carico o scarico acqua		pompa circolazione
	valvola sfera		termometro		utilizzatore: pannelli radianti, termoarredi ecc.
	valvola non ritorno, la freccia indica il senso di flusso		dispositivo di sfogo aria manuale		filtro
	valvola di sicurezza (valvola di bypass)		dispositivo di sfogo aria automatico		valvola a 3 vie
	valvola intercettazione, regolazione e bilanciamento		misuratore di portata		
	valvola a sfera d'intercettazione, regolazione e bilanciamento		termostato di sicurezza ad immersione		
	valvola di iniezione con sensore a distanza		termostato di sicurezza a contatto		

FUNZIONAMENTO

Il sistema per il riscaldamento a punto fisso mantiene costante a un valore impostato la temperatura dell'acqua nei pannelli radianti, miscelando l'acqua ad alta temperatura in arrivo dalla caldaia con quella in circolazione nei pannelli stessi.

Una valvola termostatica con sonda a distanza rileva la temperatura e, in base al valore rilevato, integra il circuito di una quantità di acqua ad alta temperatura, tale da compensare la potenza termica ceduta dai pannelli radianti.

Si consiglia comunque di montare sulla valvola in ingresso alla pompa un termostato di sicurezza, al fine di evitare danni dovuti a un innalzamento imprevisto della temperatura.

L'intervento del termostato di sicurezza deve bloccare il funzionamento della pompa.

Il sistema può essere integrato con una valvola di bypass che, in presenza di una eccessiva pressione differenziale, scarichi la prevalenza in esubero salvaguardando i componenti dell'impianto e, nel caso siano utilizzate teste termoelettriche per l'intercettazione dei circuiti, eviti fenomeni di rumore e usura della pompa di circolazione.

Questo tipo di impianto riesce a fornire una potenza termica massima di 20 kW con un Δt di 10°C e una temperatura del primario ≥ 70 °C.

SISTEMI DI REGOLAZIONE PER IMPIANTI A PANNELLI RADIANTI CON IL GRUPPO POMPA GP 1190



GP 1190

Valvola da G 1" attacco pompa per sistema di riscaldamento misto, temperatura massima del termometro 80 °C.

CODICE	MISURA			
72000030	G 1"	2107	1	8



Profondità 90 mm

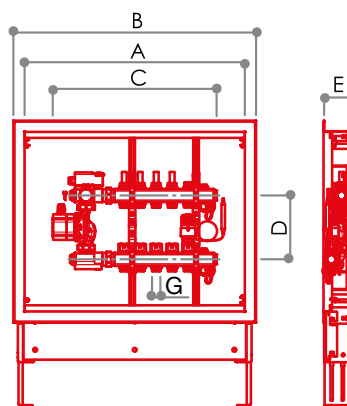

CCBP 4022

Impianto con distribuzione a punto fisso bassa (W24x19).

ARTICOLO	CODICE	MISURA	N. ATTACCHI PANNELLI	A	B	C	D	E	F	G	H	L		
CCBP4022/2	17402202N	G 1" x (W24x19)	2	500	560	420	200	90	-	W24x19	-	-	17,312	1
CCBP4022/3	17402203N		3	700	760	470			-		-	19,906	1	
CCBP4022/4	17402204N		4	700	760	520			-		-	20,500	1	
CCBP4022/5	17402205N		5	700	760	570			-		-	21,094	1	
CCBP4022/6	17402206N		6	700	760	620			-		-	21,688	1	
CCBP4022/7	17402207N		7	850	910	670			-		-	24,282	1	
CCBP4022/8	17402208N		8	850	910	720			-		-	24,876	1	
CCBP4022/9	17402209N		9	850	910	770			-		-	25,470	1	
CCBP4022/10	17402210N		10	1000	1060	820			-		-	28,064	1	
CCBP4022/11	17402211N		11	1000	1060	870			-		-	28,658	1	

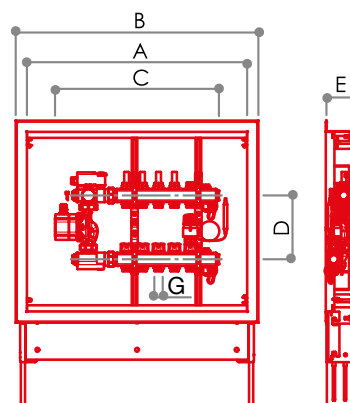
**CCBP 4032**

Impianto con distribuzione a punto
fisso bassa G 3/4 EK.



ARTICOLO	CODICE	MISURA	N. ATTACCHI PANNELLI	A	B	C	D	E	F	G	H	L		
CCBP4032/2	17403202N	G 1" x G 3/4 EK	2	500	560	420	200	90	-	G 3/4 EK	-	-	17,312	1
CCBP4032/3	17403203N		3	700	760	470			-		-	19,906	1	
CCBP4032/4	17403204N		4	700	760	520			-		-	20,500	1	
CCBP4032/5	17403205N		5	700	760	570			-		-	21,094	1	
CCBP4032/6	17403206N		6	700	760	620			-		-	21,688	1	
CCBP4032/7	17403207N		7	850	910	670			-		-	24,282	1	
CCBP4032/8	17403208N		8	850	910	720			-		-	24,876	1	
CCBP4032/9	17403209N		9	850	910	770			-		-	25,470	1	
CCBP4032/10	17403210N		10	1000	1060	820			-		-	28,064	1	
CCBP4032/11	17403211N		11	1000	1060	870			-		-	28,658	1	

DIAGRAMMA DI PORTATA



Kv	Kv Δt 2 °C	POS
1,92	00.29	1

SISTEMI DI REGOLAZIONE PER IMPIANTI A PANNELLI RADIANTI CON IL GRUPPO POMPA GP 1190 E KIT PER ALTA TEMPERATURA KA 1191

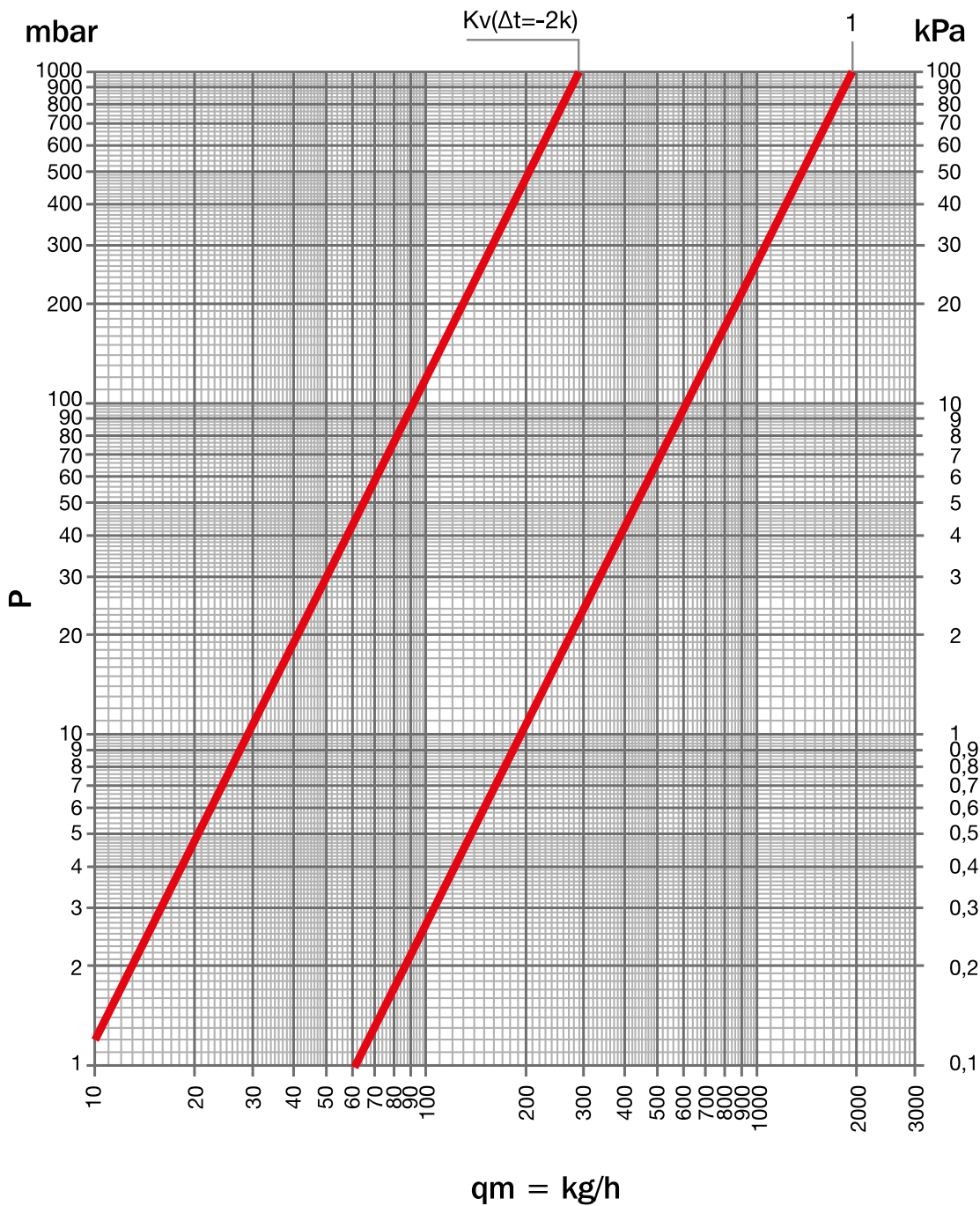

14 kW

CARATTERISTICHE TECNICHE

Pressione massima di esercizio 6 bar
Pressione massima differenziale 1 bar
Temperatura massima di esercizio 80 °C

CARATTERISTICHE TECNICHE SISTEMA CON GP 1190 + KA 1191

Pressione massima di esercizio 6 bar
Pressione massima differenziale 1 bar
Temperatura massima di esercizio sul primario 80 °C
Temperatura massima di esercizio sul secondario 70 °C
Intervallo di temperatura sul secondario 20 °C ÷ 65 °C
Potenza termica massima 14 kW con un Δt di 10 °C
e temperatura del primario ≥ 70 °C

CARATTERISTICHE COSTRUTTIVE

Le parti stampate sono in ottone a basso contenuto di piombo in conformità con le normative, CW617N UNI EN 12165:2016. Tutte le guarnizioni o-ring sono in EPDM perossidico.

Le parti in acciaio inox sono in AISI 316.

Tutti i componenti sono dotati di tenuta morbida o-ring, non necessitano di alcun elemento intermedio di sigillatura (es. PTFE, canapa, ecc). Attacchi laterali da W24x19 o da G 3/4 EK con interessi da 50 mm.

Il gruppo pompa GP 1190 ha un passaggio interno pari a un \varnothing 23 mm.

IMPIEGO

Il kit per alta temperatura KA 1191, associato ai gruppi pompa GP 1190, permette di installare in un'unica cassetta sia la distribuzione di acqua calda per un impianto tradizionale a radiatori, sia la distribuzione di acqua per un impianto a pannelli radianti.

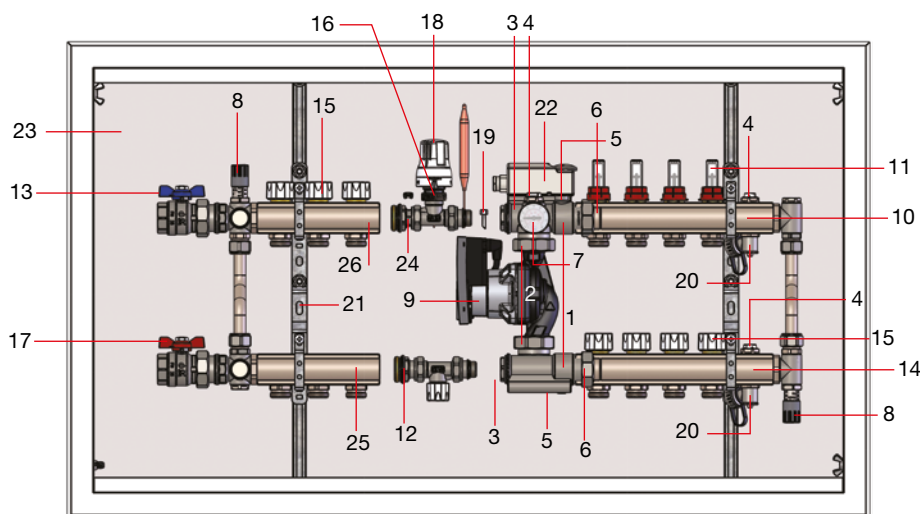

COMPONENTI

- | | |
|---|---|
| 1 Gruppo pompa | 12 Valvola di intercettazione del circuito a bassa temperatura |
| 2 Collegamenti alla pompa di circolazione con dado girevole da G 1"1/2 | 13 Valvola a sfera di ritorno alla caldaia |
| 3 Alloggiamenti per la sonda di regolazione della testa termostatica | 14 Collettore di ritorno dei pannelli radianti |
| 4 Valvola di sfogo aria manuale | 15 Valvole predisposte per la regolazione elettrotermica con cappucci di protezione |
| 5 Valvole a sfera per l'intercettazione della pompa | 16 Valvola di regolazione termostattizzabile |
| 6 Raccordi da G 1" con tenuta morbida | 17 Valvola a sfera di mandata dalla caldaia |
| 7 Termometro per la rilevazione delle temperatura impostata | 18 Testa termostatica con sensore a distanza |
| 8 Valvola di bypass differenziale | 19 Molla per il fissaggio della sonda a distanza della testa termostatica |
| 9 Pompa di circolazione con motore sincrono 25/60 interasse 130 mm in classe energetica A | 20 Rubinetto di carico e scarico acqua |
| 10 Collettore di mandata ai pannelli radianti | 21 Staffe |
| 11 Regolatori e misuratori di portata, con capacità da 0,5 l/min a 5 l/min. In caso lo sporco impedisse la lettura della portata, è possibile smontare e pulire il bicchiere con l'impianto in funzione | 22 Termostato di sicurezza bimetallico a contatto |
| | 23 Cassetta con piedi regolabili, cornice e porta bianchi RAL 9016 |
| | 24 Valvola di ritegno |
| | 25 Collettore di mandata per il primario |
| | 26 Collettore di ritorno del primario |

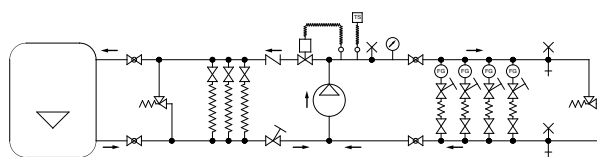
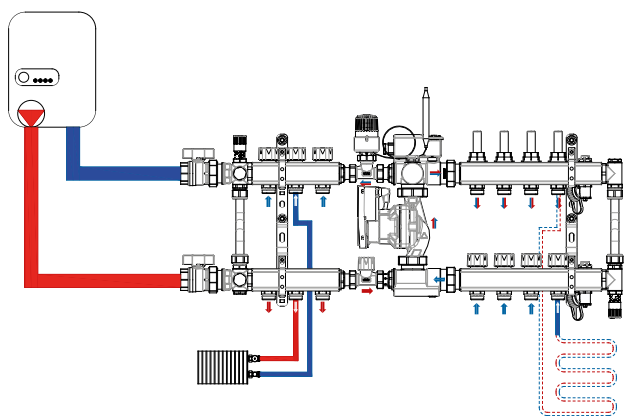

LEGENDA SCHEMI IDRAULICI

	valvola intercettazione		rubinetto di carico o scarico acqua		pompa circolazione
	valvola sfera		termometro		utilizzatore: pannelli radianti, termoarredi ecc.
	valvola non ritorno, la freccia indica il senso di flusso		dispositivo di sfogo aria manuale		filtro
	valvola di sicurezza (valvola di bypass)		dispositivo di sfogo aria automatico		valvola a 3 vie
	valvola intercettazione, regolazione e bilanciamento		misuratore di portata		
	valvola a sfera d'intercettazione, regolazione e bilanciamento		termostato di sicurezza ad immersione		
	valvola di iniezione con sensore a distanza		termostato di sicurezza a contatto		

FUNZIONAMENTO

L'acqua ad alta temperatura, proveniente dalla caldaia e dal circuito primario, entra nel gruppo pompa GP 1190, attraverso la valvola detentore d'intercettazione del kit KA 1191 che regola la massima quantità di fluido che deve entrare nel circuito secondario bilanciando quindi il primario.

La relativa acqua in uscita è controllata dalla valvola di regolazione termostattizzabile. Questa valvola viene controllata da una testa termostatica con sonda a distanza che mantiene costante ad un valore impostato la temperatura di mandata ai pannelli radianti, miscelando l'acqua ad alta temperatura della caldaia con quella in circolazione nei pannelli stessi.

Il sistema è integrato con una valvola di bypass sia sul circuito primario sia sul secondario, che in presenza di una eccessiva pressione differenziale scarichi la prevalenza in esubero salvaguardando i componenti dell'impianto e, nel caso siano utilizzate teste termoelettriche per l'intercettazione dei circuiti, eviti fenomeni di rumore e usura della pompa di circolazione. L'intervento del termostato di sicurezza deve bloccare il funzionamento della pompa.

Questo tipo di impianto riesce a fornire una potenza termica massima di 14 kW con un Δt di 10 °C e una temperatura del primario ≥ 70 °C.

SISTEMI DI REGOLAZIONE PER IMPIANTI A PANNELLI RADIANTI CON IL GRUPPO POMPA GP 1190 E KIT PER ALTA TEMPERATURA KA 1191



KA 1191

Kit per alta associato al gruppo GP 1190.

CODICE	MISURA				€
72000040	G 1"	787	1	8	87,29



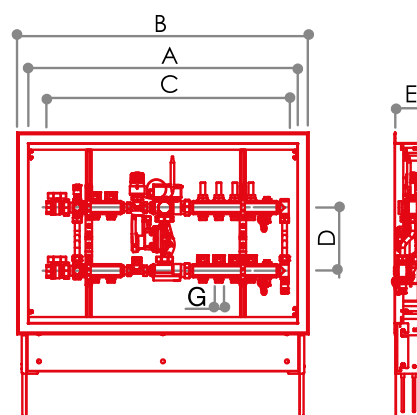

Profondità
90 mm



CCBAP 4024

Impianto con distribuzione bassa
+ 2 attacchi di alta (W24x19).

ARTICOLO	CODICE	MISURA	N. ATTACCHI PANNELLI	A	B	C	D	E	F	G		
CCBAP4024/2	17402402N	G 1" x (W24x19)	2	850	910	670	200	90		W24x19	24,648	1
CCBAP4024/3	17402403N		3	850	910	720					25,242	1
CCBAP4024/4	17402404N		4	850	910	770					25,836	1
CCBAP4024/5	17402405N		5	1000	1060	820					28,430	1
CCBAP4024/6	17402406N		6	1000	1060	870					29,024	1
CCBAP4024/7	17402407N		7	1000	1060	920					29,618	1
CCBAP4024/8	17402408N		8	1200	1260	970					32,212	1
CCBAP4024/9	17402409N		9	1200	1260	1020					32,806	1
CCBAP4024/10	17402410N		10	1200	1260	1070					33,400	1
CCBAP4024/11	17402411N		11	1200	1260	1120					33,994	1
CCBAP4024/12	17402412N		12	1300	1360	1170					36,588	1

GRUPPI PREMONTATI

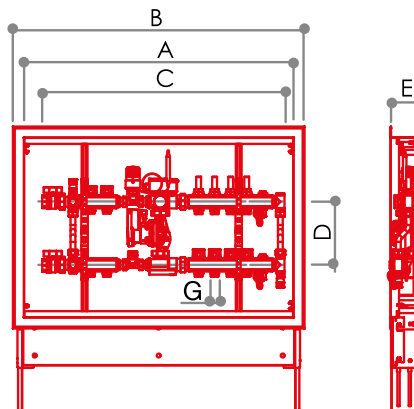

CCBAP 4023

Impianto con distribuzione bassa + 3 attacchi di alta (W24x19).

ARTICOLO	CODICE	MISURA	N. ATTACCHI PANNELLI	A	B	C	D	E	F	G		
CCBAP4023/2	17402302N	G 1" x (W24x19)	2	850	910	720	200	90	-	W24x19	25,218	1
CCBAP4023/3	17402303N		3	850	910	770			-		25,812	1
CCBAP4023/4	17402304N		4	1000	1060	820			-		28,406	1
CCBAP4023/5	17402305N		5	1000	1060	870			-		29,000	1
CCBAP4023/6	17402306N		6	1000	1060	920			-		29,594	1
CCBAP4023/7	17402307N		7	1200	1260	970			-		32,188	1
CCBAP4023/8	17402308N		8	1200	1260	1020			-		32,782	1
CCBAP4023/9	17402309N		9	1200	1260	1070			-		33,376	1
CCBAP4023/10	17402310N		10	1200	1260	1120			-		33,970	1
CCBAP4023/11	17402311N		11	1300	1360	1170			-		36,564	1
CCBAP4023/12	17402312N		12	1300	1360	1220			-		37,158	1

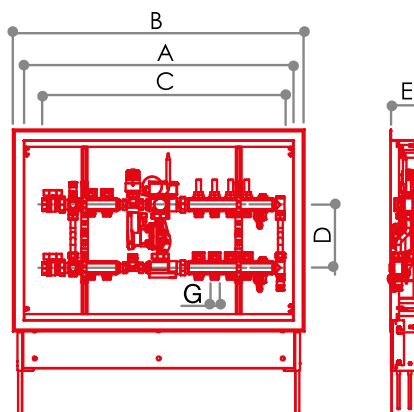
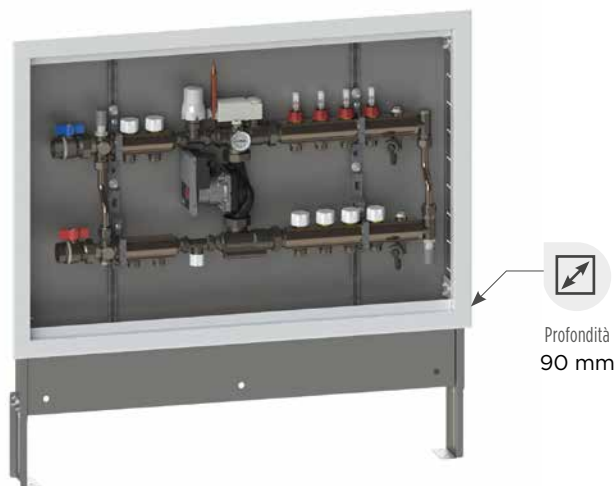

CCBAP 4034

Impianto con distribuzione bassa + 2 attacchi di alta (G 3/4 EK).

ARTICOLO	CODICE	MISURA	N. ATTACCHI PANNELLI	A	B	C	D	E	F	G		
CCBAP4034/2	17403402N	G 1" x G 3/4 EK	2	850	910	670	200	90	-	G 3/4 EK	24,648	1
CCBAP4034/3	17403403N		3	850	910	720			-		25,242	1
CCBAP4034/4	17403404N		4	850	910	770			-		25,836	1
CCBAP4034/5	17403405N		5	1000	1060	820			-		28,430	1
CCBAP4034/6	17403406N		6	1000	1060	870			-		29,024	1
CCBAP4034/7	17403407N		7	1000	1060	920			-		29,618	1
CCBAP4034/8	17403408N		8	1200	1260	970			-		32,212	1
CCBAP4034/9	17403409N		9	1200	1260	1020			-		32,806	1
CCBAP4034/10	17403410N		10	1200	1260	1070			-		33,400	1
CCBAP4034/11	17403411N		11	1200	1260	1120			-		33,994	1
CCBAP4034/12	17403412N		12	1300	1360	1170			-		36,588	1

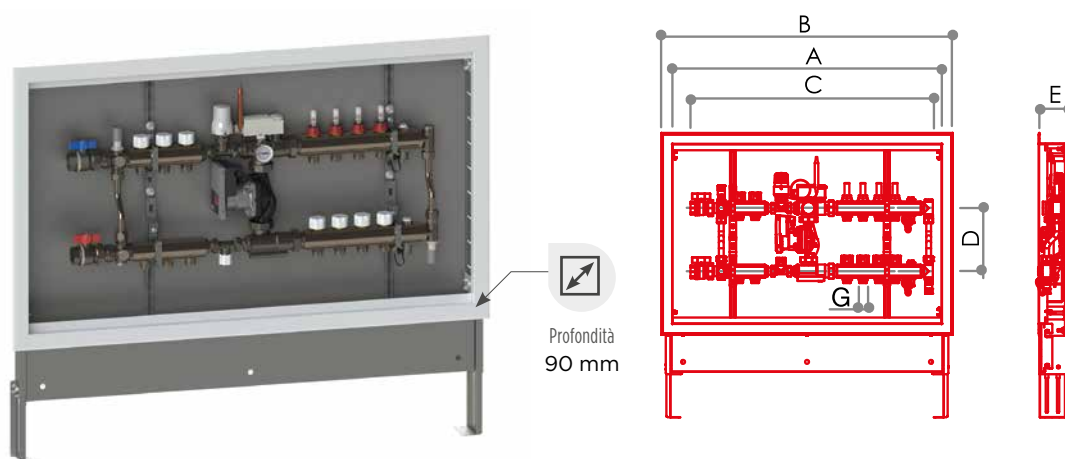
**CCBAP 4033**

Impianto con distribuzione bassa
+ 3 attacchi di alta (G 3/4 EK).



ARTICOLO	CODICE	MISURA	N. ATTACCHI PANNELLI	A	B	C	D	E	F	G		
CCBAP4033/2	17403302N	G 1" x G 3/4 EK	2	850	910	720	200	90	-		25,218	1
CCBAP4033/3	17403303N		3	850	910	770			-		25,812	1
CCBAP4033/4	17403304N		4	1000	1060	820			-		28,406	1
CCBAP4033/5	17403305N		5	1000	1060	870			-		29,000	1
CCBAP4033/6	17403306N		6	1000	1060	920			-		29,594	1
CCBAP4033/7	17403307N		7	1200	1260	970			-		32,188	1
CCBAP4033/8	17403308N		8	1200	1260	1020			-		32,782	1
CCBAP4033/9	17403309N		9	1200	1260	1070			-		33,376	1
CCBAP4033/10	17403310N		10	1200	1260	1120			-		33,970	1
CCBAP4033/11	17403311N		11	1300	1360	1170			-		36,564	1
CCBAP4033/12	17403312N		12	1300	1360	1220			-		37,158	1

DIAGRAMMA DI PORTATA



Kv	Kv Δt 2 °C	POS
0.88	0.46	1

SISTEMI DI REGOLAZIONE PER IMPIANTI A PANNELLI RADIANTI CON IL GRUPPO POMPA GP 1190 E KIT PER ALTA TEMPERATURA FM 750

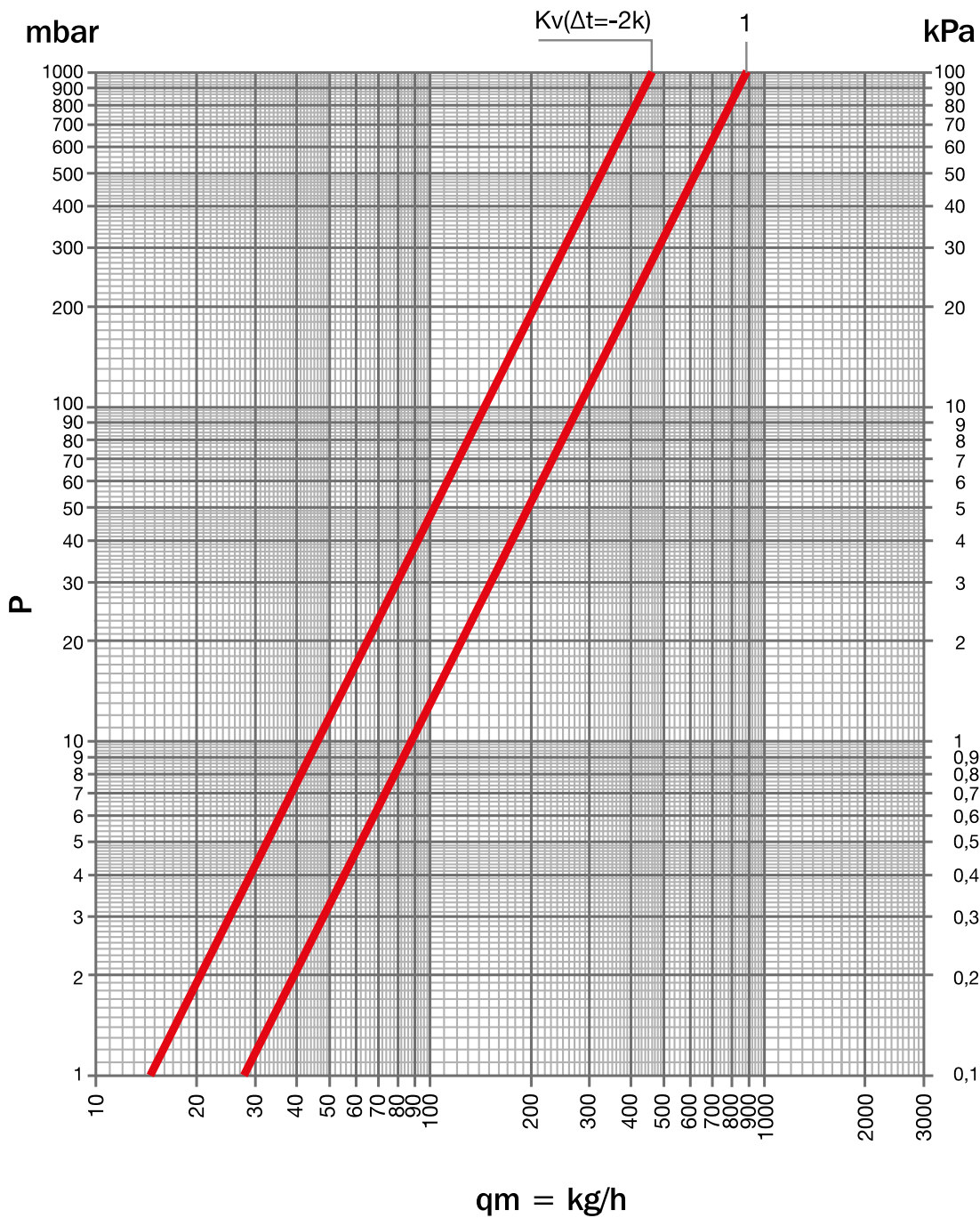

20 kW

CARATTERISTICHE TECNICHE

Pressione massima di esercizio 6 bar
 Pressione massima differenziale 1 bar
 Temperatura massima di esercizio sul primario 80 °C
 Temperatura massima di esercizio sul secondario 70 °C
 Intervallo di temperatura sul secondario 20 °C ÷ 65 °C
 Potenza termica massima 20 kW con un Δt di 10 °C
 e temperatura del primario ≥ 70 °C

CARATTERISTICHE COSTRUTTIVE

Le parti stampate sono in ottone a basso contenuto di piombo in conformità con le normative CW617N UNI EN 12165:2016. Tutte le guarnizioni o-ring sono in EPDM perossidico. Le parti in acciaio inox sono in AISI 316. Tutti i componenti sono dotati di tenuta morbida o-ring, non necessitano di alcun elemento intermedio di sigillatura (es. PTFE, canapa, ecc).

IMPIEGO

Il kit per alta temperatura FM 750 associato ai gruppi pompa GP 1190, permette di installare in un'unica cassetta sia la distribuzione di acqua calda per un impianto tradizionale a radiatori, sia la distribuzione di acqua per un impianto a pannelli radianti.

COMPONENTI

- 1 Testa termostatica con sensore a distanza
- 2 Valvola miscelatrice termostattizzabile con terza via in bypass
- 3 Raccordi da G 3/4 con tenuta morbida
- 4 Raccordi da G 1" con tenuta morbida
- 5 Raccordo femmina con guarnizione piana
- 6 Tubo rame per bypass
- 7 Raccordo a compressione
- 8 Valvola di bilanciamento

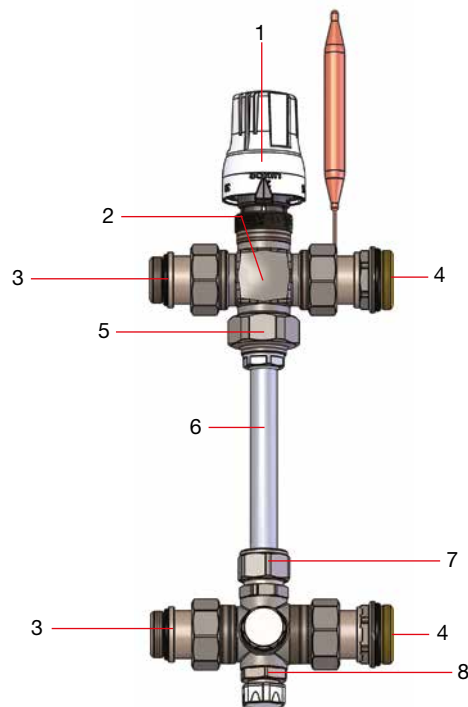

SCHEMA IDRAULICO

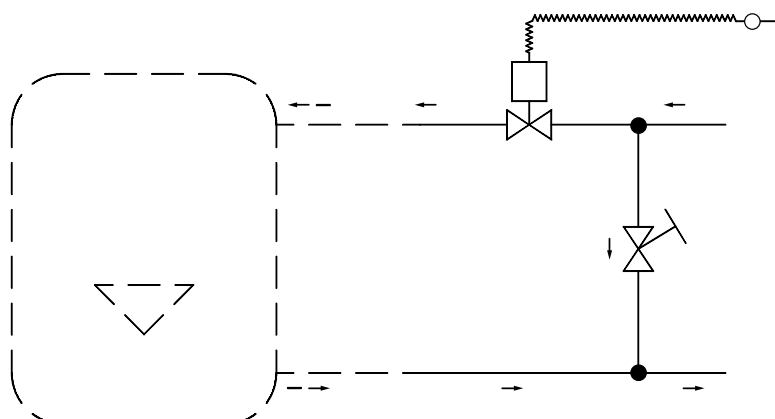

FUNZIONAMENTO

Il sistema FM 750 mantiene costante, a un valore impostato, la temperatura dell'acqua nei pannelli radianti, miscelando l'acqua ad alta temperatura in arrivo dalla caldaia con quella in ricircolo attraverso il circuito di bypass.

Una valvola termostatica con sonda a distanza rileva la temperatura e, in base al valore rilevato, integra il circuito di una quantità di acqua tale da compensare la potenza termica ceduta dai pannelli radianti.

Una valvola termostatica con sonda a distanza rileva la temperatura e, in base al valore rilevato, integra il circuito di una quantità di acqua tale da compensare la potenza termica ceduta dai pannelli radianti da mandare all'attacco a bassa temperatura del miscelatore.

Si consiglia l'utilizzo di un termostato di sicurezza da installare sulla valvola in ingresso alla pompa al fine di evitare danni dovuti a un improvviso innalzamento della temperatura.

L'intervento del termostato deve bloccare il funzionamento della pompa.

Questo tipo di impianto riesce a fornire una potenza termica massima di 20 kW con un Δt di 10 °C e una temperatura del primario ≥ 70 °C.

Il sistema "Flow Mix" può essere installato sia a sinistra sia a destra del gruppo pompa GP 1190.

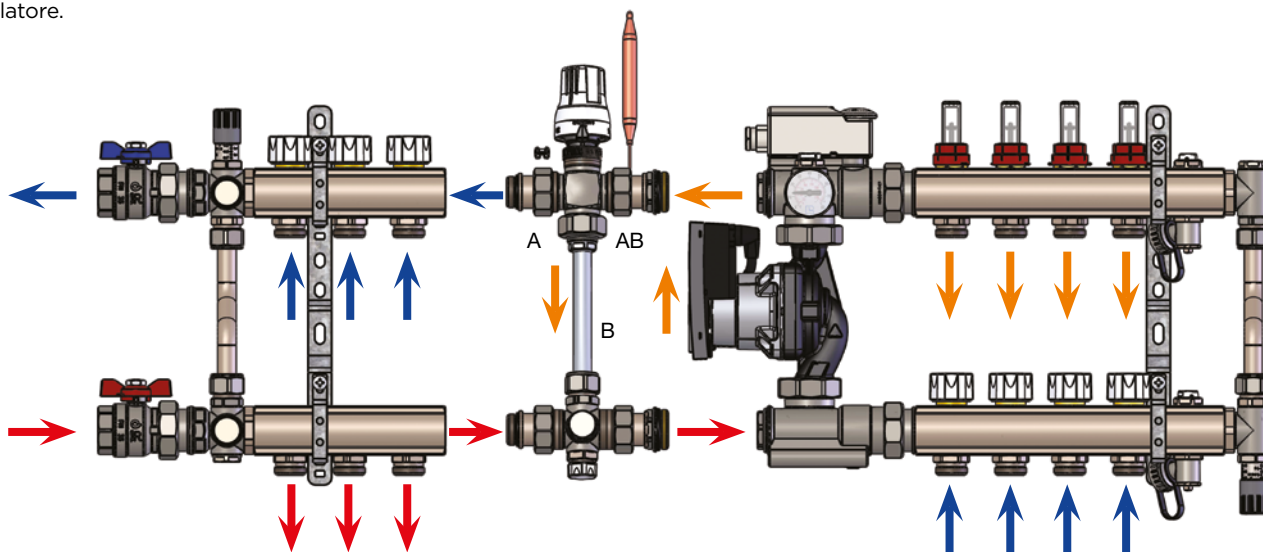

NEL PRIMO CASO

- La via della valvola miscelatrice AB deve essere collegata alla parte finale del gruppo pompa;
- La via A deve essere collegata ai collettori di ritorno della zona di alta;

- La via B è il bypass;
- La sonda della testa termostatica deve essere inserita nell'apposita sede nella parte superiore del gruppo pompa prima d'installare il **Flow Mix**.

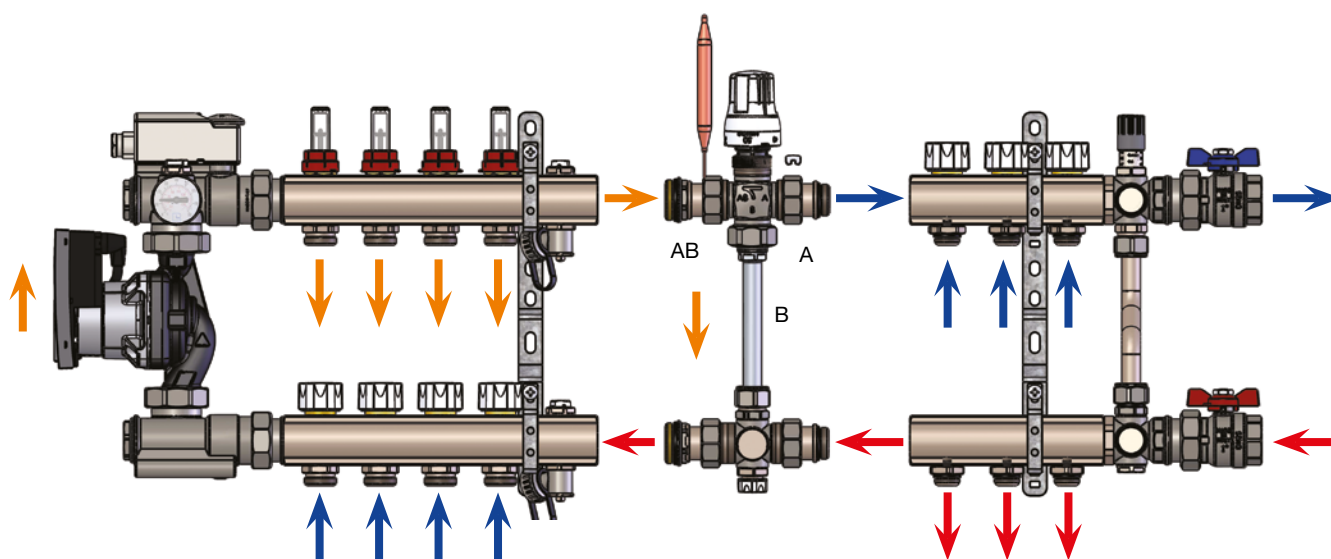

NEL SECONDO CASO

- La via della valvola miscelatrice AB deve essere collegata alla parte finale del collettore di mandata della zona di bassa;
- La via A deve essere collegata ai collettori di ritorno della zona di alta;

- La via B è il bypass;
- La sonda della testa termostatica deve essere inserita nell'apposita sede nella parte superiore del gruppo pompa.

DISEGNO DIMENSIONALE

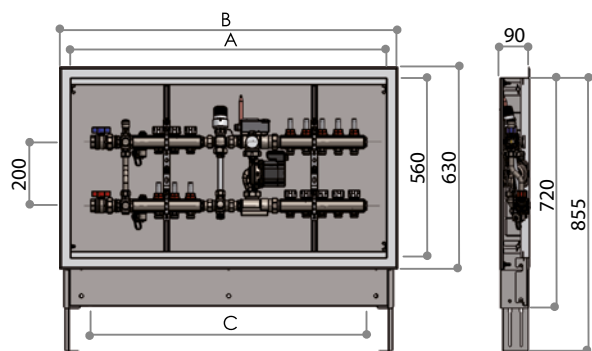

N. ATTACCHI PANNELLI	A	B	C
CON 2 STACCHI DI ALTA			
2	910	850	670
3	910	850	720
4	910	850	770
5	1060	1000	820
6	1060	1000	870
7	1060	1000	920
8	1260	1200	970
9	1260	1200	1020
10	1260	1200	1070
11	1260	1200	1120
12	1360	1300	1170
CON 3 STACCHI DI ALTA			
2	910	850	720
3	910	850	770
4	1060	1000	820
5	1060	1000	870
6	1060	1000	920
7	1260	1200	970
8	1260	1200	1020
9	1260	1200	1070
10	1260	1200	1120
11	1360	1300	1170
12	1360	1300	1220

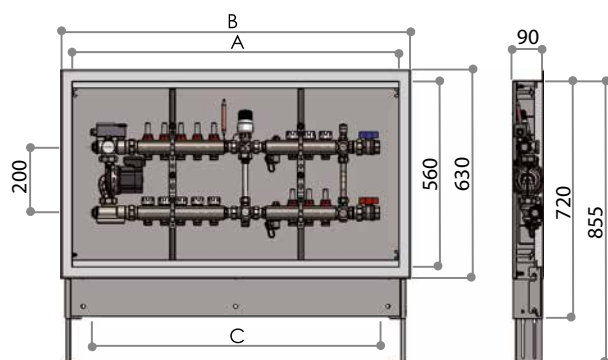

N. ATTACCHI PANNELLI	A	B	C
CON 2 STACCHI DI ALTA			
2	910	850	670
3	910	850	720
4	910	850	770
5	1060	1000	820
6	1060	1000	870
7	1060	1000	920
8	1260	1200	970
9	1260	1200	1020
10	1260	1200	1070
11	1260	1200	1120
12	1360	1300	1170
CON 3 STACCHI DI ALTA			
2	910	850	720
3	910	850	770
4	1060	1000	820
5	1060	1000	870
6	1060	1000	920
7	1260	1200	970
8	1260	1200	1020
9	1260	1200	1070
10	1260	1200	1120
11	1360	1300	1170
12	1360	1300	1220

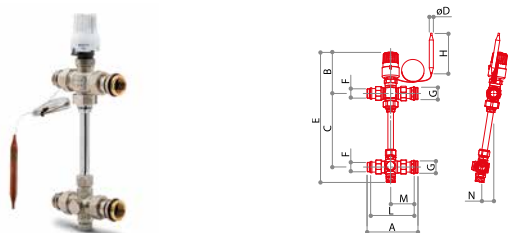
**SISTEMI DI REGOLAZIONE PER IMPIANTI A PANNELLI RADIANTI
CON IL GRUPPO POMPA GP 1190 E KIT PER ALTA TEMPERATURA**
**FM 750**

Kit flow mix con bypass per il sistema di riscaldamento misto.

CODICE	MISURA	A	B	C	D	E	F	G	H	L	M	N			
68763602	G 1"	138	115	200	11	365	G 3/4	G 1"	110	118	64	32	1442	1	8

DIAGRAMMA DI PORTATA

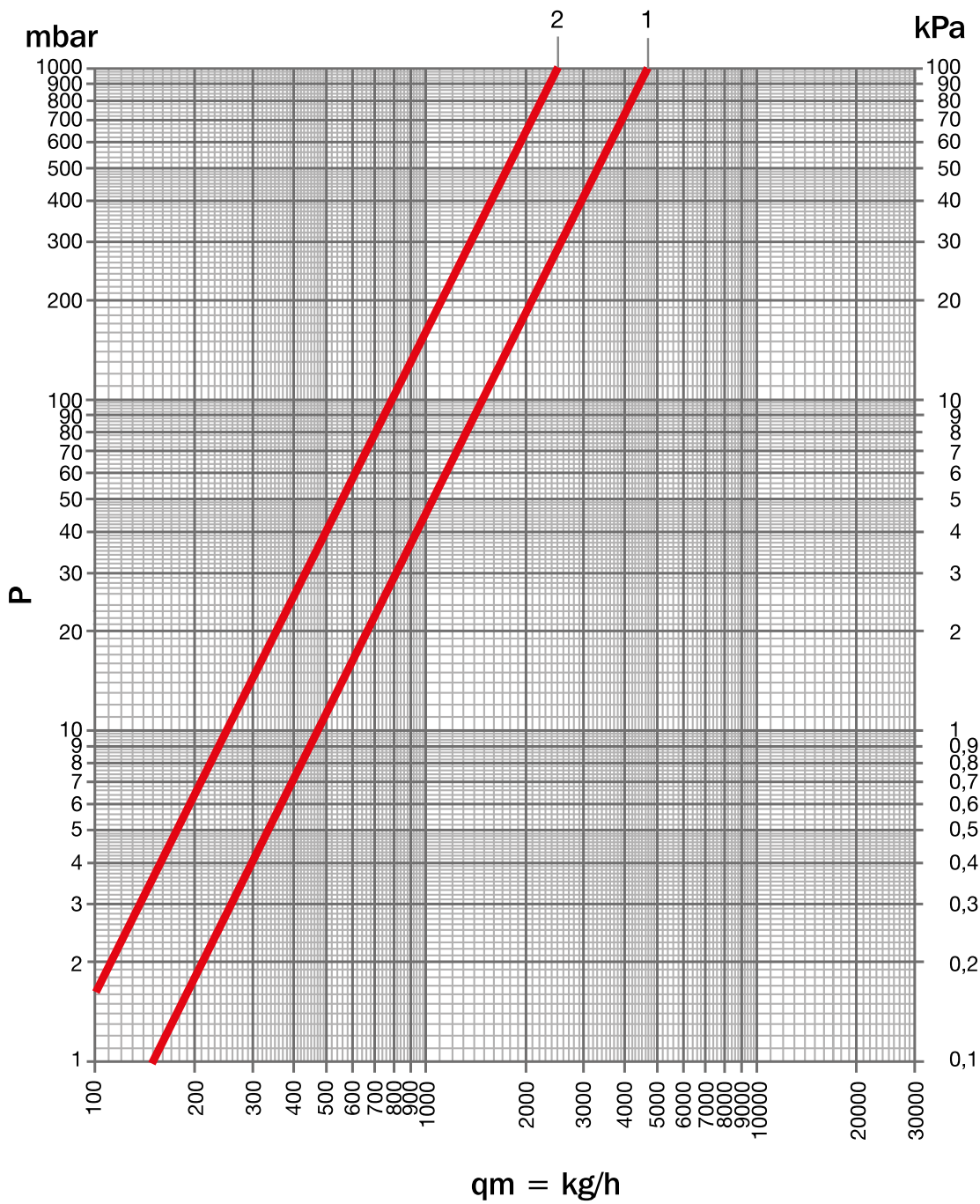

Kv	Kv Δt 2 °C		POS
4.70	0.36	via A - AB	1
2.50	-	via B - AB sempre aperta	2

SISTEMI DI REGOLAZIONE PER IMPIANTI A PANNELLI RADIANTI CON IL GRUPPO DI MISCELA GM 1192



20 kW

CARATTERISTICHE TECNICHE

Pressione massima di esercizio 6 bar
 Pressione massima differenziale 1 bar
 Campo di regolazione sul bypass 0.2 ÷ 0.7 bar
 Temperatura massima di esercizio sul primario 80 °C
 Temperatura massima di esercizio sul secondario 70 °C
 Intervallo di temperatura sul secondario 20 °C ÷ 65 °C
 Potenza termica massima 20 kW con un Δt di 10 °C
 e temperatura del primario ≥ 70 °C

CARATTERISTICHE COSTRUTTIVE

Le parti stampate sono in ottone a basso contenuto di piombo in conformità con le normative CW617N UNI EN 12165:2016. Tutte le guarnizioni o-ring sono in EPDM perossidico. Le parti in acciaio inox sono in AISI 316.

Tutti i componenti sono dotati di tenuta morbida o-ring, non necessitano di alcun elemento intermedio di sigillatura (es. PTFE, canapa, ecc).

Attacchi laterali da W24x19 o da G 3/4 EK con interassi da 50 mm. Il gruppo di miscela GM 1192 ha un passaggio interno pari a un \varnothing 23 mm.

IMPIEGO

Il gruppo di miscela GM 1192 è un gruppo di regolazione che riunisce in un unico dispositivo un insieme di componenti in grado di mantenere la temperatura in un circuito a pannelli radianti ad un valore impostato all'interno di un impianto di riscaldamento di tipo misto. La temperatura dell'acqua nei pannelli radianti viene mantenuta costante da una valvola di regolazione, la quale miscela l'acqua ad alta temperatura in arrivo dalla caldaia con quella a più bassa temperatura in circolazione nei pannelli stessi.

Il GM 1192 può essere collegato direttamente, mediante un raccordo a tenuta morbida da G 1" maschio, ai collettori per pannelli radianti di produzione Luxor già in commercio. Perciò è molto vantaggioso perché si può tenere il gruppo di miscela come componente modulare.

Inoltre un impianto di riscaldamento di tipo misto che impiega il GM 1192 diviene estremamente flessibile perché si ha la possibilità di adeguare il gruppo di miscela a successive esigenze del circuito secondario. Quindi si può espandere l'impianto a pannelli radianti aggiungendo delle uscite senza problemi di temperatura o di pressione a valle del gruppo.

Il GM 1192 può essere tarato sia per aumentare la potenza di riscaldamento che per compensare le perdite di carico.

Infine il GM 1192, in virtù della sua ampia capacità di regolazione, permette di rendere indipendente il circuito secondario da quello primario nel caso in cui vengano sostituiti componenti importanti dell'impianto, ad esempio nel caso della sostituzione di una caldaia con un'altra con differente principio di funzionamento.

Mediante l'impiego del circuito di bypass, la pompa di circolazione può continuare a funzionare alle condizioni di progetto impostate.

Questo tipo di impianto riesce a fornire una potenza termica massima 20 kW con un Δt di 10 °C e temperatura del primario ≥ 70 °C.

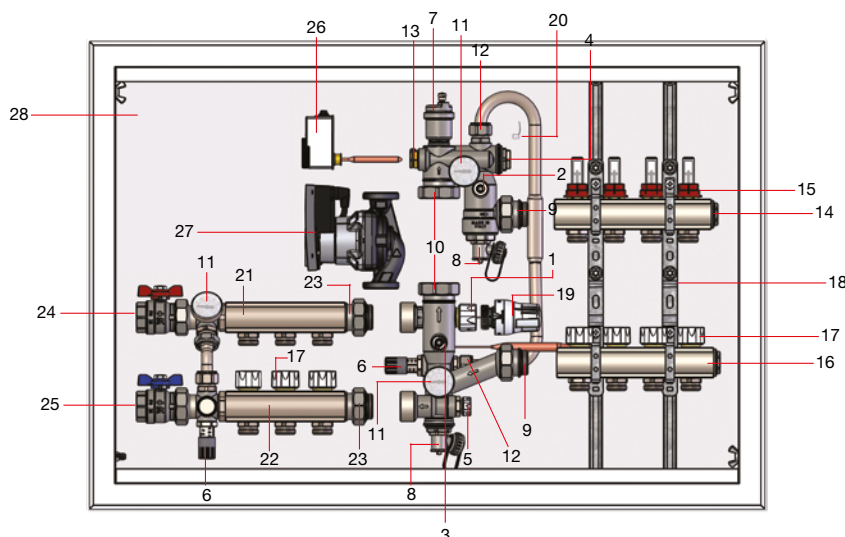





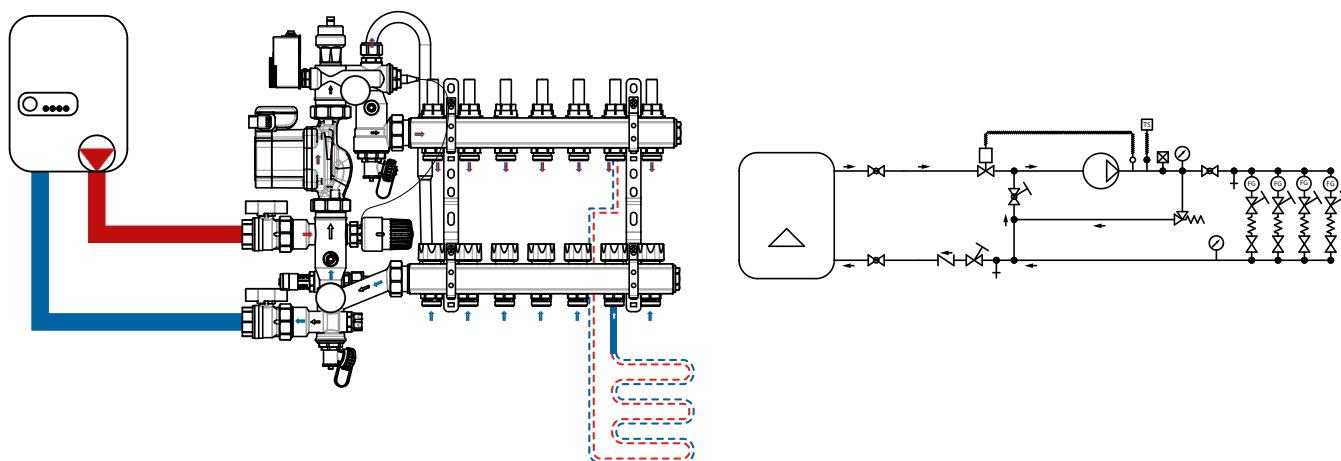



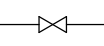

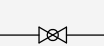

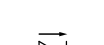

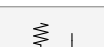
COMPONENTI

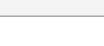
- 1 Valvola di regolazione.
La valvola di regolazione dispone di un vitone con funzionamento a pistone. Su questo vitone possono essere installati la testa termostatica per i punti fissi oppure una testa elettrotermica 0-10 Volt.
- 2 Valvola a sfera per intercettazione pompa.
Permette l'intercettazione in caso di manutenzione e sostituzione della pompa di circolazione senza vuotare l'impianto.
- 3 Valvola a sfera per intercettazione pompa e bilanciamento del circuito secondario.
È la valvola che permette di intercettare la pompa e di bilanciare le perdite di carico nel circuito secondario a pannelli radianti con le perdite di carico del circuito primario causate dalla valvola di regolazione "1". Il gruppo di regolazione GM 1192 viene fornito con la valvola di bilanciamento tarata sul valore di $K_v = 7$, poiché questo è il valore in grado di soddisfare le applicazioni fino a 11 Kw/h, qualora fossero necessarie potenze superiori, la valvola deve essere settata ad un K_v inferiore.
- 4 Pozzetto per alloggiamento della sonda.
- 5 Valvola di intercettazione del circuito a bassa temperatura.
Questa valvola viene impostata solo all'inizio della messa in esercizio per regolare la perdita di carico dell'acqua in uscita dal circuito secondario. Il detentore deve essere tutto chiuso nel caso in cui si voglia separare completamente il circuito secondario da quello primario per fare della manutenzione sul primario. Inoltre all'interno della sede è installata una valvola di non ritorno che impedisce all'acqua del primario di riscaldare il gruppo di miscela quando la pompa è spenta e la testa termostatica è chiusa. Normalmente questa valvola deve essere sempre tutta aperta.
- 6 Valvola di bypass differenziale.
L'impiego della valvola di bypass è necessario in tutti gli impianti di riscaldamento ad acqua calda dove sono presenti valvole di zona a 2 vie o corpi scaldanti muniti di valvole di regolazione che consentono in determinate condizioni, la completa esclusione del circuito. La valvola garantisce un ricircolo tale da impedire che la pompa sia utilizzata in condizioni lontane da quelle di progetto evitando sbilanciamenti dei circuiti funzionanti in parallelo e fastidiosi rumori dovuti all'aumento della velocità del fluido nell'attraversamento degli organi di regolazione.
- 7 Valvola automatica di sfogo aria (attacchi da 1/2).
Interviene durante la fase di caricamento dell'impianto sfogando l'aria presente nel gruppo.
- 8 Rubinetti di carico-scarico con attacco orientabile da 3/4 e tappo di sicurezza.
- 9 Raccordi di unione 3 pezzi a tenuta morbida CR 498 da G 1".
- 10 Raccordi da G 1 1/2 per il collegamento della pompa di circolazione.
- 11 Termometri di rilevazione della temperatura con scala da 0° a 80° C.
Permettono il controllo della temperatura dell'acqua sui collettori di mandata e ritorno dei pannelli radianti del circuito secondario.
- 12 Raccordi di unione per tubo di bypass.
- 13 Pozzetto per alloggiamento del termostato di sicurezza.
- 14 Collettore di mandata ai pannelli radianti.
- 15 Regolatori e misuratori di portata, con capacità da 0,5 l/min a 5 l/min.
In caso lo sporco impedisse la lettura della portata, è possibile smontare e pulire il bicchiere con l'impianto in funzione.
- 16 Collettore di ritorno dei pannelli radianti.
- 17 Valvole predisposte per la regolazione elettrotermica con cappucci di protezione.
- 18 Staffe.
- 19 Testa termostatica con sensore a distanza.
- 20 Molla per il fissaggio della sonda a distanza della testa termostatica.
- 21 Collettore di mandata per il primario.
- 22 Collettore di ritorno del primario.
- 23 Raccordi di unione 3 pezzi a tenuta morbida da G 1".
- 24 Valvola a sfera di mandata dalla caldaia.
- 25 Valvola a sfera di ritorno alla caldaia.
- 26 Termostato di sicurezza ad immersione.
- 27 Pompa di circolazione con motore sincrono 25/60 interasse 130 mm in classe energetica A.
- 28 Cassetta con piedi regolabili, cornice e porta bianchi RAL 9016.

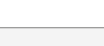

LEGENDA SCHEMI IDRAULICI

	valvola intercettazione		rubinetto di carico o scarico acqua		pompa circolazione
	valvola sfera		termometro		utilizzatore: pannelli radianti, termoarredi ecc.
	valvola non ritorno, la freccia indica il senso di flusso		dispositivo di sfogo aria manuale		filtro
	valvola di sicurezza (valvola di bypass)		dispositivo di sfogo aria automatico		valvola a 3 vie
	valvola intercettazione, regolazione e bilanciamento		misuratore di portata		
	valvola a sfera d'intercettazione, regolazione e bilanciamento		termostato di sicurezza ad immersione		
	valvola di iniezione con sensore a distanza		termostato di sicurezza a contatto		

FUNZIONAMENTO

Il sistema per il riscaldamento a punto fisso mantiene costante a un valore impostato la temperatura dell'acqua nei pannelli radianti, miscelando l'acqua ad alta temperatura in arrivo dalla caldaia con quella in circolazione nei pannelli stessi.

Una valvola termostatica con sonda a distanza rileva la temperatura e, in base al valore rilevato, integra il circuito di una quantità di acqua ad alta temperatura, tale da compensare la potenza termica ceduta dai pannelli radianti.

Si consiglia comunque di montare sulla valvola in ingresso alla pompa un termostato di sicurezza, al fine di evitare danni dovuti a un innalzamento imprevisto della temperatura.

L'intervento del termostato di sicurezza deve bloccare il funzionamento della pompa.

Il sistema può essere integrato con una valvola di bypass che, in presenza di una eccessiva pressione differenziale, scarichi la prevalenza in esubero salvaguardando i componenti dell'impianto e, nel caso siano utilizzate teste termoelettriche per l'intercettazione dei circuiti, eviti fenomeni di rumore e usura della pompa di circolazione.

Questo tipo di impianto riesce a fornire una potenza termica massima di 20 kW con un Δt di 10°C e una temperatura del primario ≥ 70 °C.

SISTEMI DI REGOLAZIONE PER IMPIANTI A PANNELLI RADIANTI CON IL GRUPPO DI MISCELA GM 1192



GM 1192

Gruppo di regolazione a punto fisso per impianti di riscaldamento a pavimento con attacco per pompa con testa termostatica.

CODICE	MISURA			
72000050	CD G 1" x 130 mm	4580	-	1
72000050X	CX G 1" X 130 mm	4744	-	1
72000055	CD G 1" x 180 mm	4610	-	1



GM 1193

Gruppo di regolazione per impianti di riscaldamento a pavimento con attacco per pompa.

CODICE	MISURA			
72000052	G 1" x 130 mm	4434	-	1
72000057	G 1" x 180 mm	4464	-	1



CB 1200

Coibentatura per gruppo di regolazione art. GM 1192 con attacco pompa da 130 mm.

CODICE	MISURA			
72000060	-	192	2	-



CB 1205

Coibentatura per collettori serie CD e CX per 12 attacchi.

CODICE	MISURA			
72000064	CD G 1"	156	-	6
72000066	CX G 1"	149	-	6
72000065	CD G 1"1/4	180	-	6

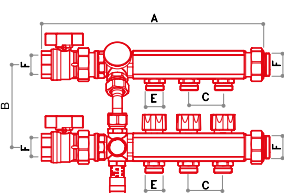

CD 4071

Kit di alta per gruppo di miscela art. GM1192.

CODICE	ARTICOLO	MISURA	A	B	C	D	E	F	G	H			
17407102N	CD4071/2	G 1" x (W24x19)	275	120	25	-	W24x19	G 1"	-	-	3490	1	-
17407103N	CD4071/3		325	120	25	-	W24x19	G 1"	-	-	4050	1	-
17407104N	CD4071/4		375	120	25	-	W24x19	G 1"	-	-	4610	1	-

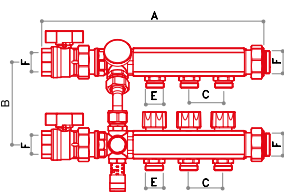

CD 4072

Kit di alta per gruppo di miscela art. GM 1192.

CODICE	ARTICOLO	MISURA	A	B	C	D	E	F	G	H			
17407202N	CD4072/2	G 1" x G 3/4 EK	275	120	25	-	G 3/4 EK	G 1"	-	-	3534	1	-
17407203N	CD4072/3		325	120	25	-	G 3/4 EK	G 1"	-	-	4116	1	-
17407204N	CD4072/4		375	120	25	-	G 3/4 EK	G 1"	-	-	4698	1	-



Profondità
90 mm

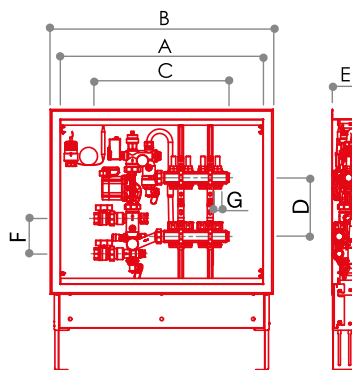

CCBP 4026

Impianto con distribuzione
a punto fisso bassa (W24x19).

ARTICOLO	CODICE	MISURA	N. ATTACCHI PANNELLI	A	B	C	D	E	F	G	H	L	kg	📦
CCBP4026/2	17402602N	G 1" x (W24x19)	2	500	560	360	200	90	120	W24x19	-	-	19,218	1
CCBP4026/3	17402603N		3	700	760	410					-	-	21,812	1
CCBP4026/4	17402604N		4	700	760	460					-	-	22,406	1
CCBP4026/5	17402605N		5	700	760	510					-	-	23,00	1
CCBP4026/6	17402606N		6	700	760	560					-	-	23,594	1
CCBP4026/7	17402607N		7	850	910	610					-	-	26,188	1
CCBP4026/8	17402608N		8	850	910	660					-	-	26,782	1
CCBP4026/9	17402609N		9	850	910	710					-	-	27,376	1
CCBP4026/10	17402610N		10	1000	1060	760					-	-	29,970	1
CCBP4026/11	17402611N		11	1000	1060	810					-	-	30,564	1
CCBP4026/12	17402612N		12	1000	1060	860					-	-	31,158	1
CCBP4026/13	17402613N		13	1200	1260	910					-	-	33,758	1



Profondità
90 mm

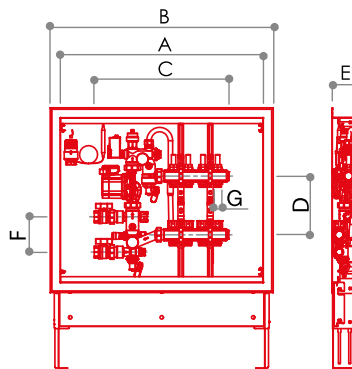

CCBP 4036

Impianto con distribuzione
a punto fisso bassa G 3/4 EK.

ARTICOLO	CODICE	MISURA	N. ATTACCHI PANNELLI	A	B	C	D	E	F	G	H	L	kg	📦
CCBP4036/2	17403602N	G 1" x G 3/4 EK	2	500	560	360	200	90	120	G 3/4 EK	-	-	19,218	1
CCBP4036/3	17403603N		3	700	760	410					-	-	21,812	1
CCBP4036/4	17403604N		4	700	760	460					-	-	22,406	1
CCBP4036/5	17403605N		5	700	760	510					-	-	23,000	1
CCBP4036/6	17403606N		6	700	760	560					-	-	23,594	1
CCBP4036/7	17403607N		7	850	910	610					-	-	26,188	1
CCBP4036/8	17403608N		8	850	910	660					-	-	26,782	1
CCBP4036/9	17403609N		9	850	910	710					-	-	27,376	1
CCBP4036/10	17403610N		10	1000	1060	760					-	-	29,970	1
CCBP4036/11	17403611N		11	1000	1060	810					-	-	30,564	1
CCBP4036/12	17403612N		12	1000	1060	860					-	-	31,158	1
CCBP4036/13	17403613N		13	1200	1260	910					-	-	33,758	1

GRUPPI PREMONTATI

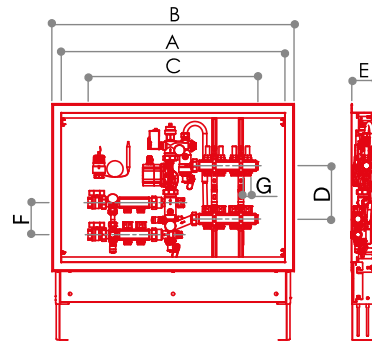
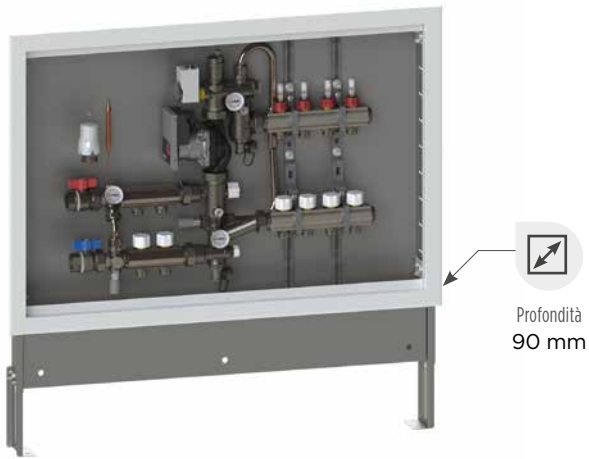

CCBAP 4025

Impianto con distribuzione bassa
+ 2 attacchi di alta (W24x19).

ARTICOLO	CODICE	MISURA	N. ATTACCHI PANNELLI	A	B	C	D	E	F	G	H	L		
CCBAP4025/2	17402502N	G 1" x (W24x19)	2	700	760	540	200	90	120	W24x19	-	-	23,648	1
CCBAP4025/3	17402503N		3	700	760	590					-	-	24,242	1
CCBAP4025/4	17402504N		4	850	910	640					-	-	26,836	1
CCBAP4025/5	17402505N		5	850	910	690					-	-	27,430	1
CCBAP4025/6	17402506N		6	850	910	740					-	-	28,024	1
CCBAP4025/7	17402507N		7	1000	1060	790					-	-	30,618	1
CCBAP4025/8	17402508N		8	1000	1060	840					-	-	31,212	1
CCBAP4025/9	17402509N		9	1000	1060	890					-	-	31,806	1
CCBAP4025/10	17402510N		10	1200	1260	940					-	-	34,400	1
CCBAP4025/11	17402511N		11	1200	1260	990					-	-	34,994	1
CCBAP4025/12	17402512N		12	1200	1260	1040					-	-	35,588	1
CCBAP4025/13	17402513N		13	1200	1260	1090					-	-	36,182	1

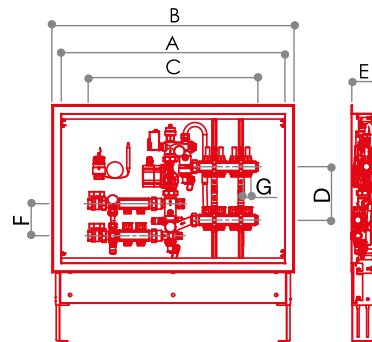
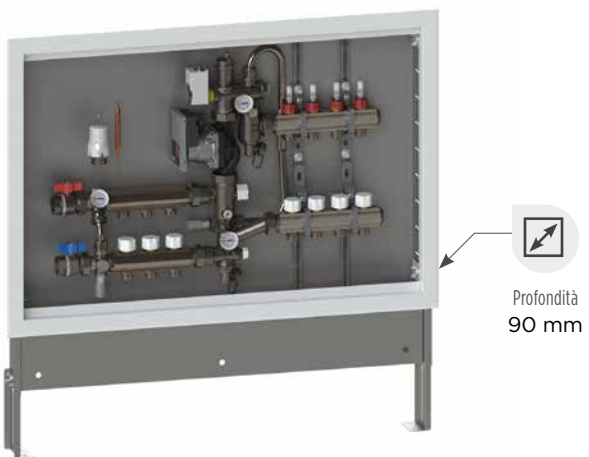

CCBAP 4027

Impianto con distribuzione bassa
+ 3 attacchi di alta (W24x19).

ARTICOLO	CODICE	MISURA	N. ATTACCHI PANNELLI	A	B	C	D	E	F	G	H	L		
CCBAP4027/2	17402702N	G 1" x (W24x19)	2	700	760	590	200	90	120	W24x19	-	-	24,218	1
CCBAP4027/3	17402703N		3	850	910	640					-	-	26,812	1
CCBAP4027/4	17402704N		4	850	910	690					-	-	27,406	1
CCBAP4027/5	17402705N		5	850	910	740					-	-	28,000	1
CCBAP4027/6	17402706N		6	1000	1060	790					-	-	30,594	1
CCBAP4027/7	17402707N		7	1000	1060	840					-	-	31,188	1
CCBAP4027/8	17402708N		8	1000	1060	890					-	-	31,782	1
CCBAP4027/9	17402709N		9	1200	1260	940					-	-	34,376	1
CCBAP4027/10	17402710N		10	1200	1260	990					-	-	34,970	1
CCBAP4027/11	17402711N		11	1200	1260	1040					-	-	35,564	1
CCBAP4027/12	17402712N		12	1200	1260	1090					-	-	36,158	1
CCBAP4027/13	17402713N		13	1300	1360	1140					-	-	38,752	1

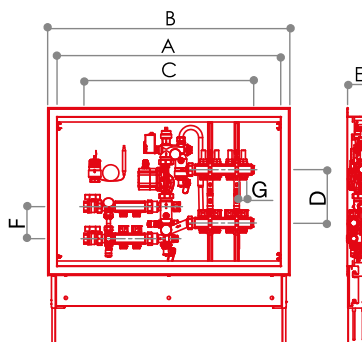

CCBAP 4079

Impianto con distribuzione bassa
+ 4 attacchi di alta (W24x19).

ARTICOLO	CODICE	MISURA	N. ATTACCHI PANNELLI	A	B	C	D	E	F	G	H	L	kg	📦
CCBAP4079/2	17407902N	G 1" x (W24x19)	2	850	910	640	200	90	120	W24x19	-	-	24,788	1
CCBAP4079/3	17407903N		3	850	910	690					-	-	27,382	1
CCBAP4079/4	17407904N		4	850	910	740					-	-	27,976	1
CCBAP4079/5	17407905N		5	1000	1060	790					-	-	28,570	1
CCBAP4079/6	17407906N		6	1000	1060	840					-	-	31,164	1
CCBAP4079/7	17407907N		7	1000	1060	890					-	-	31,758	1
CCBAP4079/8	17407908N		8	1200	1260	940					-	-	32,352	1
CCBAP4079/9	17407909N		9	1200	1260	990					-	-	34,946	1
CCBAP4079/10	17407910N		10	1200	1260	1040					-	-	35,540	1
CCBAP4079/11	17407911N		11	1200	1260	1090					-	-	36,134	1
CCBAP4079/12	17407912N		12	1300	1360	1140					-	-	36,728	1
CCBAP4079/13	17407913N		13	1300	1360	1190					-	-	39,322	1

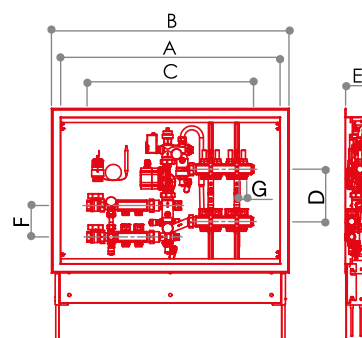
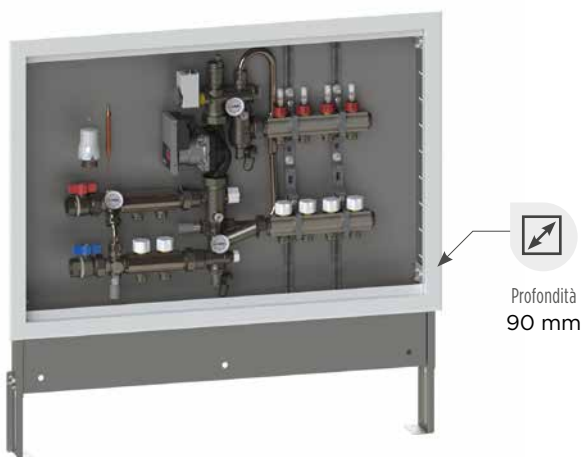

CCBAP 4035

Impianto con distribuzione bassa
+ 2 attacchi di alta G 3/4 EK.

ARTICOLO	CODICE	MISURA	N. ATTACCHI PANNELLI	A	B	C	D	E	F	G	H	L	kg	📦
CCBAP4035/2	17403502N	G 1" x G 3/4 EK	2	700	760	540	200	90	120	G 3/4 EK	-	-	23,648	1
CCBAP4035/3	17403503N		3	700	760	590					-	-	24,242	1
CCBAP4035/4	17403504N		4	850	910	640					-	-	26,836	1
CCBAP4035/5	17403505N		5	850	910	690					-	-	27,430	1
CCBAP4035/6	17403506N		6	850	910	740					-	-	28,024	1
CCBAP4035/7	17403507N		7	1000	1060	790					-	-	30,618	1
CCBAP4035/8	17403508N		8	1000	1060	840					-	-	31,212	1
CCBAP4035/9	17403509N		9	1000	1060	890					-	-	31,806	1
CCBAP4035/10	17403510N		10	1200	1260	940					-	-	34,400	1
CCBAP4035/11	17403511N		11	1200	1260	990					-	-	34,994	1
CCBAP4035/12	17403512N		12	1200	1260	1040					-	-	35,588	1
CCBAP4035/13	17403513N		13	1200	1260	1090					-	-	36,182	1

GRUPPI PREMONTATI



Profondità
90 mm

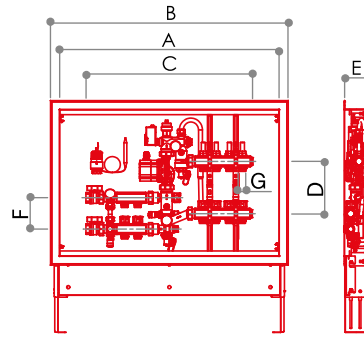

CCBAP 4037

Impianto con distribuzione bassa
+ 3 attacchi di alta G 3/4 EK.

ARTICOLO	CODICE	MISURA	N. ATTACCHI PANNELLI	A	B	C	D	E	F	G	H	L		
CCBAP4037/2	17403702N	G 1" x G 3/4 EK	2	700	760	590	200	90	120	G 3/4 EK	-	-	24,218	1
CCBAP4037/3	17403703N		3	850	910	640					-	-	26,812	1
CCBAP4037/4	17403704N		4	850	910	690					-	-	27,406	1
CCBAP4037/5	17403705N		5	850	910	740					-	-	28,000	1
CCBAP4037/6	17403706N		6	1000	1060	790					-	-	30,594	1
CCBAP4037/7	17403707N		7	1000	1060	840					-	-	31,188	1
CCBAP4037/8	17403708N		8	1000	1060	890					-	-	31,782	1
CCBAP4037/9	17403709N		9	1200	1260	940					-	-	34,376	1
CCBAP4037/10	17403710N		10	1200	1260	990					-	-	34,970	1
CCBAP4037/11	17403711N		11	1200	1260	1040					-	-	35,564	1
CCBAP4037/12	17403712N		12	1200	1260	1090					-	-	36,158	1
CCBAP4037/13	17403713N		13	1300	1360	1140					-	-	38,752	1



Profondità
90 mm

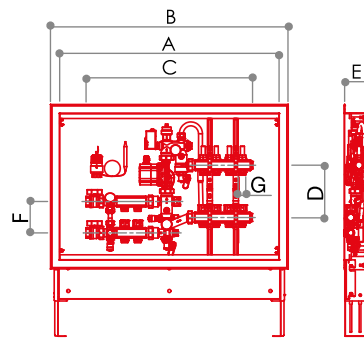

CCBAP 4080

Impianto con distribuzione bassa
+ 4 attacchi di alta G 3/4 EK.

ARTICOLO	CODICE	MISURA	N. ATTACCHI PANNELLI	A	B	C	D	E	F	G	H	L		
CCBAP4080/2	17408002N	G 1" x G 3/4 EK	2	850	910	640	200	90	120	G 3/4 EK	-	-	24,788	1
CCBAP4080/3	17408003N		3	850	910	690					-	-	27,382	1
CCBAP4080/4	17408004N		4	850	910	740					-	-	27,976	1
CCBAP4080/5	17408005N		5	1000	1060	790					-	-	28,570	1
CCBAP4080/6	17408006N		6	1000	1060	840					-	-	31,164	1
CCBAP4080/7	17408007N		7	1000	1060	890					-	-	31,758	1
CCBAP4080/8	17408008N		8	1200	1260	940					-	-	32,352	1
CCBAP4080/9	17408009N		9	1200	1260	990					-	-	34,946	1
CCBAP4080/10	17408010N		10	1200	1260	1040					-	-	35,540	1
CCBAP4080/11	17408011N		11	1200	1260	1090					-	-	36,134	1
CCBAP4080/12	17408012N		12	1300	1360	1140					-	-	36,728	1
CCBAP4080/13	17408013N		13	1300	1360	1190					-	-	39,322	1

GRUPPI POMPA PER SOLARE



CARATTERISTICHE COSTRUTTIVE

Le parti stampate sono in ottone a basso contenuto di piombo in conformità con le normative CW617N UNI EN 12165:2016. Tutte le guarnizioni o-ring sono in EPDM perossidico. Le guarnizioni sono in PTFE G415 caricato a carbografite.

I gusci di isolamento per la coibentatura sono in PPE nero (40 kg/m³).

Tutti i componenti sono dotati di tenuta morbida o-ring, non necessitano di alcun elemento intermedio di sigillatura (es. canapa, ecc.).

CARATTERISTICHE TECNICHE

Temperatura massima di esercizio in continuo 130 °C
 Range limitatore di flusso 0,5 ÷ 15 l/min
 Range termometri 0 ÷ 160 °C
 Pressione taratura valvola di sicurezza 6 bar
 Range manometro 0 ÷ 16 bar
 Fluido di lavoro acqua con glicole (max 50%).

CARATTERISTICHE TECNICHE CIRCOLATORE

Modello Grundfos Solar 15-65 130
 Conessioni da 1" M a tenuta piana
 Interasse 130 mm
 Classe di temperatura TF 110
 Temperatura massima di picco 140 °C
 Pressione massima di esercizio 10 bar

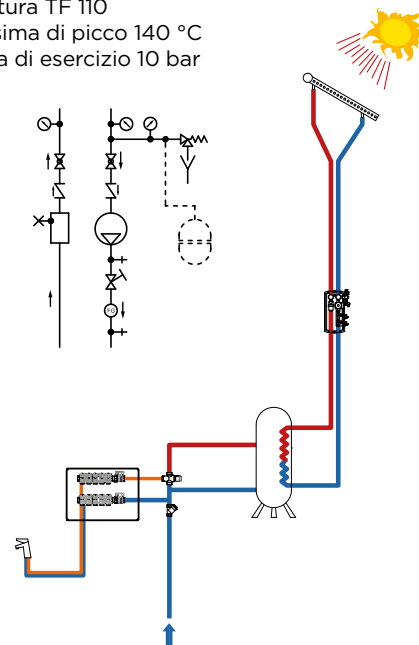

LEGENDA SCHEMI IDRAULICI

	valvola intercettazione		rubinetto di carico o scarico acqua		pompa circolazione
	valvola sfera		termometro		utilizzatore: pannelli radianti, termoarredi ecc.
	valvola non ritorno, la freccia indica il senso di flusso		dispositivo di sfogo aria manuale		filtro
	valvola di sicurezza (valvola di bypass)		dispositivo di sfogo aria automatico		valvola a 3 vie
	valvola intercettazione, regolazione e bilanciamento		misuratore di portata		
	valvola a sfera d'intercettazione, regolazione e bilanciamento		termostato di sicurezza ad immersione		
	valvola di iniezione con sensore a distanza		termostato di sicurezza a contatto		

FUNZIONAMENTO

I sistemi gruppo pompa solare hanno lo scopo di utilizzare l'energia termica solare e trasferirla a un fluido termovettore, che a sua volta la cede all'acqua necessaria all'utenza.

I gruppi sono dotati di una pompa che fa circolare il fluido termovettore all'interno dell'impianto, e tutti i componenti di cui è costituito sono costruiti con materiali e caratteristiche

adatte a sopportare le elevate temperature che il fluido può raggiungere.

Inoltre i gruppi sono completi di valvole per l'intercettazione della pompa, rubinetti di carico e scarico, valvola di ritegno, valvola di sicurezza, flussimetro e coibentatura. Il disareatore/deareatore è presente solo sul modello GSP 1180.

GRUPPI POMPA PER SOLARE

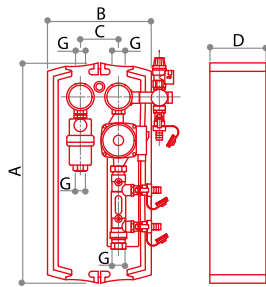

GSP 1180

Gruppo pompa solare completo di valvole di intercettazione con termometri integrati, disaeratore/deareatore, rubinetti di carico/scarico, valvole di ritegno, valvola di sicurezza 6 bar, coibentatura e flussimetro range 0,5 - 15 l/min.
Temperatura massima d'esercizio 130 °C.

CODICE	MISURA	A	B	C	D	E	F	G	H	L			
72000010	G 3/4	440	250	125	115	-	-	G 3/4	-	-	5028	1	-

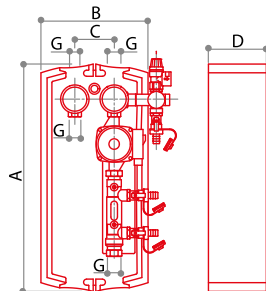

GSP 1182

Gruppo pompa solare completo di valvole di intercettazione con termometri integrati, rubinetti di carico/scarico, valvole di ritegno, valvola di sicurezza 6 bar, coibentatura e flussimetro range 0,5 - 15 l/min.
Temperatura massima d'esercizio 130 °C.

CODICE	MISURA	A	B	C	D	E	F	G	H	L			
72000012	G 3/4	440	250	125	115	-	-	G 3/4	-	-	4478	1	-



CE 1370

Centralina elettronica differenziale a microprocessore per impianti solari.

CODICE	MISURA			
69011470	-	530	1	-



AC 1180

Accessori per il collegamento dei gruppi pompa solare al vaso d'espansione con valvola di ritegno bidirezionale e staffa di fissaggio a muro.

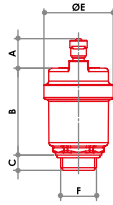

CODICE	MISURA			
68559880	G 3/4	1116	1	-

**VS 604/S**

Valvola sfogo aria automatica.
200°C - 10 bar.



Collaudo
100%

CODICE	MISURA	A	B	C	D	E	F	G	H	L			
67791017	G 3/8	17	50	9	-	40	G 3/8	-	-	-	138	10	100
67791021	G 1/2	17	50	9	-	40	G 1/2	-	-	-	138	10	100

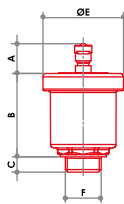
**VS 601/S**

Valvola di sfogo aria automatica tipo
medio. 200°C - 10 bar.



Collaudo
100%

CODICE	MISURA	A	B	C	D	E	F	G	H	L			
67790817	G 3/8	17	50	9	-	46	G 3/8	-	-	-	154	10	100
67790821	G 1/2	17	50	9	-	46	G 1/2	-	-	-	154	10	100
67790827	G 3/4	17	50	9	-	46	G 3/4	-	-	-	154	10	100

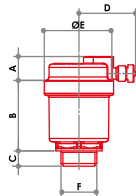
**VS 603/S**

Valvola sfogo aria automatica
con sfiato laterale. 200°C - 10 bar.



Collaudo
100%

CODICE	MISURA	A	B	C	D	E	F	G	H	L			
67790917	G 3/8	14	41	9	34	40	G 3/8	-	-	-	160	10	100
67790921	G 1/2	14	41	9	34	40	G 1/2	-	-	-	160	10	100

DIAGRAMMA DI PORTATA

VALVOLA DI REGOLAZIONE CON TESTA TERMOSTATICA

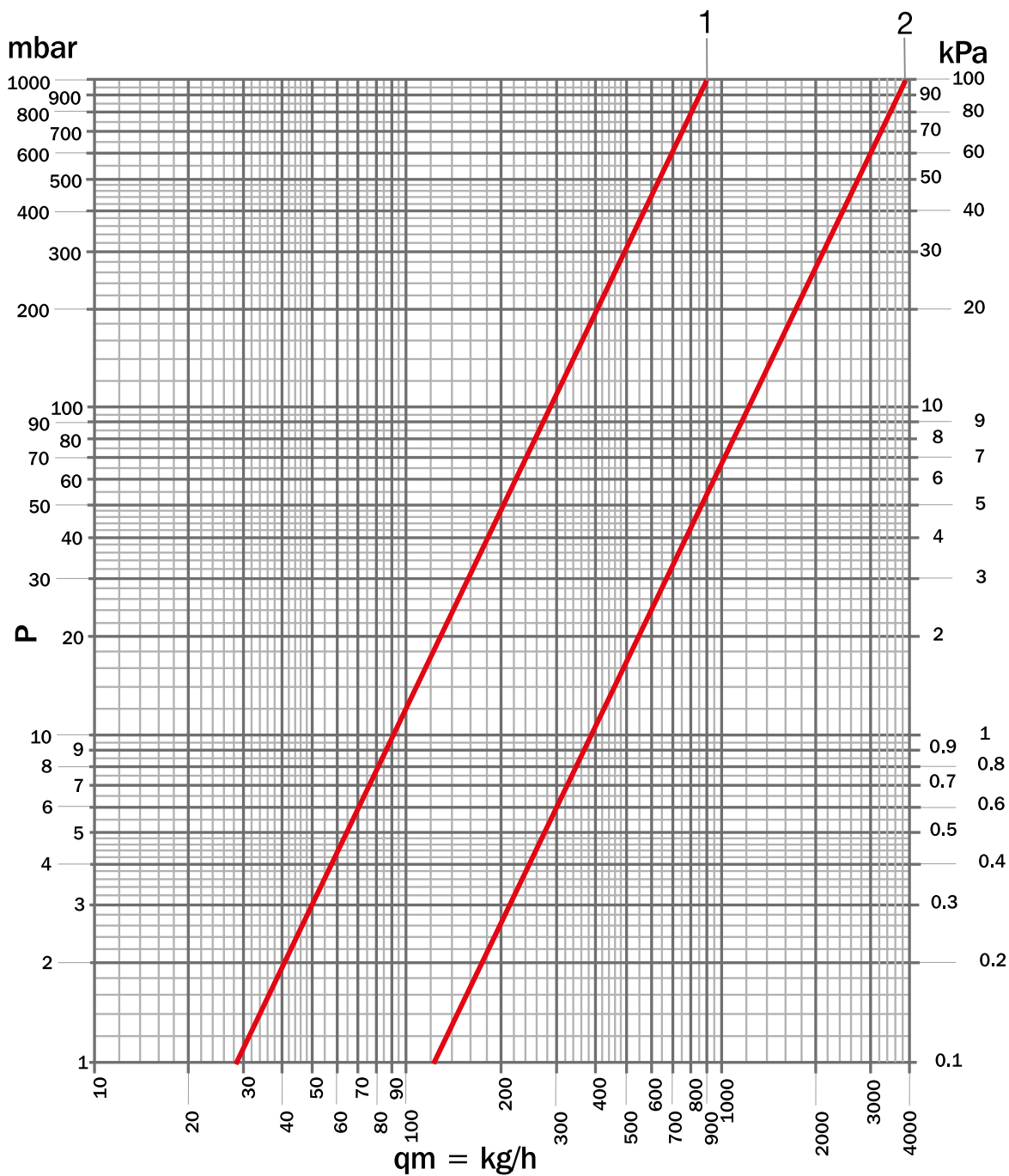

Kvs	REGOLAZIONE	POS
0,9	$\Delta T=2\text{ K}$	1
3,88	QM MAX	2

DIAGRAMMA DI PORTATA

VALVOLA DI INTERCETTAZIONE

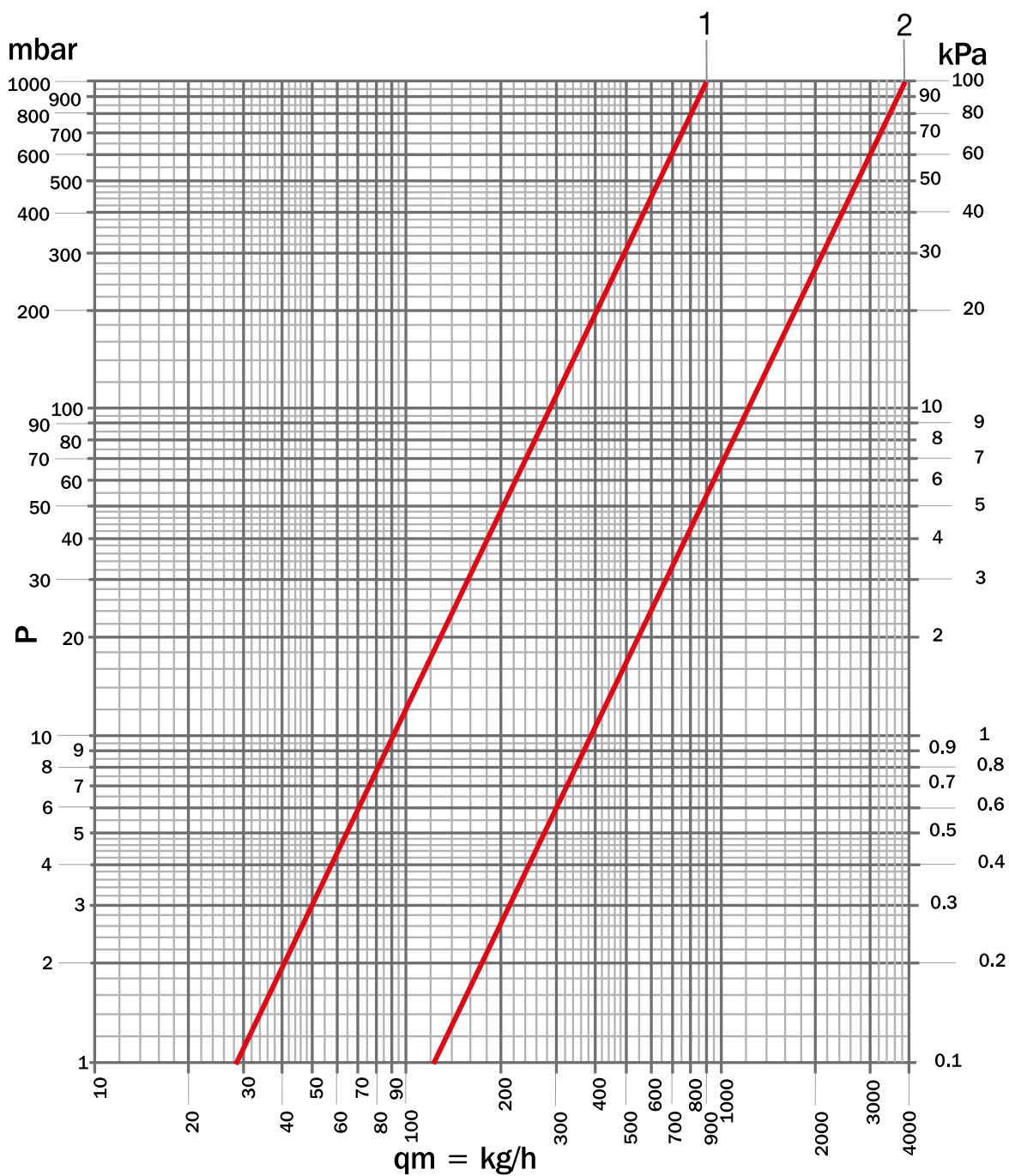

Kvs	REGOLAZIONE	POS
0,09	01/2	1
0,27	1	2
0,76	1+1/2	3
0,98	2	4
1,20	2+1/2	5
1,46	3	6
1,70	3+1/2	7
1,93	4	8
2,19	4+1/2	9
2,47	5	10
2,75	5+1/2	11
3,01	tutto aperto	12



5 / ACCESSORI ELETTRICI ED ELETTRONICI

TESTE TERMOELETTRICHE



CARATTERISTICHE TECNICHE

Le teste termoelettriche per il loro funzionamento sfruttano la dilatazione di un elemento termosensibile che, al momento in cui la valvola deve essere aperta, è scaldato tramite una resistenza elettrica. Questo funzionamento permette di avere un ciclo di apertura e chiusura lento, impedendo quindi all'impianto di subire "colpi d'ariete". Le teste termoelettriche devono essere collegate esclusivamente a termostati o cronotermostati del tipo on-off. Non si possono utilizzare termostati o cronotermostati a 3 punti o modulanti.

Le teste termoelettriche serie TE sono tutte del tipo normalmente chiuso. Le teste quindi si aprono solo quando dal sensore di comando (es. termostato) arriva il comando di apertura (tensione). Questo permette alla testa di lavorare solo quando c'è la necessità di passaggio di acqua calda o fredda attraverso il corpo scaldante e rimanere inattiva per tutto il restante periodo. Le nuove teste termoelettriche possono essere installate in qualunque posizione, anche capovolte, in quanto sono protette contro le eventuali perdite dei vitoni termostatici.

	TE 3010	TE 3011	TE 3012	TE 3013
tensione di alimentazione	230 V AC, +10%...-10%, 50/60 Hz	24 V AC/DC, +20%...-10%	230 V AC, +10%...-10%, 50/60 Hz	24 V AC/DC, +20%...-10%
max corrente in entrata	<550 mA per max 100 ms	<300 mA per max 2 min	<550 mA per max 100 ms	<300 mA per max 2 min
potenza di esercizio	1 W	1 W	1 W	1 W
corsa di regolazione	3.5 mm	3.5 mm	3.5 mm	3.5 mm
forza di regolazione	90 N +10%	90 N +10%	90 N +10%	90 N +10%
tensione/corrente di commutazione microinteruttore	-	-	230 V AC: carico resistivo 5 A, carico induttivo 1 A	24 V AC: carico resistivo 3 A, carico induttivo 1 A
punto di scatto NC	-	-	Ca. 2 mm	Ca. 2 mm
temperatura fluido	0÷100 °C	0÷100 °C	0÷100 °C	0÷100 °C
temperatura di stoccaggio	-25÷60 °C	-25÷60 °C	-25÷60 °C	-25÷60 °C
temperatura ambiente	0÷60 °C	0÷60 °C	0÷60 °C	0÷60 °C
grado di protezione	IP 54	IP 54	IP 54	IP 54
classe di protezione	II	III	II	III
conformità CE	EN 60730	EN 60730	EN 60730	EN 60730
materiale alloggiamento	Poliammide			
colore alloggiamento	Grigio chiaro RAL 7035			
cavi di alimentazione	2x0.75 mm ² PVC	2x0.75 mm ² PVC	4x0.75 mm ² PVC	4x0.75 mm ² PVC
colore cavo	Grigio chiaro RAL 7035			
lunghezza cavi	1 m	1 m	1 m	1 m
peso	100 g	100 g	Ca. 150 g	Ca. 150 g
resistenza alle sovratensioni conforme a EN 60730-1	2.5 kV	1 kV	2.5 kV	1 kV

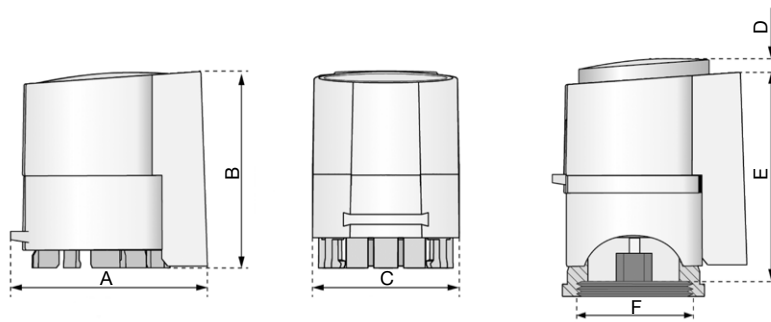

CODICE	MISURA	A	B	C	D	E	F	G	H	L
69011051	M30x1,5	49	47,5	36	7	51	M30x1,5	-	-	-
69011052		49	47,5	36	7	51		-	-	-
69011056		59	50	36	7	53,5		-	-	-
69011057		59	50	36	7	53,5		-	-	-

CURVE CARATTERISTICHE

TE 3010 - TE 3011

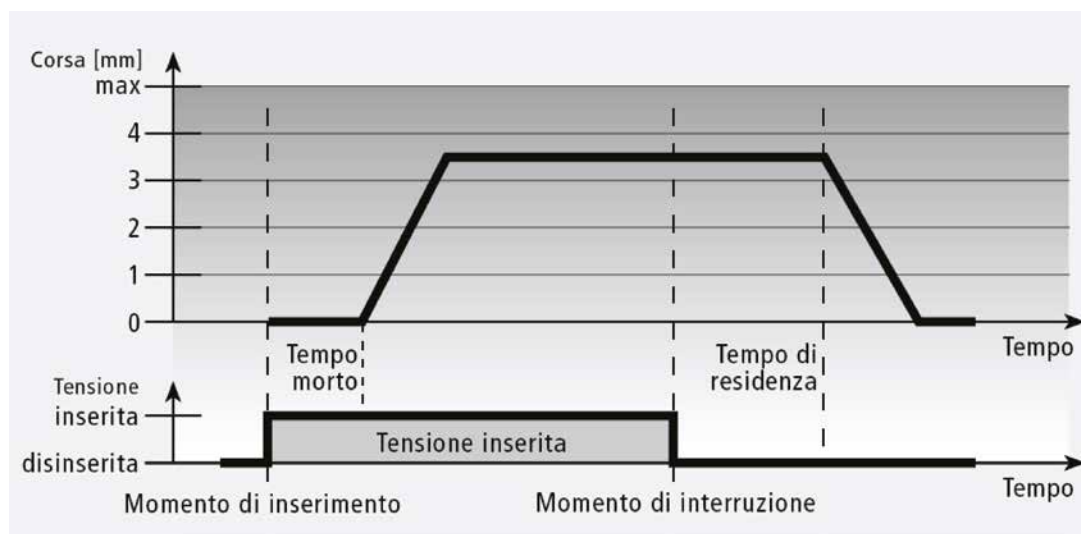

TE 3012 - TE 3013

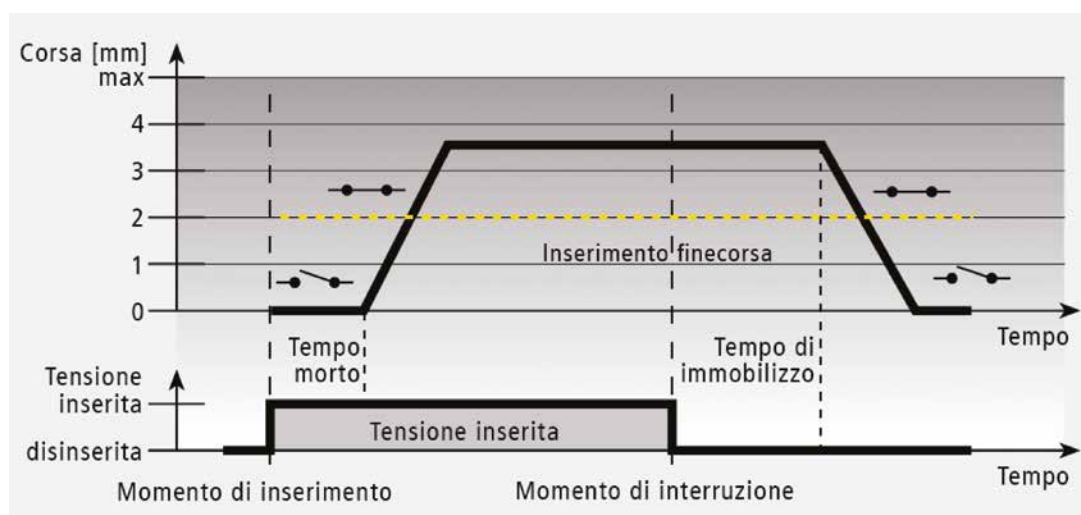

ISTRUZIONI DI MONTAGGIO: ASSEMBLAGGIO CON ADATTATORE PER VALVOLA

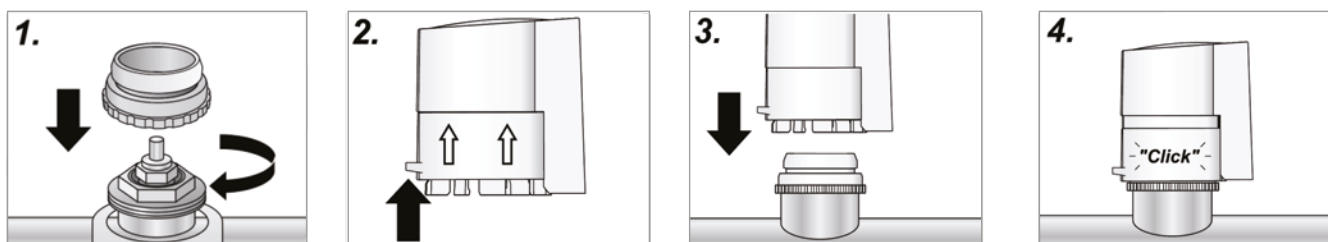

ISTRUZIONI PER IL MONTAGGIO DELLE TESTE TERMOELETTRICHE

- Avvitare completamente l'adattatore in plastica sul filetto del vitone termostatzabile (fig. 1);
- Spingere verso l'alto l'anello d'arresto della testa (fig. 2);
- Posizionare la testa perpendicolarmente alla valvola (fig. 3);
- Esercitando una lieve pressione con la mano, innestare la testa sull'adattatore: ciò avviene semplicemente premendo fino a quando non si sente uno scatto (fig. 4).

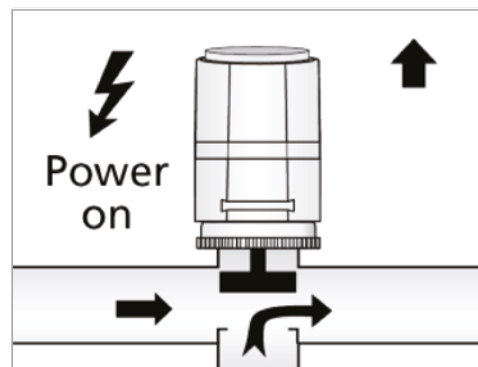
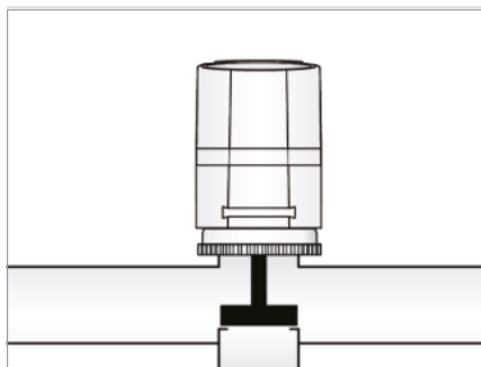

INDICAZIONI DI FUNZIONAMENTO

Con l'indicatore di funzionamento (indicatore circolare di colore azzurro) delle teste è possibile riconoscere con uno sguardo, e al buio sentire col tatto, se la valvola è aperta o chiusa. L'indicatore di funzionamento fuoriesce se la valvola si apre.

MESSA IN FUNZIONE DELLE TESTE TERMOELETTRICHE

Tutte le teste termoelettriche serie TE sono fornite in posizione bloccata e aperta per $\sim 1/4$.

Al momento della messa in servizio, per poter sbloccare la testa, deve essere data tensione per almeno 6 minuti (es. termostato collegato in posizione di riscaldamento). La testa durante questo periodo si aprirà completamente, e romperà il blocco.

A questo punto la testa è pronta per il suo normale funzionamento.

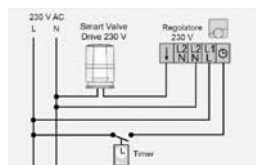

**TESTA TERMOELETTRICA
ART. TE 3010
COD. 69011051**

Teste termoelettriche 230V normalmente chiusa senza contatto di finecorsa.

Colore cavi elettrici di collegamento testa termoelettrica senza dispositivo di finecorsa con relativa descrizione.

COLORE FILO	DESCRIZIONE
marrone	cavo elettrico di collegamento testa termoelettrica alla "fase"
blu	cavo elettrico di collegamento testa termoelettrica al "neutro"

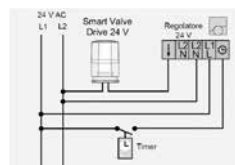

**TESTA TERMOELETTRICA
ART. TE 3011
COD. 69011052**

Teste termoelettriche 24V normalmente chiusa senza contatto di finecorsa.

Colore cavi elettrici di collegamento testa termoelettrica senza dispositivo di finecorsa con relativa descrizione.

COLORE FILO	DESCRIZIONE
marrone	cavo elettrico di collegamento testa termoelettrica alla "fase"
blu	cavo elettrico di collegamento testa termoelettrica al "neutro"

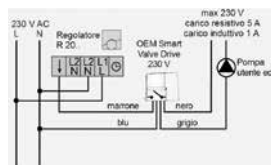

**TESTA TERMOELETTRICA
ART. TE 3012
COD. 69011056**

Teste termoelettriche 230V normalmente chiusa con contatto di finecorsa.

Colore cavi elettrici di collegamento testa termoelettrica con dispositivo di finecorsa con relativa descrizione.

COLORE FILO	DESCRIZIONE
marrone	cavo elettrico di collegamento testa termoelettrica alla "fase"
blu	cavo elettrico di collegamento testa termoelettrica al "neutro"
nero e grigio	cavi elettrici di uscita dal contatto ausiliario "finecorsa"

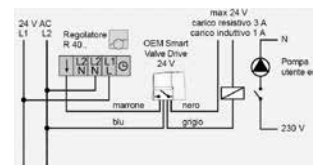

**TESTA TERMOELETTRICA
ART. TE 3013
COD. 69011057**

Teste termoelettriche 24V normalmente chiusa con contatto di finecorsa.

Colore cavi elettrici di collegamento testa termoelettrica con dispositivo di finecorsa con relativa descrizione.

COLORE FILO	DESCRIZIONE
marrone	cavo elettrico di collegamento testa termoelettrica alla "fase"
blu	cavo elettrico di collegamento testa termoelettrica al "neutro"
nero e grigio	cavi elettrici di uscita dal contatto ausiliario "finecorsa"

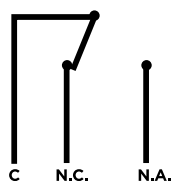

COLLEGAMENTI PER LE TESTE TERMOELETTRICHE

Le uscite dei termostati e/o cronotermostati alle quali collegare i cavi elettrici delle teste termoelettriche sono generalmente come quelle indicate nel seguente schema:

Dove:

C: entrata per il cavo di alimentazione proveniente dalla rete elettrica.

N.C.: uscita normalmente chiusa per il cavo di alimentazione proveniente dalla testa termoelettrica (non utilizzare in quanto la nostra testa termoelettrica è normalmente chiusa).

N.A.: uscita normalmente aperta per il cavo proveniente dalla testa termoelettrica (il cavo elettrico proveniente dalla testa termoelettrica di colore marrone deve essere collegato a questo tipo di uscita).

ESEMPIO DI APPLICAZIONE CON COLLEGAMENTI:

- 1 cronotermostato
- 1 testa termoelettrica

Ad ogni termostato o cronotermostato possono essere collegate in serie normalmente fino a 10 teste termoelettriche fra loro in parallelo. Per sapere esattamente quante teste è possibile collegare, occorre dividere il valore di portata del contatto di uscita N.A. del termostato, per l'assorbimento di spunto delle teste.

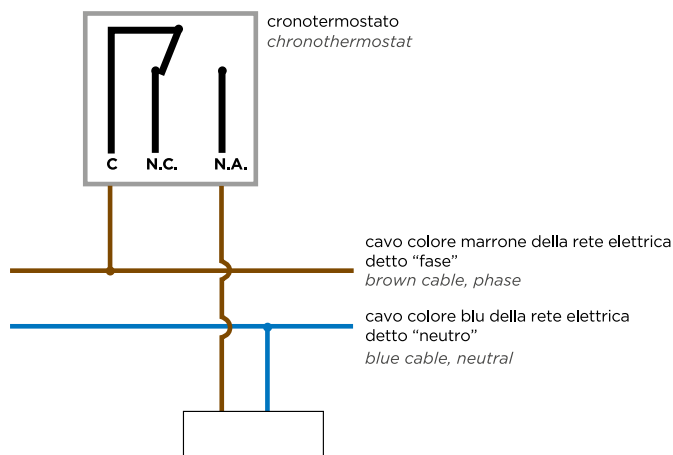

ESEMPIO DI APPLICAZIONE CON COLLEGAMENTI

- 1 cronotermostato
- 3 teste termoelettriche collegate in parallelo

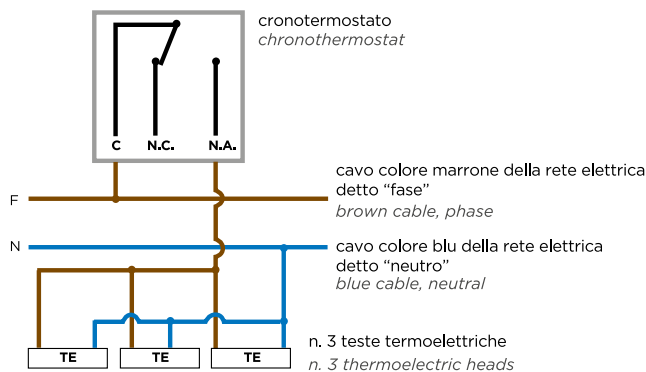

(fig. 1)

TESTE TERMOSTATICHE CON CONTATTO AUSILIARIO O "FINECORSA"

Il contatto ausiliario di finecorsa è utilizzato con lo scopo di dare avvio alla pompa di circolazione dell'impianto riscaldante quando c'è almeno una testa termoelettrica attiva (in funzione), e dunque impedire alla pompa di funzionare quando

tutte le valvole termostatiche sono chiuse. Questo dispositivo, disattivando la pompa quando non è possibile la circolazione nell'impianto, riduce l'usura della pompa stessa ed i rumori dovuti alla cavitazione.

Teste termoelettriche con contatto di fine corsa art. TE 3012
Thermostatic head with limit switch art. TE 3012

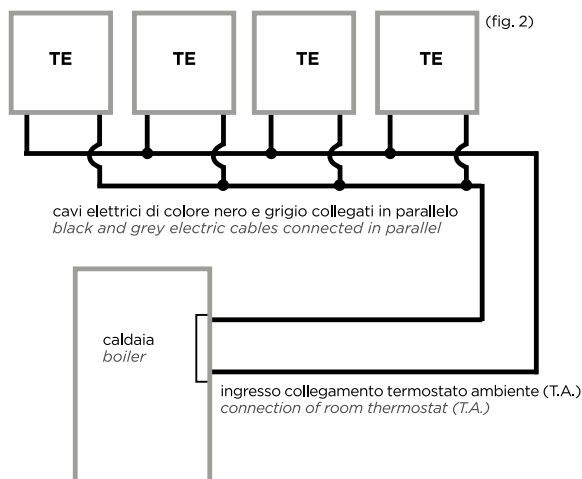

Teste termoelettriche con contatto di fine corsa art. TE 3012
Thermostatic head with limit switch art. TE 3012

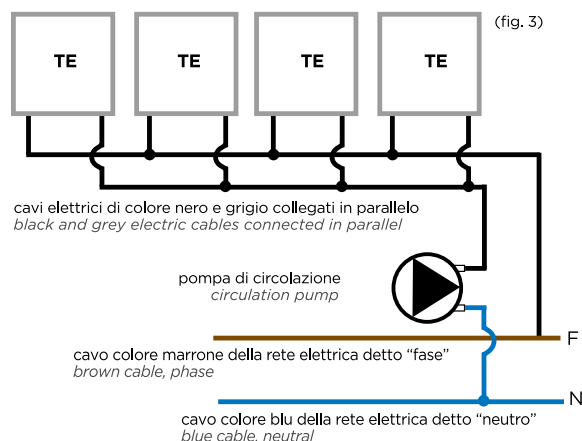

TESTE TERMoeLETTICHE

**TE 3010**

Testa termoelettrica 230 V
(normalmente in posizione di chiusura
- con tensione apre)

- tensione di alimentazione 230 VAC
- cavo di alimentazione 2 fili x 0,75 mm².

Lunghezza 1000 mm.

CODICE	MISURA			
69011051	M30x1,5	100	1	100

**TE 3011**

Testa termoelettrica 24 V
(normalmente in posizione di chiusura
- con tensione apre)

- tensione di alimentazione 24 VAC
- cavo di alimentazione 2 fili x 0,75 mm².

Lunghezza 1000 mm.

CODICE	MISURA			
69011052	M30x1,5	100	1	100

**TE 3012**

Testa termoelettrica 230 V con contatto
di finecorsa (normalmente in posizione
di chiusura - con tensione apre)

- tensione di alimentazione 230 VAC
- cavo di alimentazione 4 fili x 0,75 mm².

Lunghezza 1000 mm.

CODICE	MISURA			
69011056	M30x1,5	150	1	100

**TE 3013**

Testa termoelettrica 24 V con contatto
di finecorsa (normalmente in posizione
di chiusura - con tensione apre)

- tensione di alimentazione 24 VAC
- cavo di alimentazione 4 fili x 0,75 mm².

Lunghezza 1000 mm.

CODICE	MISURA			
69011057	M30x1,5	150	1	100

**VA 3090S**

Adattatore di ricambio per teste
termoelettriche serie TE.

CODICE	MISURA			
69015024	M30x1,5	8	-	-

TESTE TERMOELETTICHE



CARATTERISTICHE TECNICHE

Le teste termoelettriche per il loro funzionamento sfruttano la dilatazione di un elemento termosensibile, che al momento in cui la valvola deve essere aperta è scaldato tramite una resistenza elettrica. Questo funzionamento permette di avere un ciclo di apertura e chiusura lento, impedendo quindi all'impianto di subire "colpi d'ariete". Le teste termoelettriche devono essere collegate esclusivamente a termostati o cronotermostati del tipo on-off. Non si possono utilizzare termostati o cronotermostati a 3 punti o modulanti.

Le teste termoelettriche serie TE sono tutte del tipo normalmente chiuso. Le teste quindi si aprono solo quando dal sensore di comando (es. termostato) arriva il comando di apertura (tensione). Questo permette alla testa di lavorare solo quando c'è la necessità di passaggio di acqua calda o fredda attraverso il corpo scaldante e rimanere inattiva per tutto il restante periodo. Le nuove teste termoelettriche possono essere installate in qualunque posizione, anche capovolte, in quanto sono protette contro le eventuali perdite dei vitoni termostatici.

	TE 3110	TE 3111	TE 3112	TE 3113
tensione di alimentazione	230 V AC, +10%...-10%, 50/60 Hz	24 V AC/DC -10%...+20%, 0-60 Hz	230 V AC, +10%...-10%, 50/60 Hz	24 V AC/DC, +20%...-10%, 50/60 Hz
max corrente in entrata	300 mA per max 200 ms	250 mA per max 2 min	300 mA per max 200 ms	250 mA per max 2 min
potenza di esercizio	2 W	2 W	1,8 W	1,8 W
corsa di regolazione	4 mm	4 mm	4 mm	4 mm
forza di regolazione	100 N +10%	100 N +10%	90 N ±5%	90 N ±5%
tensione/corrente di commutazione microinteruttore	-	-	230 V AC: carico resistivo 5 A, carico induttivo 1 A	24 V AC/DC: carico ohmico 3 A, carico induttivo 1 A
punto di scatto NC	-	-	Ca. 3 mm	Ca. 3 mm
temperatura fluido	0÷100 °C	0÷100 °C	0÷100 °C	0÷100 °C
temperatura di stoccaggio	-25÷60 °C	-25÷60 °C	-25÷60 °C	-25÷60 °C
temperatura ambiente	0÷60 °C	0÷60 °C	0÷60 °C	0÷60 °C
grado di protezione	IP 54	IP 54	IP 54	IP 54
classe di protezione	II	III	II	III
conformità CE	EN 60730	EN 60730	EN 60730	EN 60730
materiale alloggiamento	Poliammide			
colore alloggiamento	Grigio			
cavi di alimentazione	2x0.75 mm ² PVC	2x0.75 mm ² PVC	4x0.75 mm ² PVC	4x0.75 mm ² PVC
colore cavo	Grigio			
lunghezza cavi	1 m	1 m	1 m	1 m
peso	100 g	100 g	Ca. 155 g	Ca. 155 g
resistenza alle sovratensioni conforme a EN 60730-1	2.5 kV	1 kV	2.5 kV	1 kV

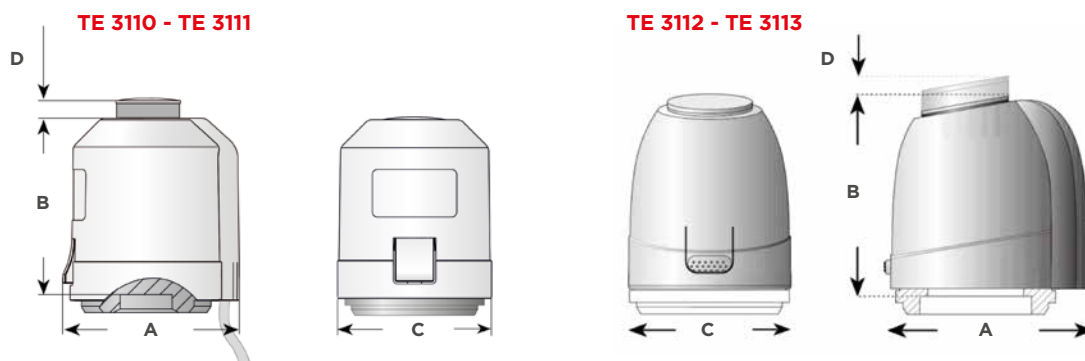

CODICE	ARTICOLO	MISURA	A	B	C	D	E	F	G	H
69011021	TE 3110	M30x1,5	50	54	44	5,5	-	M30x1,5	-	-
69011022	TE 3111		50	54	44	5,5	-		-	-
69011026	TE 3112		56	54	44	4	-		-	-
69011027	TE 3113		56	54	44	4	-		-	-

CURVE CARATTERISTICHE

TE 3110 - TE 3111

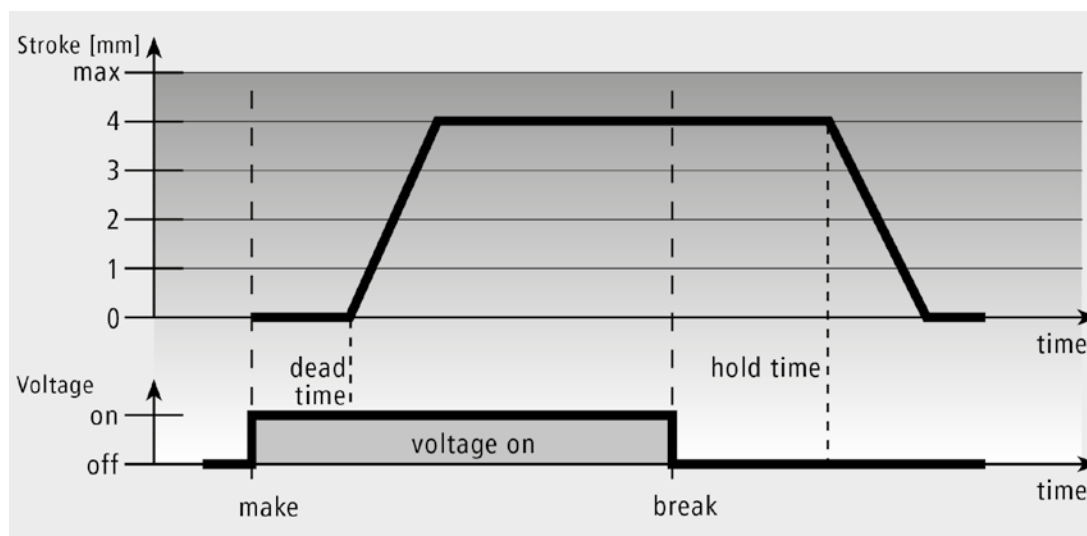

TE 3112 - TE 3113

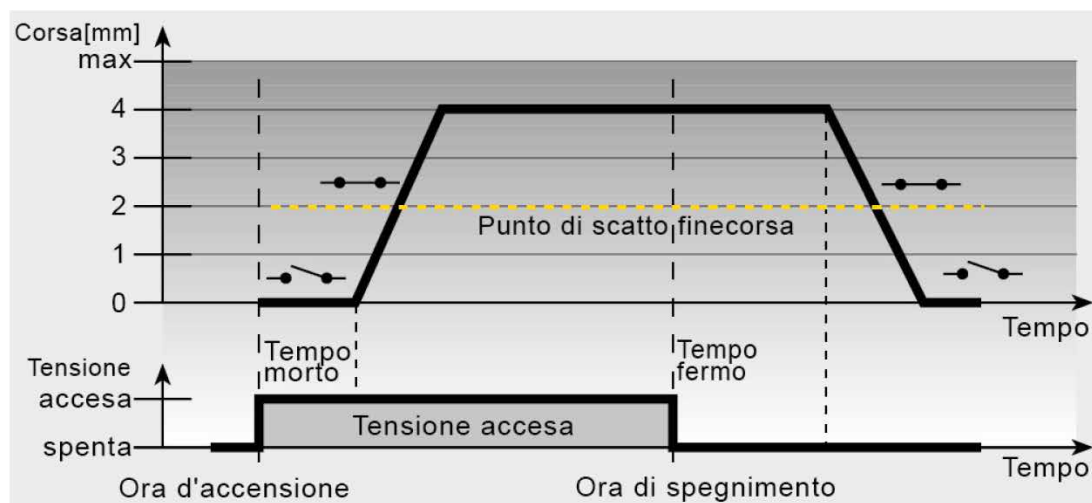

ISTRUZIONI DI MONTAGGIO: ASSEMBLAGGIO CON ADATTATORE PER VALVOLA

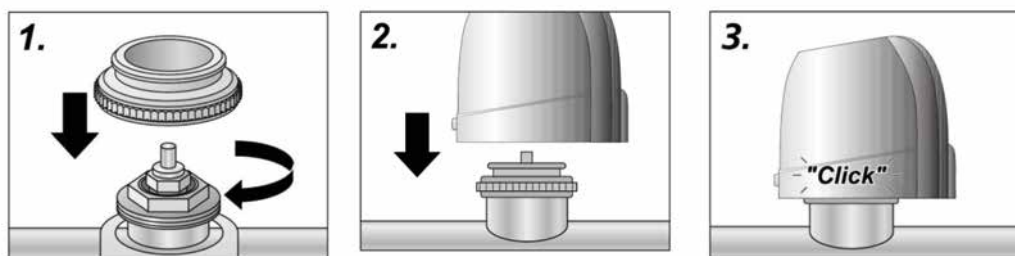

ISTRUZIONI PER IL MONTAGGIO DELLE TESTE TERMOELETTRICHE

- Avvitare a mano l'adattatore per valvole sulla valvola. (fig.1);
- Posizionare a mano, verticalmente, l'azionatore sull'adattatore per valvole. (fig.2);
- Esercitando con la mano una pressione verticale sull'azionatore, questo viene facilmente incastrato sull'adattatore per valvole; l'incastrò è chiaramente udibile. (fig.3).

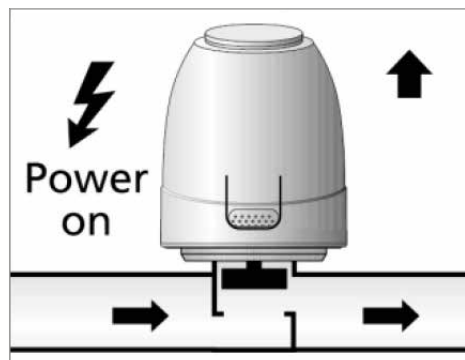
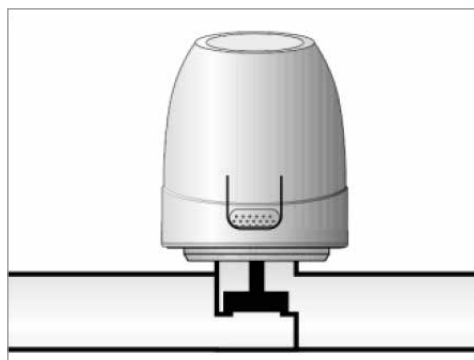

INDICAZIONI DI FUNZIONAMENTO

Con l'indicatore di funzionamento (indicatore circolare di colore azzurro o rosso) delle teste è possibile riconoscere con uno sguardo, e al buio sentire col tatto, se la valvola è aperta o chiusa. L'indicatore di funzionamento fuoriesce se la valvola si apre.

MESSA IN FUNZIONE DELLE TESTE TERMOELETTRICHE

Tutte le teste termoelettriche serie TE sono fornite in posizione bloccata e aperta per $\sim 1/4$.

Al momento della messa in servizio, per poter sbloccare la testa, deve essere data tensione per almeno 6 minuti (es. termostato collegato in posizione di riscaldamento). La testa durante questo periodo si aprirà completamente, e romperà il blocco.

A questo punto la testa è pronta per il suo normale funzionamento.

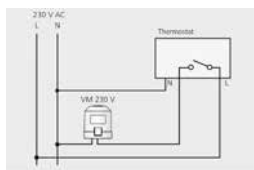

**TESTA TERMOELETTRICA
ART. TE 3110
COD. 69011021**

Teste termoelettriche 230V normalmente chiusa senza contatto di finecorsa.

Colore cavi elettrici di collegamento testa termoelettrica senza dispositivo di finecorsa con relativa descrizione.

COLORE FILO	DESCRIZIONE
marrone	cavo elettrico di collegamento testa termoelettrica alla "fase"
blu	cavo elettrico di collegamento testa termoelettrica al "neutro"

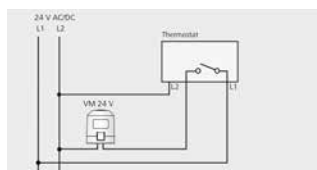

**TESTA TERMOELETTRICA
ART. TE 3111
COD. 69011022**

Teste termoelettriche 24V normalmente chiusa senza contatto di finecorsa.

Colore cavi elettrici di collegamento testa termoelettrica senza dispositivo di finecorsa con relativa descrizione.

COLORE FILO	DESCRIZIONE
marrone	cavo elettrico di collegamento testa termoelettrica alla "fase"
blu	cavo elettrico di collegamento testa termoelettrica al "neutro"

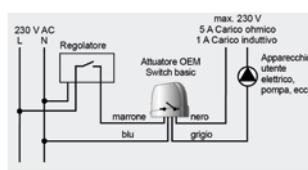

**TESTA TERMOELETTRICA
ART. TE 3112
COD. 69011026**

Teste termoelettriche 230V normalmente chiusa con contatto di finecorsa.

Colore cavi elettrici di collegamento testa termoelettrica con dispositivo di finecorsa con relativa descrizione.

COLORE FILO	DESCRIZIONE
marrone	cavo elettrico di collegamento testa termoelettrica alla "fase"
blu	cavo elettrico di collegamento testa termoelettrica al "neutro"
nero e grigio	cavi elettrici di uscita dal contatto ausiliario "finecorsa"

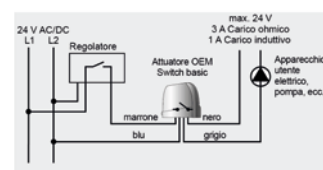

**TESTA TERMOELETTRICA
ART. TE 3113
COD. 69011027**

Teste termoelettriche 24V normalmente chiusa con contatto di finecorsa.

Colore cavi elettrici di collegamento testa termoelettrica con dispositivo di finecorsa con relativa descrizione.

COLORE FILO	DESCRIZIONE
marrone	cavo elettrico di collegamento testa termoelettrica alla "fase"
blu	cavo elettrico di collegamento testa termoelettrica al "neutro"
nero e grigio	cavi elettrici di uscita dal contatto ausiliario "finecorsa"

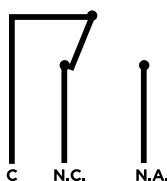

COLLEGAMENTI PER LE TESTE TERMOELETTRICHE

Le uscite dei termostati e/o cronotermostati alle quali collegare i cavi elettrici delle teste termoelettriche sono generalmente come quelle indicate nel seguente schema:

Dove:

C: entrata per il cavo di alimentazione proveniente dalla rete elettrica.

N.C.: uscita normalmente chiusa per il cavo di alimentazione proveniente dalla testa termoelettrica (non utilizzare in quanto la nostra testa termoelettrica è normalmente chiusa).

N.A.: uscita normalmente aperta per il cavo proveniente dalla testa termoelettrica (il cavo elettrico proveniente dalla testa termoelettrica di colore marrone deve essere collegato a questo tipo di uscita).

ESEMPIO DI APPLICAZIONE CON COLLEGAMENTI:

- 1 cronotermostato
- 1 testa termoelettrica

Ad ogni termostato o cronotermostato possono essere collegate in serie normalmente fino a 10 teste termoelettriche fra loro in parallelo. Per sapere esattamente quante teste è possibile collegare, occorre dividere il valore di portata del contatto di uscita N.A. del termostato, per l'assorbimento di spunto delle teste.

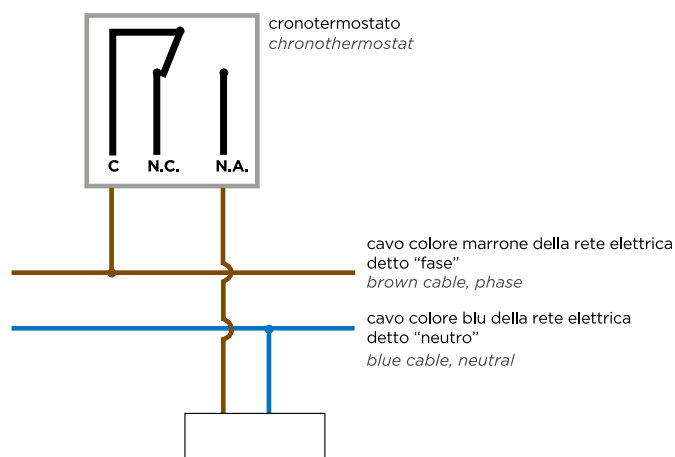

ESEMPIO DI APPLICAZIONE CON COLLEGAMENTI

- 1 cronotermostato
- 3 teste termoelettriche collegate in parallelo

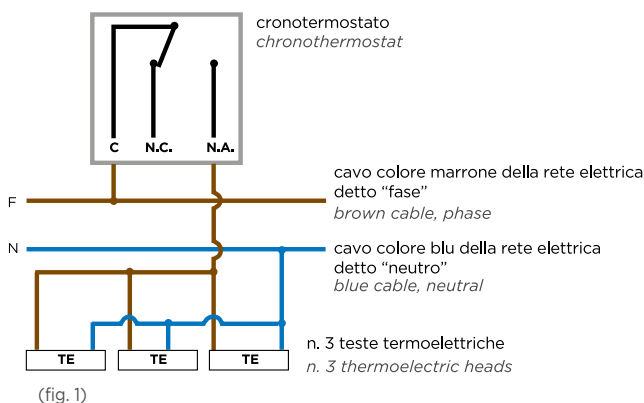

TESTE TERMOSTATICHE CON CONTATTO AUSILIARIO O "FINECORSA"

Il contatto ausiliario di finecorsa è utilizzato con lo scopo di dare avvio alla pompa di circolazione dell'impianto riscaldante quando c'è almeno una testa termoelettrica attiva (in funzione), e dunque impedire alla pompa di funzionare quando

tutte le valvole termostatiche sono chiuse. Questo dispositivo, disattivando la pompa quando non è possibile la circolazione nell'impianto, riduce l'usura della pompa stessa ed i rumori dovuti alla cavitazione.

Teste termoelettriche con contatto di fine corsa art. TE 3112
Thermostatic head with limit switch art. TE 3112

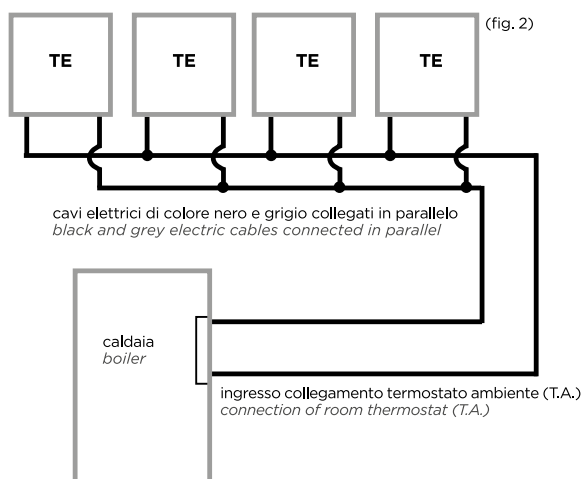

Teste termoelettriche con contatto di fine corsa art. TE 3112
Thermostatic head with limit switch art. TE 3112

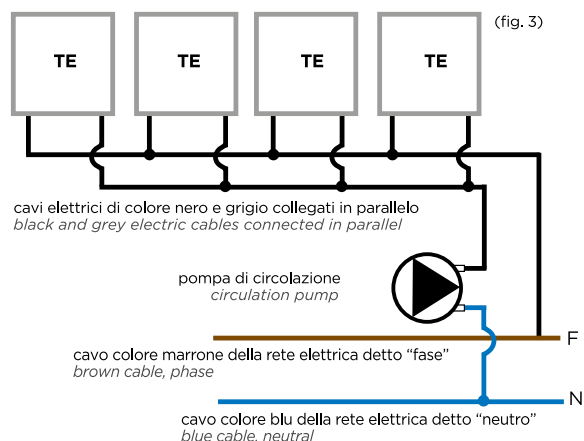

TESTE TERMOELETTRICHE

**TE 3110**

Testa termoelettrica 230 V
(normalmente in posizione di chiusura
- con tensione apre)

- tensione di alimentazione 230 VAC
- cavo di alimentazione 2 fili x 0,75 mm².

Lunghezza 1000 mm.

CODICE	MISURA			
69011021	M30x1,5	112	1	100

**TE 3111**

Testa termoelettrica 24 V
(normalmente in posizione di chiusura
- con tensione apre)

- tensione di alimentazione 24 VAC
- cavo di alimentazione 2 fili x 0,75 mm².

Lunghezza 1000 mm.

CODICE	MISURA			
69011022	M30x1,5	114	1	100

**TE 3112**

Testa termoelettrica 230 V con contatto
di finecorsa (normalmente in posizione
di chiusura - con tensione apre)

- tensione di alimentazione 230 VAC
- cavo di alimentazione 4 fili x 0,75 mm².

Lunghezza 1000 mm.



CODICE	MISURA			
69011026	M30x1,5	170	1	100

**TE 3113**

Testa termoelettrica 24 V con contatto
di finecorsa (normalmente in posizione
di chiusura - con tensione apre)

- tensione di alimentazione 24 VAC
- cavo di alimentazione 4 fili x 0,75 mm².

Lunghezza 1000 mm.

CODICE	MISURA			
69011027	M30x1,5	174	1	100

**VA 3090**

Adattatore di ricambio per teste
termoelettriche serie TE.

CODICE	MISURA			
69015023	M30x1,5	8	-	-

TERMOSTATI DI SICUREZZA A CONTATTO E AD IMMERSIONE

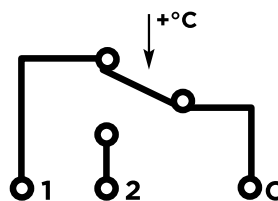

Collegamento elettrico
Electrical connection

CARATTERISTICHE TECNICHE

Termostato a contatto

Campo di regolazione della temperatura: 0 °C ÷ 90 °C

Gradiente termico: 1 °C/min

Tolleranza temperatura minima ±4 °C

Tolleranza temperatura massima ±6 °C

Differenziale: 8±12 °C

Portata nominale dei contatti:

- 16 (4)A 250 V-
- 6 (1)A 400 V-

Tensione impulsiva nominale 4 kV

Limite temperatura della testa di comando: 85 °C

Grado protezione: IP 40

Classe isolamento: I

Termostato ad Immersione

Campo di regolazione della temperatura: 10 °C ÷ 90 °C

Gradiente termico: 1 °C/min

Differenziale: 6±1 °C

Portata nominale dei contatti:

- 15 (6)A / 250 V-

Limite temperatura della testa di comando: 85 °C

Grado protezione: IP 40

Classe isolamento: I

CARATTERISTICHE COSTRUTTIVE

Il termostato di sicurezza serve a mantenere la temperatura dell'acqua in un impianto di riscaldamento entro assegnati valori e in particolare lontano dalla temperatura critica dell'acqua.

I termostati di sicurezza TS 3030, TS 3035, TS 3032, TS 3037 e TS 3050 sono termostati a contatto o a immersione.

Questi termostati possono avere un funzionamento sia normalmente aperto sia normalmente chiuso. La scelta sul tipo di funzionamento è fatta durante il collegamento elettrico.

Collegamento elettrico:

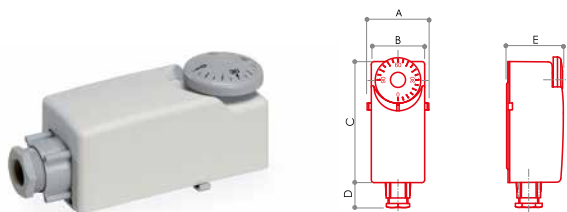

- Morsetto C: entrata comune;
- Morsetto 1: apre il circuito con l'aumentare della temperatura
- Morsetto 2: chiude il circuito con l'aumentare della temperatura

In generale, negli impianti di riscaldamento, l'utilizzatore è collegato ai morsetti C e 1 del termostato.



TS 3030

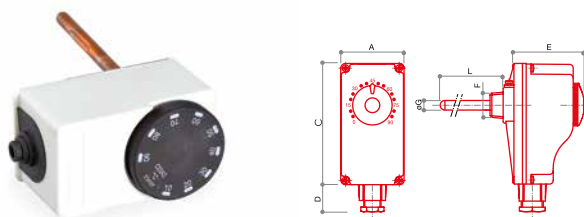

Termostato bimetallico di sicurezza a contatto: può essere impostato normalmente chiuso o aperto durante l'installazione.

CODICE	MISURA	A	B	C	D	E	F	G	H	L			
69011230	-	45	38	88	18	42	-	-	-	-	132	1	10



TS 3037

Termostato di sicurezza con sonda ad espansione di liquido ad immersione senza pozzetto: può essere impostato normalmente chiuso o aperto durante l'installazione.

CODICE	MISURA	A	B	C	D	E	F	G	H	L			
69011237	-	40	-	70	10	43	16	6,5	-	105	128	1	8

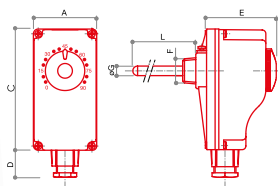
**TS 3035**

Termostato di sicurezza con sonda ad espansione di liquido ad immersione con pozzetto: può essere impostato normalmente chiuso o aperto durante l'installazione.

CODICE	MISURA	A	B	C	D	E	F	G	H	L			
69011235	G 1/2	40	-	70	10	43	16	6,5	-	105	128	1	8

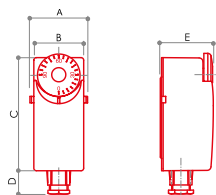
**TS 3032**

Termostato bimetallico di sicurezza a contatto precablato normalmente chiuso.

CODICE	MISURA	A	B	C	D	E	F	G	H	L			
69011232	-	45	38	88	18	42	-	-	-	-	250	1	8

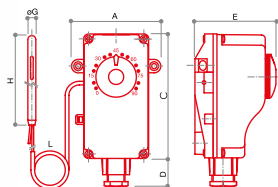
**TS 3050**

Termostato di sicurezza con sonda ad espansione di liquido ad immersione può essere normalmente chiuso o aperto durante l'installazione.

CODICE	MISURA	A	B	C	D	E	F	G	H	L			
69011250	-	40	-	70	10	43	-	6,5	73	1000	132	1	8

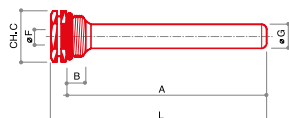
**PS 541**

Pozzetto giallo per sonda TS 3050 e TS 3037.

CODICE	MISURA	A	B	C	D	E	F	G	H	L			
9446952	G 1/2	100	10	22	-	-	7	12	-	108	84	20	160

POMPA DI CIRCOLAZIONE

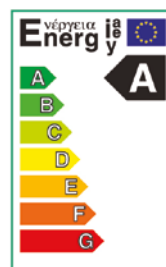

CARATTERISTICHE TECNICHE

	PCE 755	PCE 756	PCE 757
classe energetica	A	A	A
EEL	< 0,23	< 0,23	< 0,23
temperatura liquido	2 ÷ 95 °C	-10 ÷ 95 °C	-10 ÷ 90 °C
temperatura ambiente	0 ÷ 40 °C	0 ÷ 40 °C	0 ÷ 40 °C
max pressione	6 bar	6 bar	6 bar
max quantità glicole	20 %	20 %	20 %
attacchi filettati secondo	ISO 228 G 1"1/2	ISO 228 G 1"1/2	ISO 228 G 1"1/2
tensione alimentazione	230 V (-15%; 10%)	230 V (-15%; 10%)	230 V (-15%; 10%)
frequenza	50/60 HZ	50/60 HZ	50/60 HZ
protezione	IP X40D	IP 44	IP 44
classe isolamento	F	H	H

CURVE CARATTERISTICHE

PCE 755

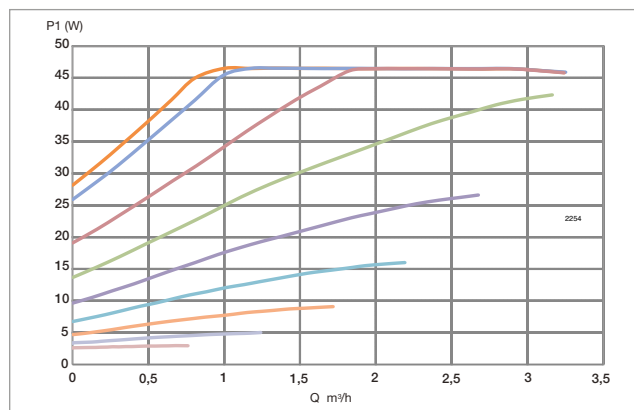
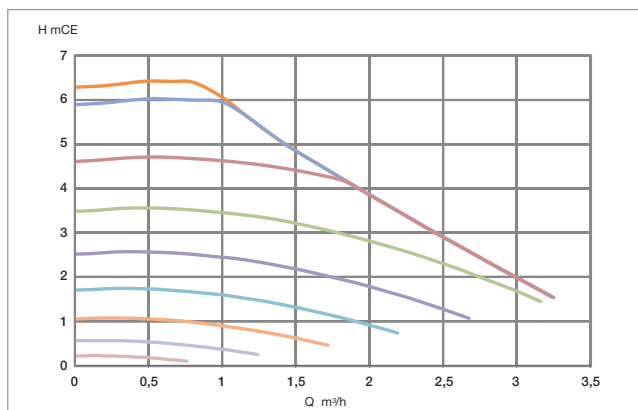

PCE 756

ΔP costante

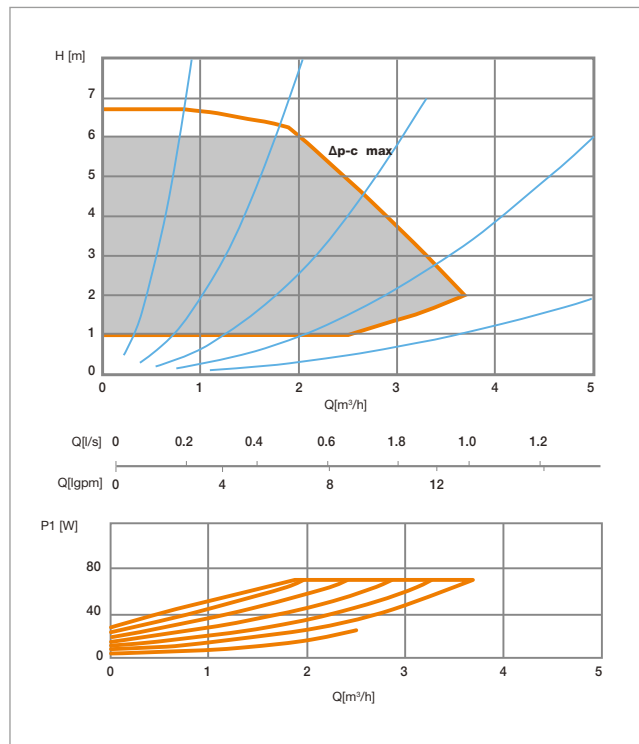

ΔP variabile

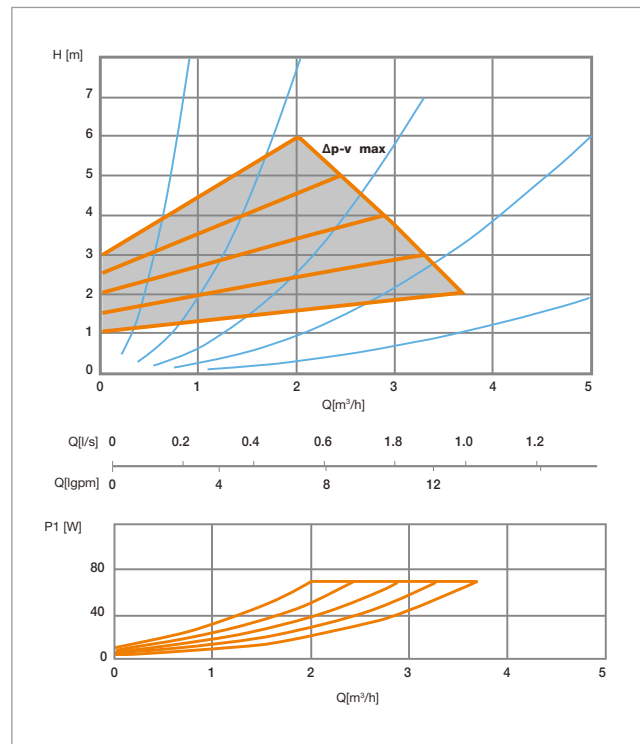

PCE 757

ΔP costante

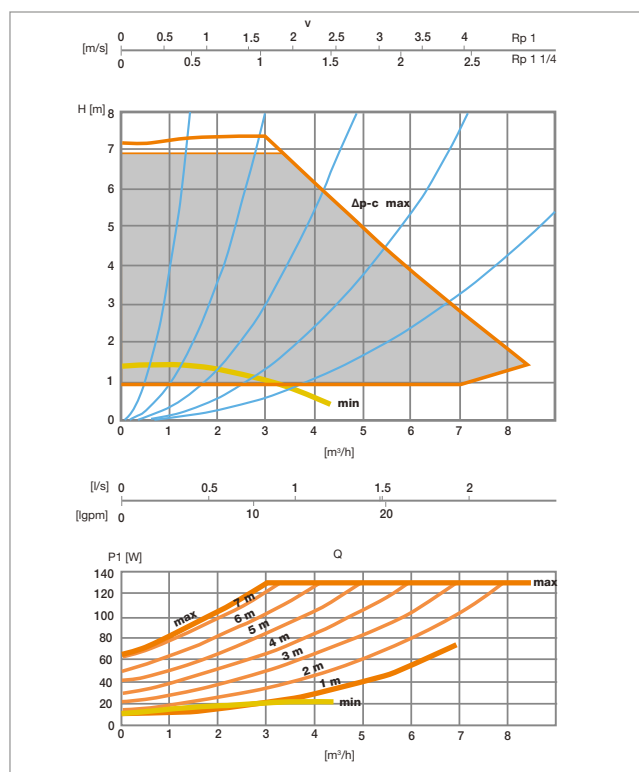

ΔP variabile

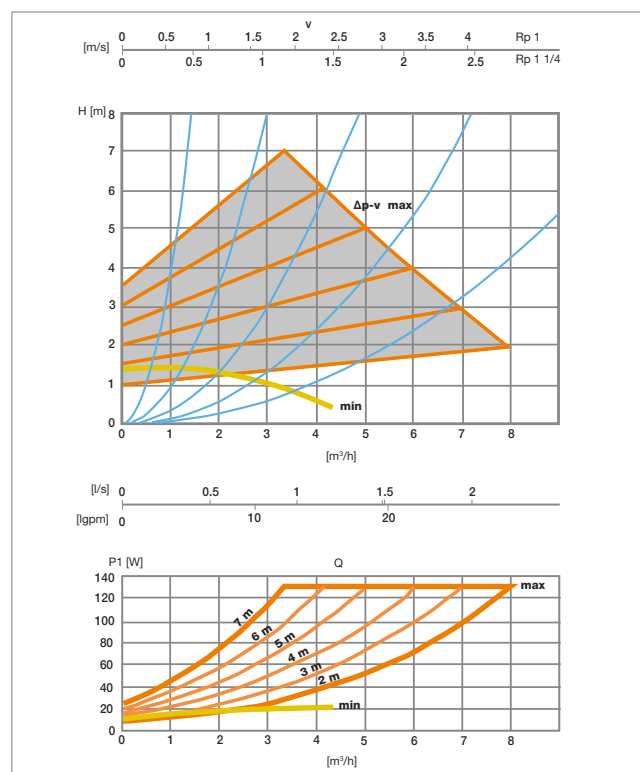

POMPA DI CIRCOLAZIONE

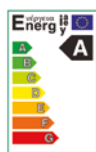
**PCE 755**

Pompa di circolazione elettronica con motore sincrono 25/60, interasse 130 mm.

CODICE	MISURA			
69011560	25/60-INT. 130 mm	1784	1	-

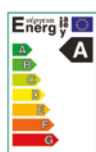
**PCE 756**

Pompa di circolazione elettronica con motore sincrono 25/70, interasse 130 mm.

CODICE	MISURA			
69011562	25/70-INT. 130 mm	2036	1	-

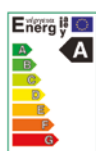
**PCE 757**

Pompa di circolazione elettronica con motore sincrono 25/80, interasse 180 mm.

CODICE	MISURA			
69011564	25/80-INT. 180 mm	3718	1	-

**VP 5012**

Valvole a sfera per pompe con attacco femmina G 1" e dado girevole da G 1"1/2.

CODICE	MISURA			
68559752	G 1"1/2 x G 1"	314	10	80

**TZ 800**

Tronchetto distanziatore zincato per collaudo impianti, interasse 130 mm.

CODICE	MISURA			
7116601	G 1"1/2	676	3	24

CENTRALINE DI TERMOREGOLAZIONE ELETTRONICHE DI TIPO CLIMATICO

**CE 1300**

Centralina di termoregolazione di tipo climatico estate/inverno completa di sonda esterna, sonda di mandata e sonda di comando remoto.

ARTICOLO IN ESAURIMENTO.

CODICE	MISURA			
69011425	-	596	1	-

**CE 1305**

Software su cd per la rilevazione e registrazione dei dati con adattatore seriale RS 232.

ARTICOLO IN ESAURIMENTO.

CODICE	MISURA			
69011427	-	120	1	-

**CE 1310**

Termostato umidostato ambiente per la regolazione delle temperature in tutte le zone con commutazione estate/inverno e controllo soglia massima umidità al 60%.

ARTICOLO IN ESAURIMENTO.

CODICE	MISURA			
69011432	230 V	130	1	-



24 V

CE 1320

Base di collegamento per la gestione dei termostati e delle teste termoelettriche con possibilità di collegare fino a 6 termostati e 15 testine.



230 V

CODICE	MISURA			
69015001	24 V	410	1	-
69011441	230 V	410	1	-

SERVOMOTORI

CARATTERISTICHE TECNICHE



Servomotori con desing moderno per valvole Luxor con segnale di uscita in commutazione, in combinazione con sistemi di regolazione per singolo ambiente. Forza di azionamento di 150 N. Lunga durata grazie alla tecnologia del motore passo-passo, elevata sicurezza funzionale e lunga durata utile prevista. Servomotori a basso consumo energetico con sistema di adattamento valvole. Installazione plug-in semplice. Custodia ermeticamente sigillata: IP54 per la posizione di installazione a 360° e quindi protezione al 100% in caso di fuoriuscite. Servomotori a basso rumore e senza bisogno di manutenzione. Montaggio sulle valvole mediante filettatura M30x1.5.

MATERIALI COSTRUTTIVI

Materiale dell'involucro / colore:

Poliamide, Grigio chiaro RAL 7035.

Coperchio del rivestimento / colore:

Policarbonato, Trasparente.

	SM 1346	SM 1348
tensione di alimentazione	230V AC -10...+10% 50...60 Hz	24V AC, -10...+20% 50 - 60 HZ
tensione di controllo	-	0-10 V/PWM
consumo energetico	< 20 MA	< 110 MA
corrente di standby	< 5 mA	10 MA
potenza di funzionamento	3.5 VA	2.6 VA / 1.4 W
corsa	8.5 mm	
tempo di marcia (4 mm / 5 mm)	15 s/mm	
forza di azionamento	150 N (-20% / +40%)	
temperatura di esercizio alla valvola	0÷100 °C	
temperatura di stoccaggio	-25÷70 °C	
temperatura ambiente	0÷50 °C	
grado di protezione	IP 54	
classe di protezione	II	III
conformità secondo CE	EN 60730	
display LC	-	per direzione funzionamento, posizione, voltaggio di controllo, errori
impostazione manuale	con cacciavite 0.3 x 2 mm	
cavi di alimentazione	3x0.75 mm ² PVC, bianco	3x0.22 mm ² PVC, bianco
lunghezza cavi alimentazione	1 m	

ISTRUZIONI OPERATIVE

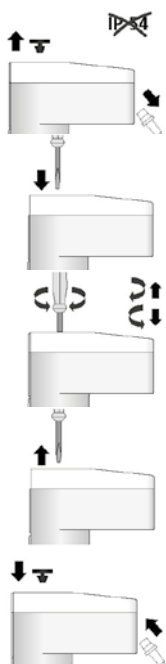
IMPOSTAZIONE MANUALE DELLA CORSA

1. Rimuovere la cavo di connessione e il tappo di protezione.

2. Introdurre il cacciavite da 0,3 x 2 mm nel dispositivo di regolazione della corsa manuale.

3. Girare a destra o a sinistra per estrarre o ritrarre.

4. Rimuovere il cacciavite dopo aver raggiunto la posizione desiderata.

5. Installare la protezione protettiva e collegare il cavo di connessione.

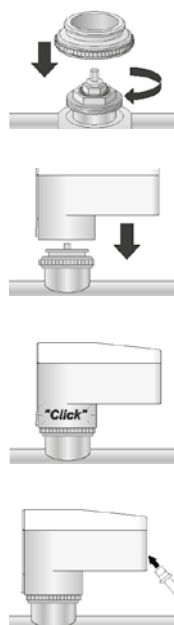
INSTALLAZIONE CON L'ADATTATORE

1. Avvitare manualmente l'adattatore della valvola sul vitone.

2. Posizionare manualmente il servomotore in posizione verticale sull'adattatore.

3. Agganciare manualmente il servomotore all'adattatore della valvola applicando una pressione verticale fino a sentire il tipico "click".

4. Collegare il cavo di connessione al servomotore.

POSIZIONE DI INSTALLAZIONE

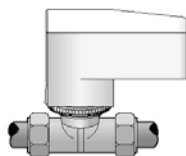

VERTICALE

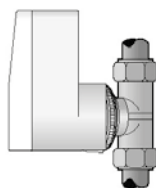

ORIZZONTALE

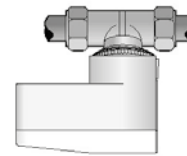

CAPOVOLTO

Il servomotore può essere utilizzato in ogni posizione di installazione.

Le posizioni preferite di installazione da utilizzare, dove possibile, sono orizzontale o verticale.

L'installazione "capovolto", in circostanze particolari (ad esempio acqua di scarico), può ridurre la durata del servomotore.

DIAGRAMMI DI FUNZIONAMENTO

SM 1346

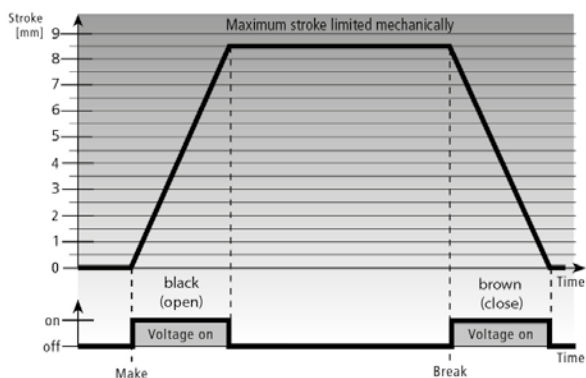

SM 1348

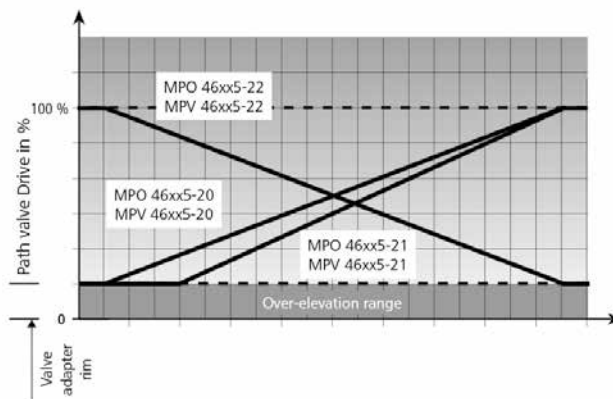

COLLEGAMENTI ELETTRICI

SM 1346

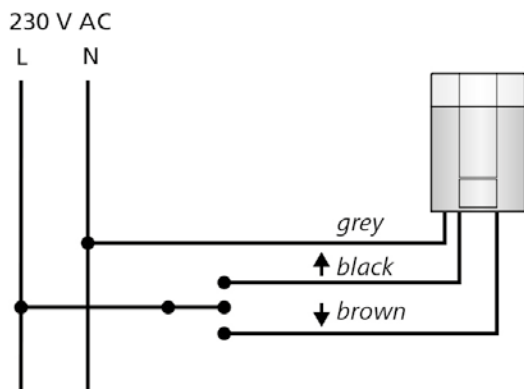

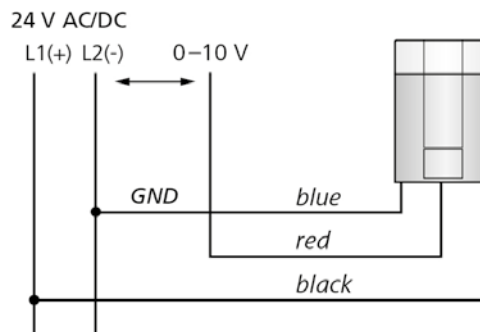

SM 1348

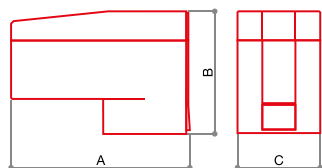

SERVOMOTORI



**SM 1346**

Servomotore a 3 punti con alimentazione 230 V e con attacco M30x1,5.

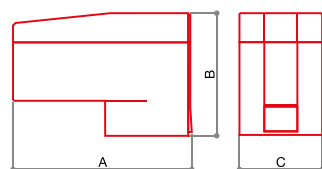
CODICE	MISURA	A	B	C	D	E	F	G	H	L			
69011717	230 V	90	65	44	-	-	-	-	-	-	208	1	-

**SM 1348**

Servomotore modulante 0-10 V con alimentazione 24 V e con attacco M30x1,5.

CODICE	MISURA	A	B	C	D	E	F	G	H	L			
69011719	24 V 0-10V	90	65	44	-	-	-	-	-	-	163	1	-

AZIONATORE PER LA REGOLAZIONE TEMPERATURA AMBIENTE



Chi realizza impianti di riscaldamento, ventilazione e raffreddamento richiede una tecnologia economica e allo stato dell'arte per garantire la sicurezza dei progetti sviluppati. Gli azionatori TE 3020 di Luxor, con "Diretto Controllo Digitale" per tensioni di esercizio da 0 a 10 Volt, presentano le seguenti vantaggiose caratteristiche:

- **modulanti:** regolazione continua e permanente con azionamenti da 0 a 10 Volt;
- **calibrazione automatica:** autoregolazione con rilevamento del punto 0 per la compensazione della tolleranza;
- **facilità di manutenzione:** indicatore di osservazione;
- **silenziosi:** principio termoelettrico;
- **lunga vita operativa:** resistenti all'usura, non richiedono manutenzione e garantiscono la sicurezza operativa;
- **economici:** ottimo rapporto prestazioni/prezzo.

CARATTERISTICHE TECNICHE

Tipo: normalmente chiuso
 Tensione di alimentazione: 24V AC, -10%...+20%, 50-60 Hz
 Max corrente di spunto: <math>< 320 \text{ mA}</math> durante 2 min. max.
 Potenza di esercizio: 1 W
 Tensione di controllo: 0-10 V DC
 Resistenza di ingresso: 100 k Ω
 Corsa di lavoro: 4 mm (minus 0.5 mm over-elevation)
 Forza di spinta: 100 N +5%
 Temperatura fluido: 0÷100 °C
 Temperatura di stoccaggio: -25÷60 °C
 Temperature ambiente: 0÷60 °C
 Grado di protezione: IP 54
 Classe di protezione: III
 Conformità CE secondo: EN 60730
 Materiale: Poliammide bianco
 Cavi di alimentazione: 3x0.22 mm² PVC
 Lunghezza cavi alimentazione: 1 m

CURVE CARATTERISTICHE

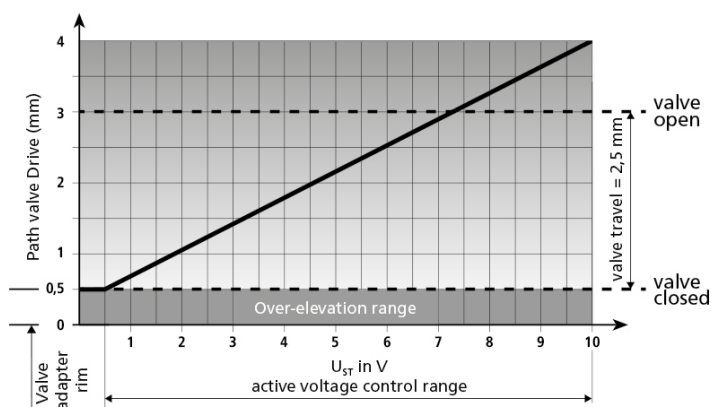

ISTRUZIONI OPERATIVE

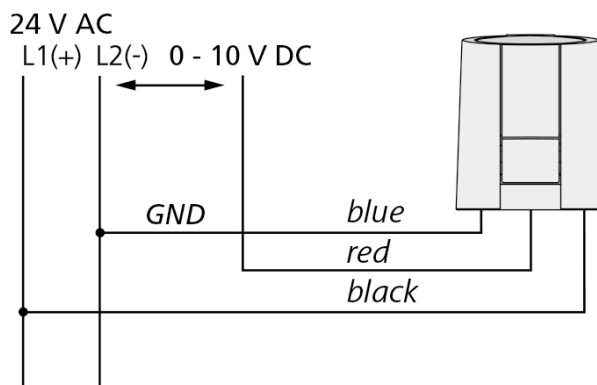

Montati su valvole di controllo, gli azionatori TE 3020 eseguono come elementi di regolazione modulanti (continui) molteplici compiti di azionamento e regolazione.

L'azionamento da 0 a 10 Volt è trasformato proporzionalmente in una corsa da 0 a 4 mm.

Il riscaldamento elettrico dell'elemento di lavoro a cera è rego-

lato dall'elettronica integrata. In base alla tensione di esercizio applicata, la valvola si apre silenziosamente mediante il sollevamento dell'elemento di lavoro a cera. L'azionatore TE 3020 raggiunge la sua corsa massima con tensioni di esercizio superiori a 10 Volt.

INSTALLAZIONE CON L'ADATTATORE



1. Avvitare manualmente l'adattatore della valvola sulla valvola stessa.

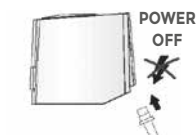

2. Collegare il cavo di alimentazione all'attuatore.

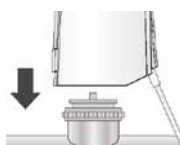

3. Posizionare manualmente l'attuatore in posizione verticale sull'adattatore della valvola.



4. Agganciare l'attuatore all'adattatore della valvola applicando manualmente la pressione verticale finché non si sente un click.

Gli attuatori TE 3020 sono dotati del funzionamento "first open", ossia l'attuatore al momento della consegna si trova nello stato normalmente aperto. Questo permette di effettuare il lavaggio e il riempimento dell'impianto a testine già montate, anche prima dei cablaggi elettrici. Nella messa in funzione che segue, l'applicazione di tensione di esercizio (per più di 6 minuti) provoca lo scatto automatico del funzionamento "first open" e l'attuatore è così pronto per il funzionamento.

POSIZIONE DI INSTALLAZIONE

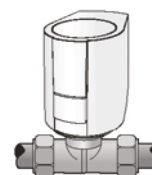

VERTICALE

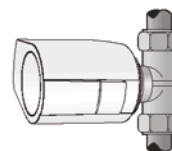

ORIZZONTALE

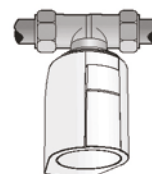

CAPOVOLTO



L'attuatore può essere installato in qualsiasi posizione, tuttavia le posizioni consigliate sono la verticale e orizzontale.

La posizione "capovolto" in alcune circostanze, es. gocciolamento, potrebbero ridurre la durata del dispositivo

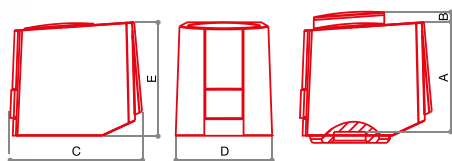
AZIONATORE PER LA REGOLAZIONE TEMPERATURA AMBIENTE

**TE 3020**

Azionatore per la regolazione
temperatura ambiente.
Testa termoelettrica 0-10 Volt.

CODICE	MISURA	A	B	C	D	E	F	G	H	L			
69011420	M30x1,5	51.1	7	61.5	44.3	53	-	-	-	-	150	1	-



6 / SISTEMA IDRONICO MODULARE

SISTEMA IDRONICO MODULARE



Il Sistema Idronico Modulare è composto da:

- un collettore modulare di distribuzione;
- gruppi di rilancio;
- gruppi di miscelazione e rilancio a punto fisso;
- gruppi di miscelazione e rilancio a temperatura scorrevole.

Il Sistema Idronico Modulare SIM 1208 è impiegato nella distribuzione e gestione di impianti a zone. È stato progettato per creare una serie di soluzioni volte a semplificare e risolvere diverse problematiche impiantistiche. Tutti i componenti del gruppo a contatto con l'acqua sono in ottone o in acciaio inox e le guarnizioni in EPDM perossidico. L'utilizzo di questi metalli permette di evitare la corrosione bimetallica, che si manifesta con metalli di diversa nobiltà.

Il collettore può essere allacciato alla caldaia da qualunque direzione: da sinistra, da destra, da sopra oppure da sotto. In questo modo è possibile collegare contemporaneamente più fonti di energia, come una caldaia e un gruppo frigo. Tutto il sistema è facilmente assemblabile in cantiere. Il collettore è modulare, in questo modo lo si può comporre con il numero di moduli necessario all'impianto. Ogni modulo del collettore può essere assemblato in modo da avere gli attacchi dei gruppi da destra oppure da sinistra, adeguando il sistema agli impianti già realizzati.

Sugli attacchi liberi del collettore è possibile installare: termomanometri, valvole di sfogo aria e valvole di carico/scarico acqua, vasi d'espansione e gruppi di sicurezza.

Ogni gruppo di rilancio e miscelazione è installabile con gli attacchi destri oppure sinistri. Ogni gruppo di rilancio e/o miscelazione è provvisto di termometri per la lettura delle temperature di mandata e ritorno, di valvola di bypass differenziale per la pompa installata sui gruppi, di sedi per sonde di regolazione e lettura. I gruppi di miscelazione possono essere collegati direttamente alla caldaia (senza collettore) e fungere da gruppo di rilancio e miscelazione.

I gruppi di miscelazione sono dotati di valvola miscelatrice a pistone a 3 vie, predisposta per la regolazione a punto fisso o scorrevole. La valvola miscelatrice è dotata anche di 2 bypass, uno prima e uno dopo la miscelazione. I gruppi di miscelazione sono dotati di un termostato di sicurezza con sonda e pozzetto ad immersione. Il SIM 1208 è installabile in cassetta metallica e/o a muro per mezzo delle apposite staffe in metallo.

Il SIM 1208 è estremamente compatto in tutte le dimensioni. In 700 mm di larghezza si possono installare fino a 5 gruppi da G 1"1/4; se l'allaccio della caldaia avviene su un lato, i gruppi possono diventare 6. Con le pompe posizionate in orizzontale, la profondità del gruppo è di soli 100 mm.

CARATTERISTICHE TECNICHE

Pressione massima di esercizio 6 bar
 Temperatura massima di esercizio 80 °C
 Kvs miscelatrice 5,5 (ricircolo) - 6,9 (scambio primario)

CARATTERISTICHE COSTRUTTIVE

Collettore

Materiale collettore:
 Ottone CB 753 S UNI EN 1982-2000 per rubinetteria
 Materiale kit di collegamento moduli:
 CW614N UNI EN 12164:2016
 Materiale guarnizioni:
 EPDM perossidico

Miscelatrice

Materiale corpo flussimetro:
 Ottone CB 753 S UNI EN 1982-2000 per rubinetteria
 Materiale guarnizioni:
 EPDM perossidico
 Componenti in ottone del vitone:
 CW614N UNI EN 12164:2016
 Componenti in acciaio del vitone:
 Acciaio inox

Gruppo portasonde

Materiale corpo:
 Ottone CB 753 S UNI EN 1982-2000 per rubinetteria
 Materiale componenti:
 CW614N UNI EN 12164:2016
 Portata massima consigliata sulla miscelatrice 2.750 l/h
 (Δp 0,25bar)
 Range termometro 0 ÷ 80 °C

Termometri

Cassa e gambo termometro: Acciaio zincato
 Copertura: Materiale plastico trasparente
 Elemento termometrico: molla a spirale bimetallica

Pompe

Wilo Yonos Para RS 25/6-130-FSM-RKA-12
 Wilo Stratos Para 25/1-7-130 T3
 Wilo Stratos Para 25/1-8-180 T3

TRATTAMENTI GALVANICI

Finitura nichelata

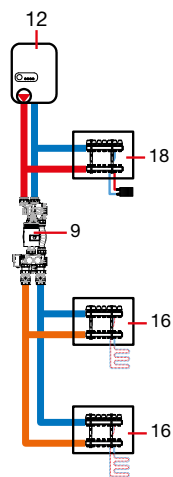
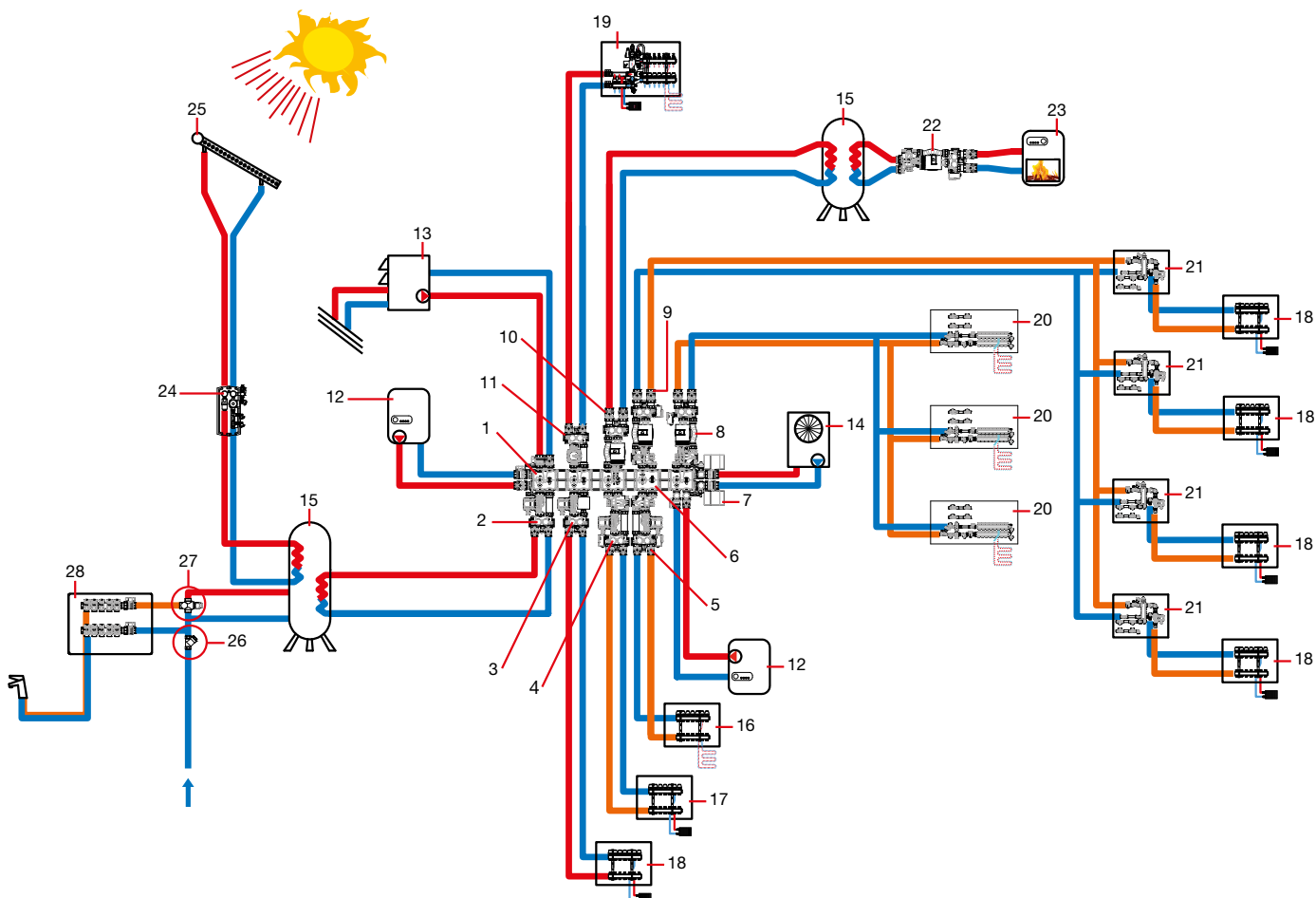

- 1 Collettore CD 1210
- 2 Gruppo di rilancio G 1" GR 1220-GR 1230
- 3 Gruppo di rilancio G 1" GR 1220-GR 1230, con contattorie da G 3/4 interasse 110 mm
- 4 Gruppo di miscelazione G 1" installato con mandata a sx GM 1260-GM 1270
- 5 Gruppo di miscelazione G 1" installato con mandata a dx GM 1260-GM 1270
- 6 Modulo del collettore CD 1210 assemblato rovescio per inversione attacchi del gruppo di rilancio/miscelazione (mandata dx)
- 7 Valvola di zona VZ 700
- 8 Gruppo di miscelazione G 1"1/4 installato con mandata a dx GM 1260 - GM 1270
- 9 Gruppo di miscelazione G 1"1/4 installato con mandata a sx GM 1260 - GM 1270
- 10 Gruppo di rilancio G 1"1/4 GR 1220 - GR 1230
- 11 Gruppo di rilancio G 1" GR 1220 - GR 1230
- 12 Caldaia
- 13 Pompa di calore
- 14 Gruppo frigo
- 15 Bollitore
- 16 Collettore CD 2468 per la distribuzione in un impianto a pannelli radianti
- 17 Collettore CD 2468 per la distribuzione in un impianto con Fan Coil
- 18 Collettore CD 2468 per la distribuzione in un impianto con radiatori
- 19 Gruppo premontato CCBAP 4037 completo di distribuzione per alta temperatura, miscelazione a punto fisso e rilancio
- 20 Gruppo premontato MC 5001 con predisposizione per la contabilizzazione riscaldamento /sanitario, valvola deviatrice e collettori di distribuzione
- 21 Gruppo premontato MC 5003 con predisposizione per la contabilizzazione riscaldamento /sanitario, separatore idraulico e pompa di rilancio
- 22 Gruppo di miscelazione G 1"1/4 con punto fisso per ricircolo delle caldaie a combustibile solido
- 23 Caldaia a combustibile solido
- 24 Gruppo di circolazione per pannelli solari GSP 1180
- 25 Pannello solare termico
- 26 Filtro RF 5008
- 27 Miscelazione sanitaria VM 660
- 28 Collettori sanitari

DISEGNO DIMENSIONALE

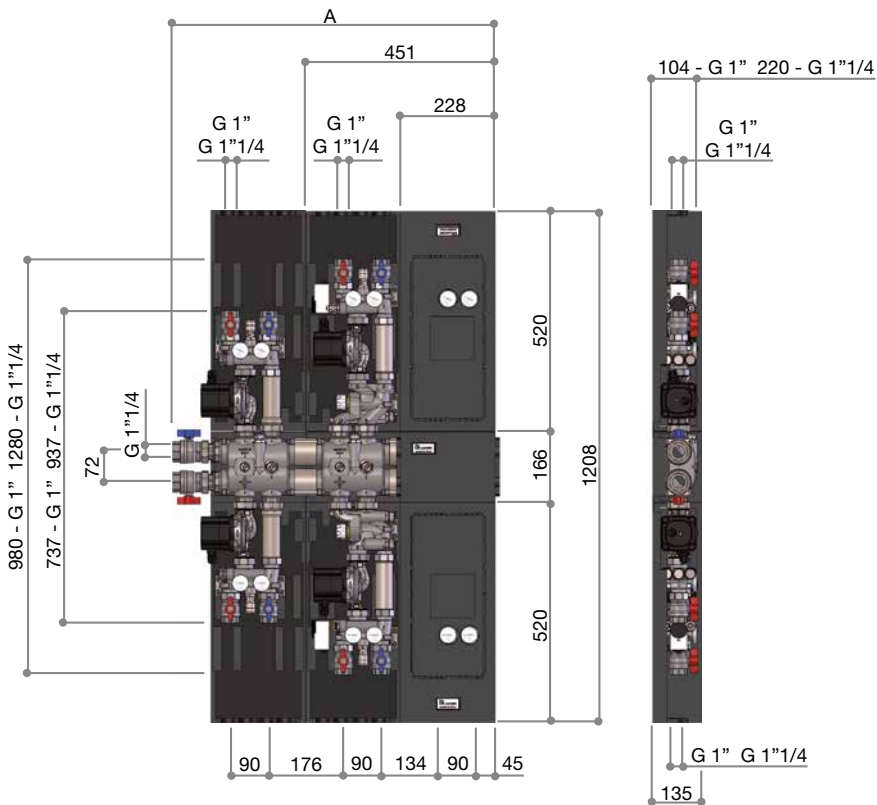
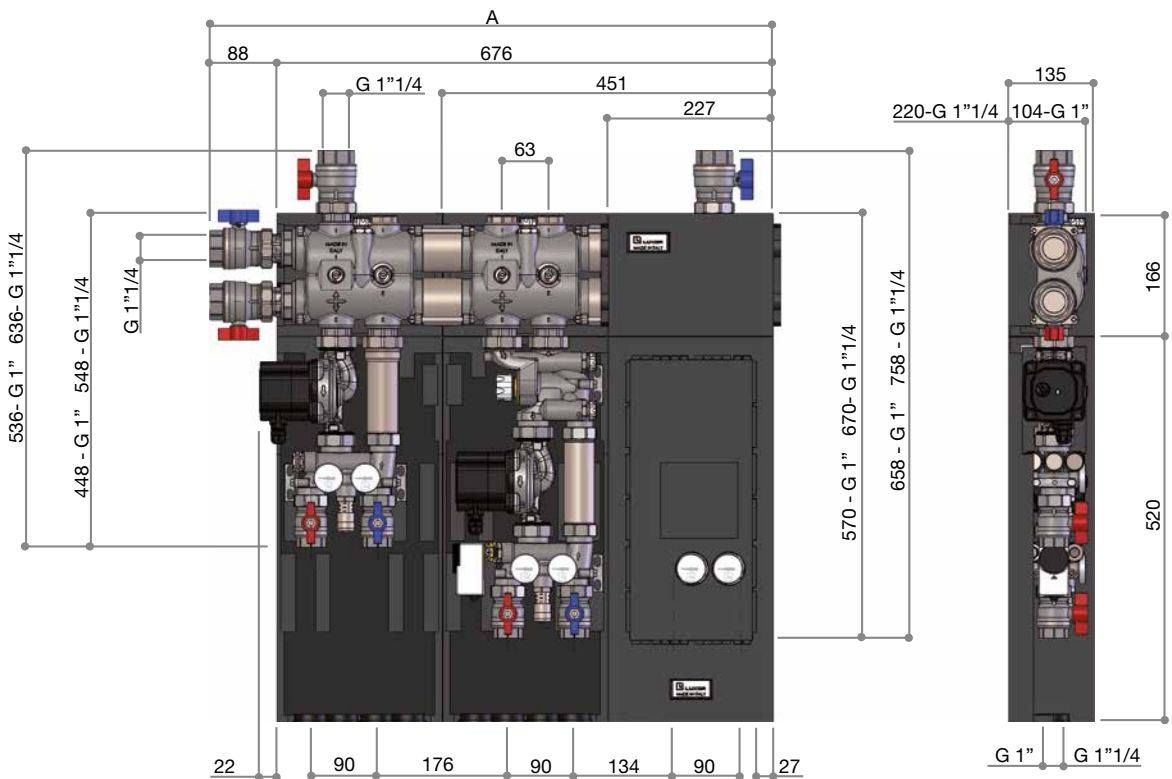

COLLETTORI

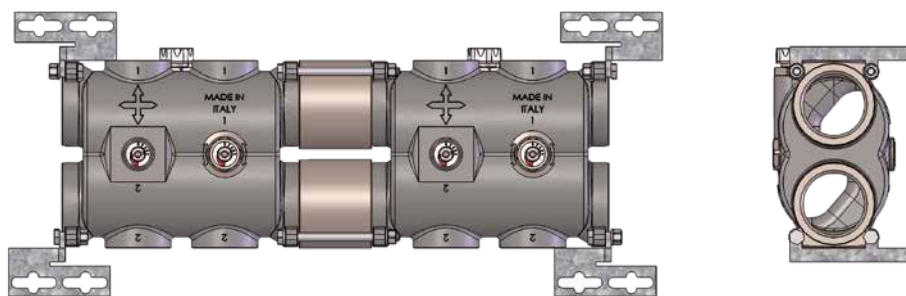

Collettore modulare da G 1" 1/2, con attacchi per i gruppi da G 1" 1/4 e valvole di bypass e bilanciamento.

Possibilità di aprire il bypass installato su tutti i moduli, in modo da funzionare anche come separatore idraulico.

Passaggio interno libero Ø 45 mm
Attacchi al circuito primario da G 1"1/2.

Attacchi ai gruppi di rilancio e miscelazione da G 1"1/4.

DISEGNO DI FLUSSO

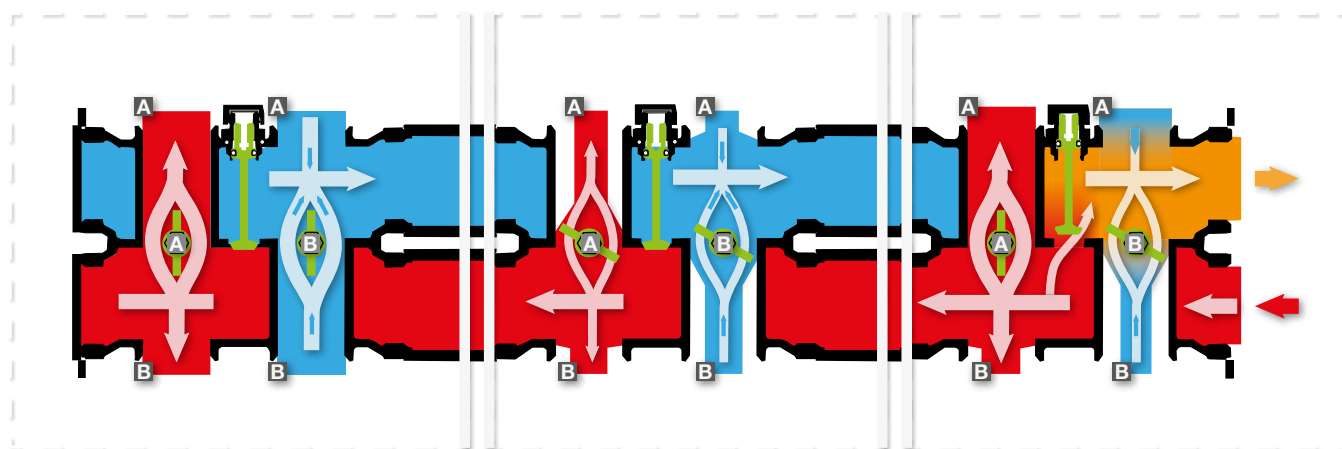

Modulo collettore con:

- A. Valvola di bilanciamento tutta aperta
- B. Valvola di bilanciamento tutta aperta

Modulo collettore con:

- A. Valvola di bilanciamento parzialmente aperta
- B. Valvola di bilanciamento parzialmente aperta

Modulo collettore con:

- A. Valvola di bilanciamento tutta aperta
- B. Valvola di bilanciamento parzialmente aperta

CARATTERISTICHE IDRAULICHE DEL COLLETTORE CD 1210

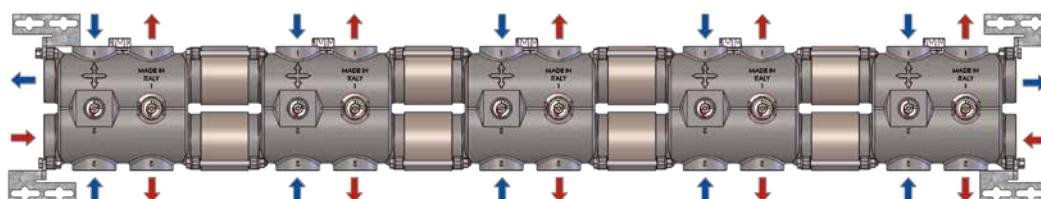

Il collettore CD 1210, se assemblato tutto nello stesso verso, ha un funzionamento idraulico uguale a quello di un classico collettore complanare con gli attacchi alternati su entrambi i lati del collettore e attacchi principali di testa da G 1"1/2.

Se necessario, è possibile assemblare il collettore in modo da invertire le uscite. Nell'immagine seguente, il terzo e il quarto modulo sono invertiti.

L'inversione si ottiene ruotando il modulo del collettore di 180°. Gli ingressi di testa sul collettore e su tutti gli altri moduli rimarranno invariati.

Questa possibilità è molto utile nel caso si debbano adeguare gli attacchi del collettore ad impianti preesistenti.



DIAGRAMMA DI PORTATA COLLETTORI



Kvs	N. VIE	POS
25	2	1
24	3	2
23	4	3
21	5	4

PROSPETTO VALORI KV BYPASS E VALVOLA DI BILANCIAMENTO

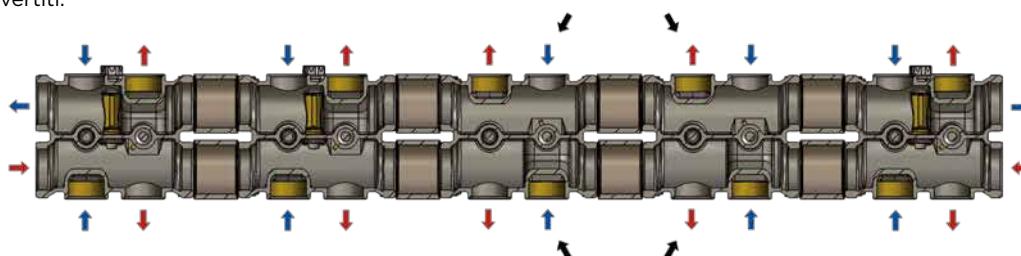
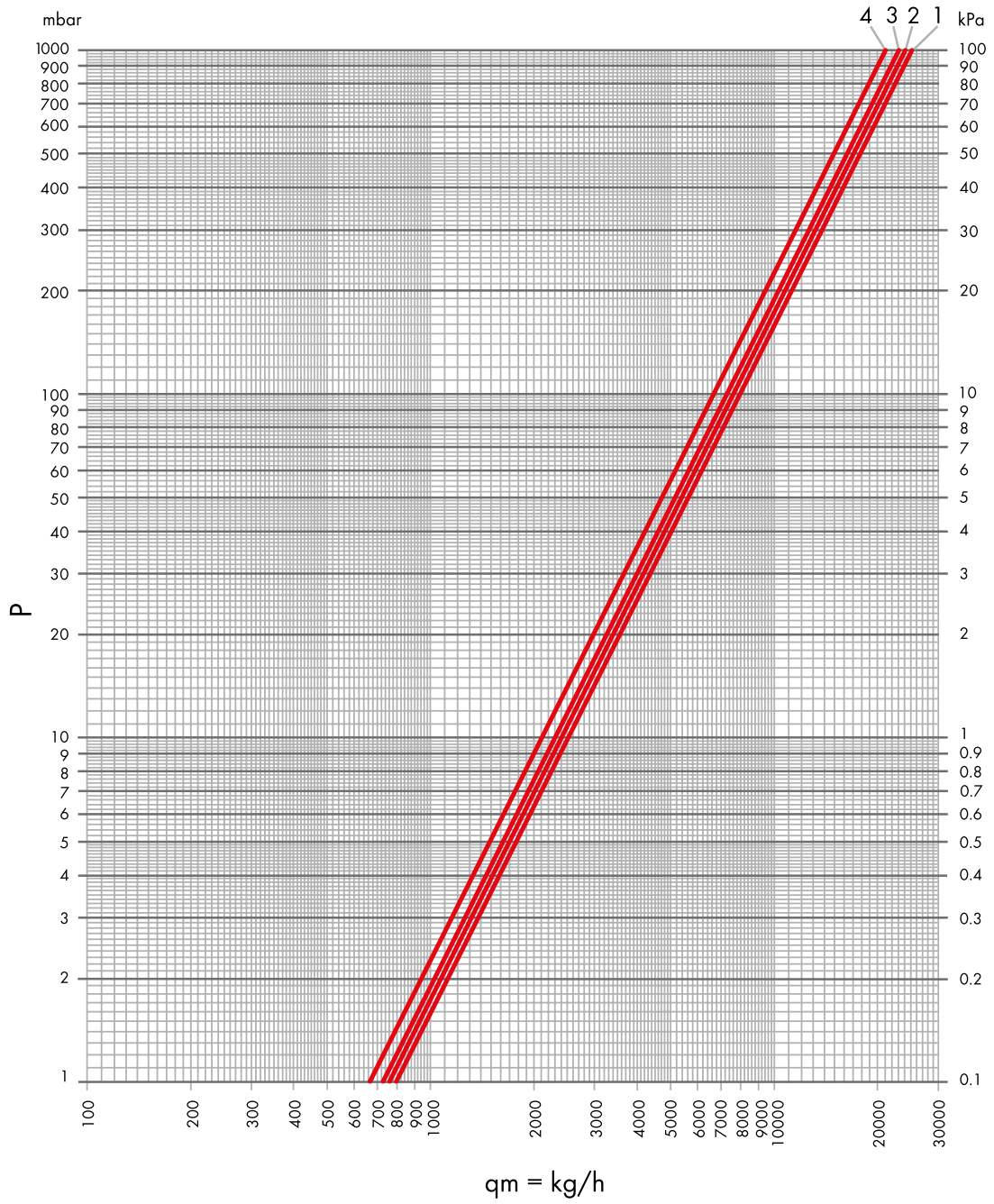
BYPASS

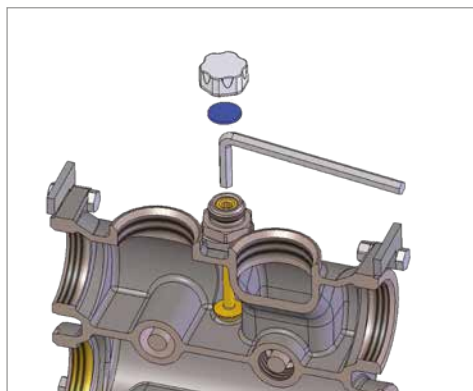

N.GIRI DELLA CHIUSURA	Kv
1/4	0,17
1/2	0,51
1	1,27
1"1/2	1,87
2	2,55
2"1/2	3,05

N.GIRI DELLA CHIUSURA	Kv
3	3,56
3"1/2	3,82
4	3,99
4"1/2	4,16
Tutto aperto	4,33

Aprendo il Bypass presente su ciascun modulo, è possibile avere un collettore che fa anche da separatore idraulico.

Soluzione molto comoda in presenza di più generatori di calore e/o circuiti primari.

VALVOLA DI BILANCIAMENTO

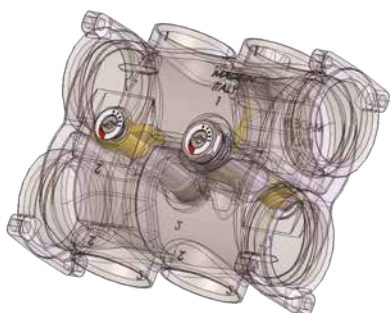

POSIZIONE INDICE ASTA	Kv
0	5,43
1	6,79
3	8,13
5	8,51
7	8,72

La regolazione della valvola di bilanciamento diventa estremamente comoda (in alcuni casi fondamentale) quando un collettore serve molti gruppi.

Infatti i gruppi sono tutti collegati in parallelo. In presenza di un gruppo sfavorito, le valvole di bilanciamento permettono di correggere la situazione bilanciando i circuiti e avendo così la certezza del corretto funzionamento dell'impianto.

ATTENZIONE

Ogni modulo del collettore ha 2 valvole di bilanciamento. Le valvole possono essere regolate da entrambi i lati del collettore.

Ogni valvola regola il Kv di una coppia di attacchi da G 1"1/4. Le valvole e gli attacchi corrispondenti sono controassegnati con un numero identificativo "1" e "2".

DISEGNO DIMENSIONALE COLLETTORE MODULARE

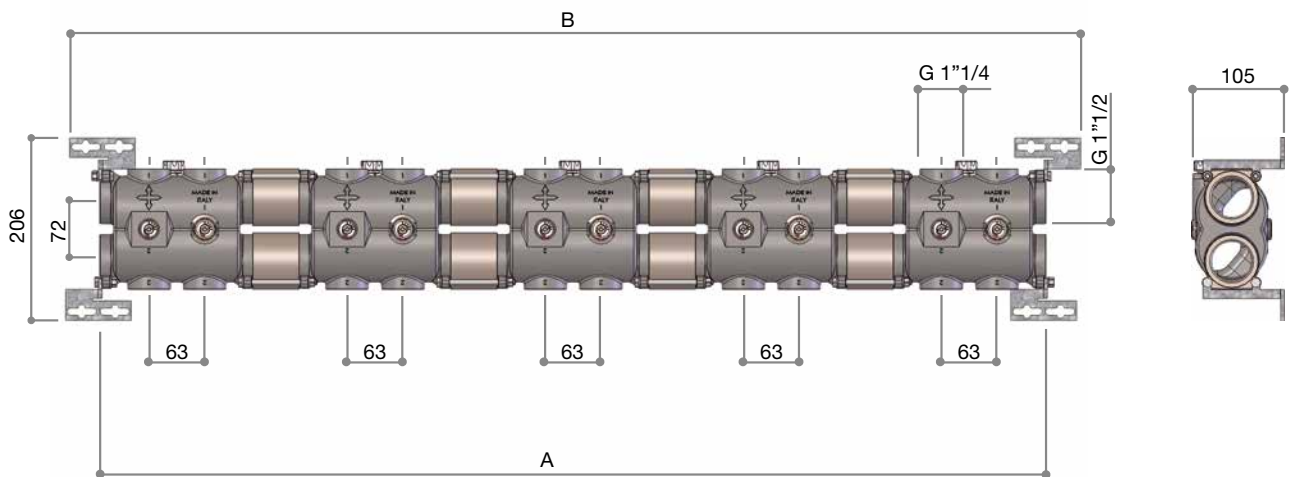

CD 1210

CODICE	N. ATTACCHI	A	B	C	D	E	F	G	H	L	M	N	P	R
68744251	1+1	174	267	-	-	-	-	-	-	-	-	-	-	-
68744252	2+2	398	471	-	-	-	-	-	-	-	-	-	-	-
68744253	3+3	622	695	-	-	-	-	-	-	-	-	-	-	-
68744254	4+4	846	919	-	-	-	-	-	-	-	-	-	-	-
68744255	5+5	1070	1143	-	-	-	-	-	-	-	-	-	-	-



CD 1210

Collettore modulare da G 1 1/2, con attacchi per i gruppi da G 1 1/4 e valvole di bypass e bilanciamento. Possibilità di aprire il bypass installato su tutti i moduli, in modo da funzionare anche come separatore idraulico. Passaggio interno libero \varnothing 45mm. (la versione CB è coibentata).

CODICE	N. ATTACCHI	MISURA			
68744251	1+1	G 1 1/2 x G 1 1/4	3,884	1	-
68744251CB	1+1		3,964	1	-
68744252	2+2		8,226	1	-
68744252CB	2+2		8,386	1	-
68744253	3+3		12,568	1	-
68744253CB	3+3		12,808	1	-
68744254	4+4		16,910	1	-
68744254CB	4+4		17,230	1	-
68744255	5+5		21,252	1	-
68744255CB	5+5		21,652	1	-

GRUPPO DI RILANCIO

DISEGNO DIMENSIONALE

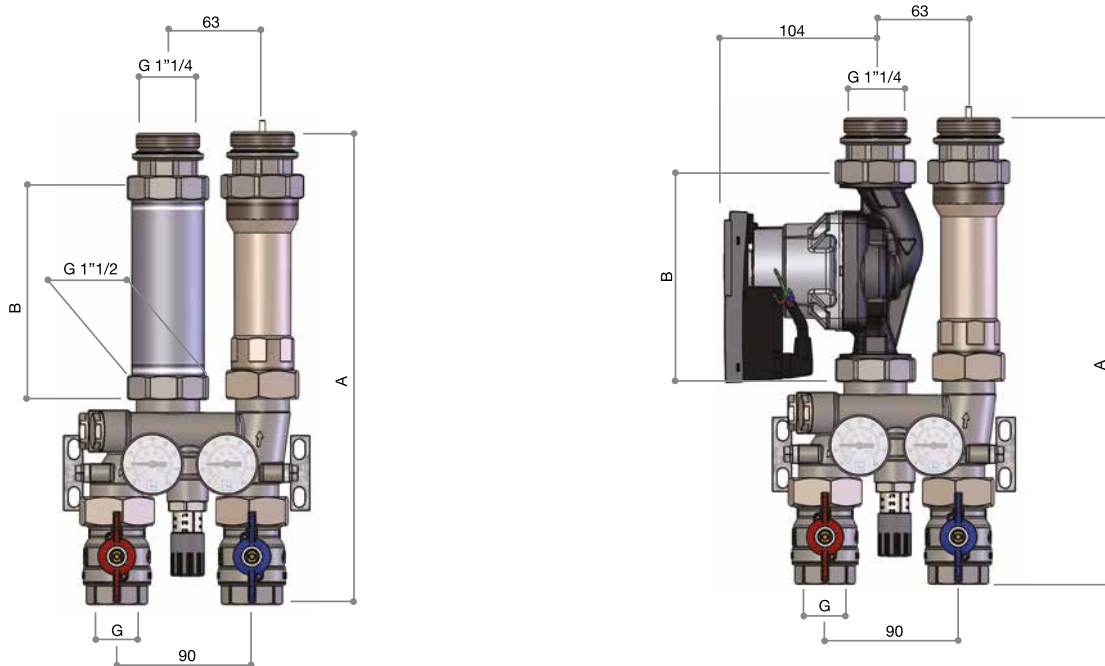

GR 1220

CODICE	MISURA	A	B	C	D	E	F	G
68763400	G 1"	315	130	-	-	-	-	G 1"
68764200	G 1"1/4	415	180	-	-	-	-	G 1"1/4

GR 1230

CODICE	MISURA	A	B	C	D	E	F	G
68763410	G 1"	315	130	-	-	-	-	G 1"
68764210	G 1"1/4	415	180	-	-	-	-	G 1"1/4

SCHEMA IDRAULICO

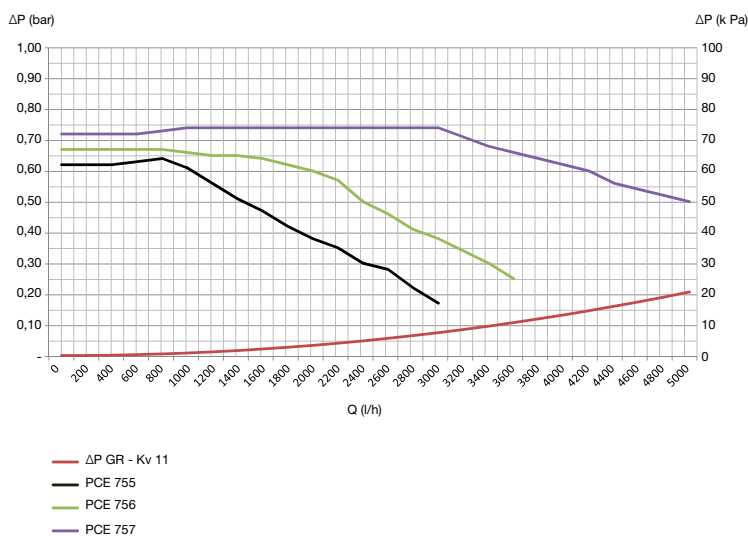
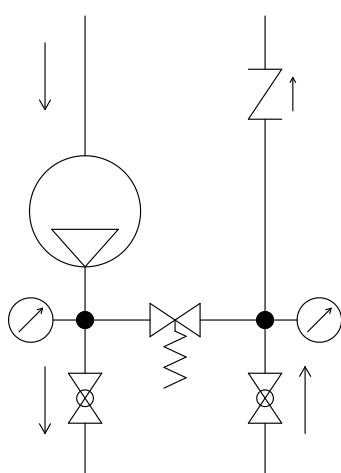

Per evitare eccessive rumorosità dell'impianto, evitare l'impiego con valori di ΔP superiori a 0,2-0,25 bar.

GRUPPO DI RILANCIO

**GR 1220**

Gruppo di rilancio senza pompa.
Portata massima consigliata 3.000 l/h.

Ogni gruppo è provvisto di:

- termometri per la visualizzazione delle temperature di mandata e ritorno;
- valvola di Bypass differenziale;
- valvola unidirezionale;
- valvole a sfera per l'intercettazione dei circuiti.

(la versione CB è coibentata).

CODICE	MISURA	INTERASSE			
68763400	G 1"	130 mm	4,474	1	-
68763400CB	G 1"	130 mm	4,754	1	-
68764201	G 1"	180 mm	4,922	1	-
68764200	G 1"1/4	180 mm	5,474	1	-
68764200CB	G 1"1/4	180 mm	5,754	1	-

**GR 1230**

Gruppo di rilancio con pompa.
Portata massima consigliata 3.000 l/h.

Ogni gruppo è provvisto di:

- termometri per la visualizzazione delle temperature di mandata e ritorno;
- valvola di bypass differenziale;
- valvola unidirezionale;
- valvole a sfera per l'intercettazione dei circuiti.

(la versione CB è coibentata).

CODICE	MISURA	INTERASSE			
68763410	G 1"	130 mm	5,582	1	-
68763410CB	G 1"	130 mm	5,862	1	-
68764210	G 1"1/4	180 mm	8,092	1	-
68764210CB	G 1"1/4	180 mm	8,372	1	-

GRUPPO A PUNTO FISSO

DISEGNO DIMENSIONALE

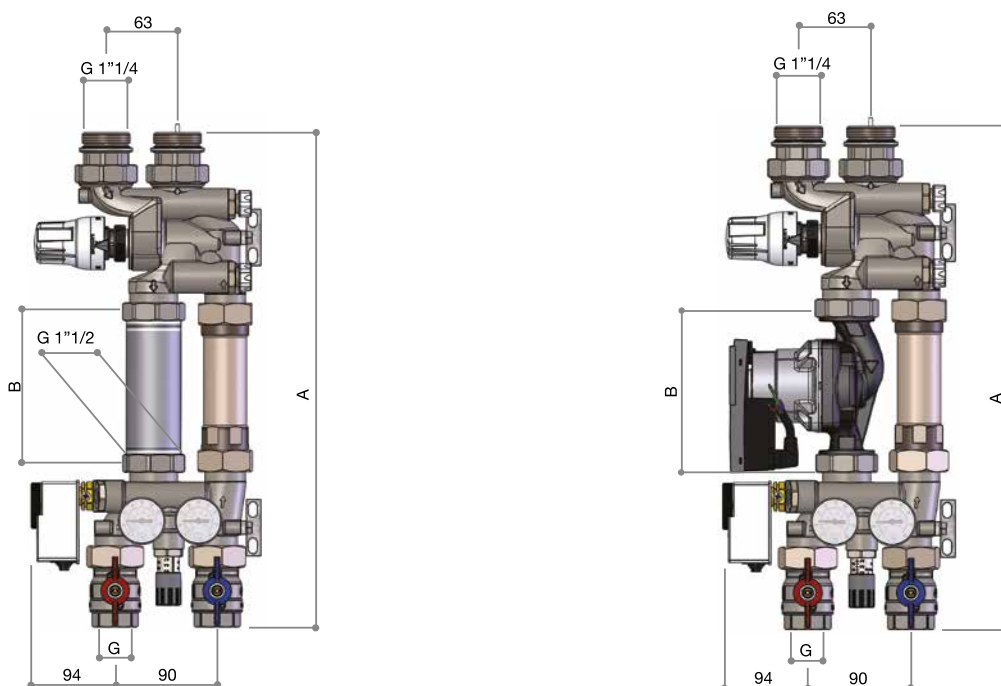

GM 1240

CODICE	MISURA	A	B	C	D	E	F	G
68763420	G 1"	437	130	-	-	-	-	G 1"
68764220	G 1 1/4"	537	180	-	-	-	-	G 1 1/4"

GM 1250

CODICE	MISURA	A	B	C	D	E	F	G
68763430	G 1"	437	130	-	-	-	-	G 1"
68764230	G 1 1/4"	537	180	-	-	-	-	G 1 1/4"

SCHEMA IDRAULICO

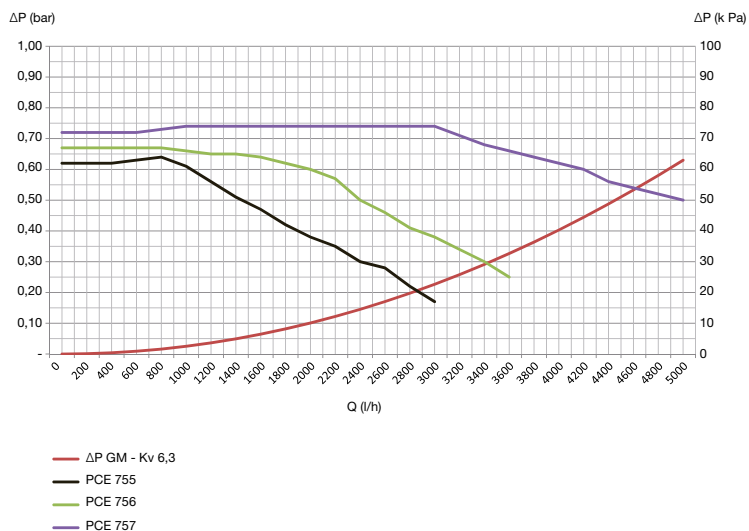
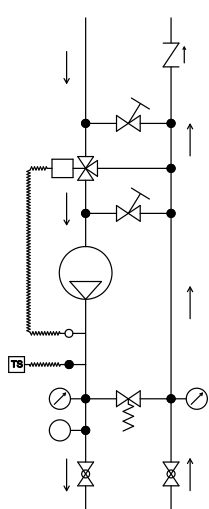

Per evitare eccessive rumorosità dell'impianto, evitare l'impiego con valori di ΔP superiori a 0,2-0,25 bar.

GRUPPO A PUNTO FISSO

**GM 1240**

Gruppo a punto fisso senza pompa.
Portata massima consigliata 2.750 l/h.
Ogni gruppo è provvisto di:

- valvola miscelatrice a pistone a 3 vie;
- testa termostatica di regolazione per punto fisso;
- valvole di bypass con regolazione manuale per i circuiti prima e dopo la miscelatrice;
- termometri per la visualizzazione delle temperature di mandata e ritorno;
- valvola di bypass differenziale;
- valvola unidirezionale;
- valvole a sfera per l'intercettazione dei circuiti.

(la versione CB è coibentata).

CODICE	MISURA	INTERASSE			
68763420	G 1"	130 mm	4,946	1	-
68763420CB	G 1"	130 mm	5,226	1	-
68764220	G 1"1/4	180 mm	5,827	1	-
68764220CB	G 1"1/4	180 mm	6,107	1	-

**GM 1250**

Gruppo a punto fisso con pompa.
Portata massima consigliata 2.750 l/h.
Ogni gruppo è provvisto di:

- valvola miscelatrice a pistone a 3 vie;
- testa termostatica di regolazione per punto fisso;
- valvole di bypass con regolazione manuale per i circuiti prima e dopo la miscelatrice;
- termometri per la visualizzazione delle temperature di mandata e ritorno;
- valvola di bypass differenziale;
- valvola unidirezionale;
- valvole a sfera per l'intercettazione dei circuiti.

(la versione CB è coibentata).

CODICE	MISURA	INTERASSE			
68763430	G 1"	130 mm	6,054	1	-
68763430CB	G 1"	130 mm	6,334	1	-
68764230	G 1"1/4	180 mm	8,445	1	-
68764230CB	G 1"1/4	180 mm	8,725	1	-

GRUPPO A PUNTO SCORREVOLE

DISEGNO DIMENSIONALE

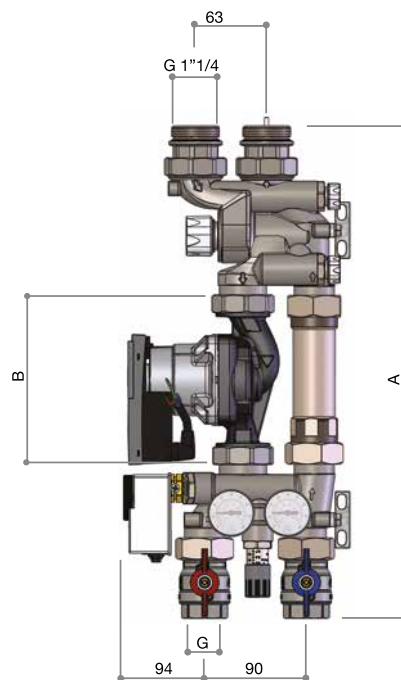
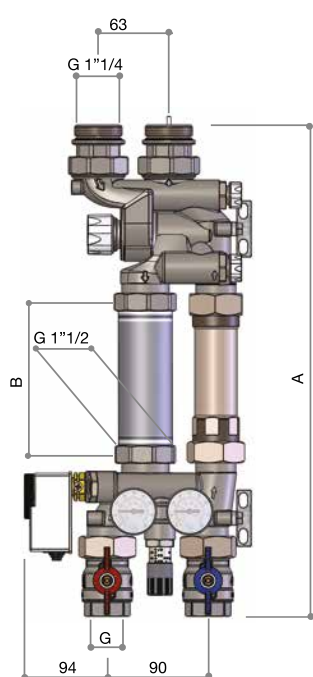

GM 1260

CODICE	MISURA	A	B	C	D	E	F	G
68763440	G 1"	437	130	-	-	-	-	G 1"
68764240	G 1 1/4"	537	180	-	-	-	-	G 1 1/4"

GM 1270

CODICE	MISURA	A	B	C	D	E	F	G
68763450	G 1"	437	130	-	-	-	-	G 1"
68764250	G 1 1/4"	537	180	-	-	-	-	G 1 1/4"

SCHEMA IDRAULICO

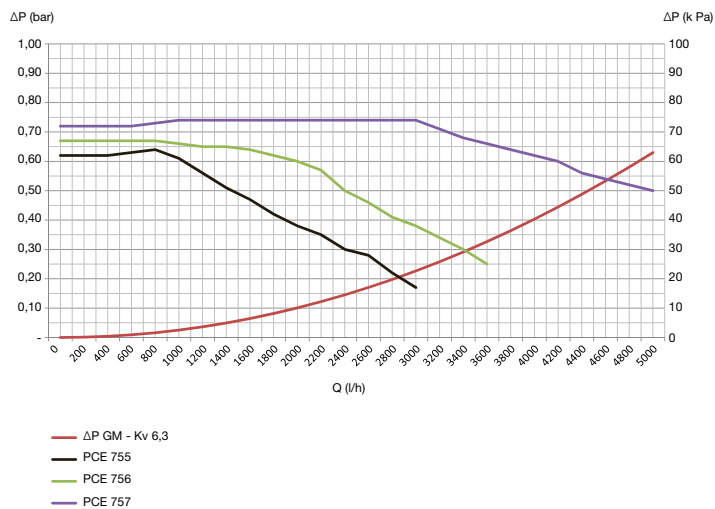
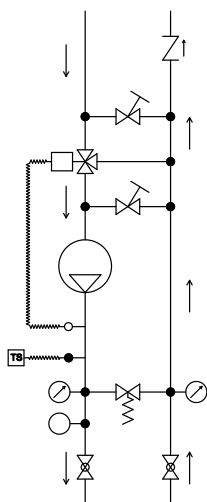

Per evitare eccessive rumorosità dell'impianto, evitare l'impiego con valori di ΔP superiori a 0,2-0,25 bar.

GRUPPO A PUNTO SCORREVOLE

**GM 1260**

Gruppo a punto scorrevole senza pompa.
Portata massima consigliata 2.750 l/h.

Ogni gruppo è provvisto di:

- valvola miscelatrice a pistone a 3 vie;
- possibilità di installare un motore 3 punti oppure 0-10 V, su un vitone con attacco standard M30x1,5 mm;
- valvole di bypass con regolazione manuale per i circuiti prima e dopo la miscelatrice;
- termometri per la visualizzazione delle temperature di mandata e ritorno;
- valvola di bypass differenziale;
- valvola unidirezionale;
- valvole a sfera per l'intercettazione dei circuiti.

(la versione CB è coibentata).

CODICE	MISURA	INTERASSE			
68763440	G 1"	130 mm	4,800	1	-
68763440CB	G 1"	130 mm	5,080	1	-
68764241	G 1"	180 mm	5,129	1	-
68764240	G 1"1/4	180 mm	5,681	1	-
68764240CB	G 1"1/4	180 mm	5,961	1	-

**GM 1270**

Gruppo a punto scorrevole con pompa.
Portata massima consigliata 2.750 l/h.

Ogni gruppo è provvisto di:

- valvola miscelatrice a pistone a 3 vie;
- possibilità di installare un motore 3 punti oppure 0-10 V, su un vitone con attacco standard M30x1,5 mm;
- valvole di bypass con regolazione manuale per i circuiti prima e dopo la miscelatrice;
- termometri per la visualizzazione delle temperature di mandata e ritorno;
- valvola di bypass differenziale;
- valvola unidirezionale;
- valvole a sfera per l'intercettazione dei circuiti.

(la versione CB è coibentata).

CODICE	MISURA	INTERASSE			
68763450	G 1"	130 mm	5,908	1	-
68763450CB	G 1"	130 mm	6,188	1	-
68764250	G 1"1/4	180 mm	8,299	1	-
68764250CB	G 1"1/4	180 mm	8,579	1	-

POSSIBILI APPLICAZIONI E ASSEMBLAGGI

GR 1220 - GR 1230

Utilizzabile per il collegamento ad una fonte di calore esterna oppure come gruppo di rilancio.

GM 1260 - GM 1270

Utilizzabile per impianti di riscaldamento a punto scorrevole.

GM 1260 - GM 1270

Utilizzabile per impianti di riscaldamento a punto scorrevole.

Il collettore può essere collegato al circuito primario sia attraverso gli attacchi laterali da G 1"1/2 sia attraverso gli attacchi superiori e inferiori da G 1"1/4.

Il collettore può essere collegato al circuito primario sia attraverso gli attacchi laterali da G 1"1/2 sia attraverso gli attacchi superiori e inferiori da G 1"1/4.

GR 1220 - GR 1230

Utilizzabile per il collegamento ad una fonte di calore esterna oppure come gruppo di rilancio.

GM 1260 - GM 1270

Utilizzabile per impianti di riscaldamento a punto scorrevole.

Collegando i moduli del collettore in modo opportuno tra loro, è possibile invertire la posizione degli attacchi alle colonne dei gruppi di rilancio e di miscelazione.

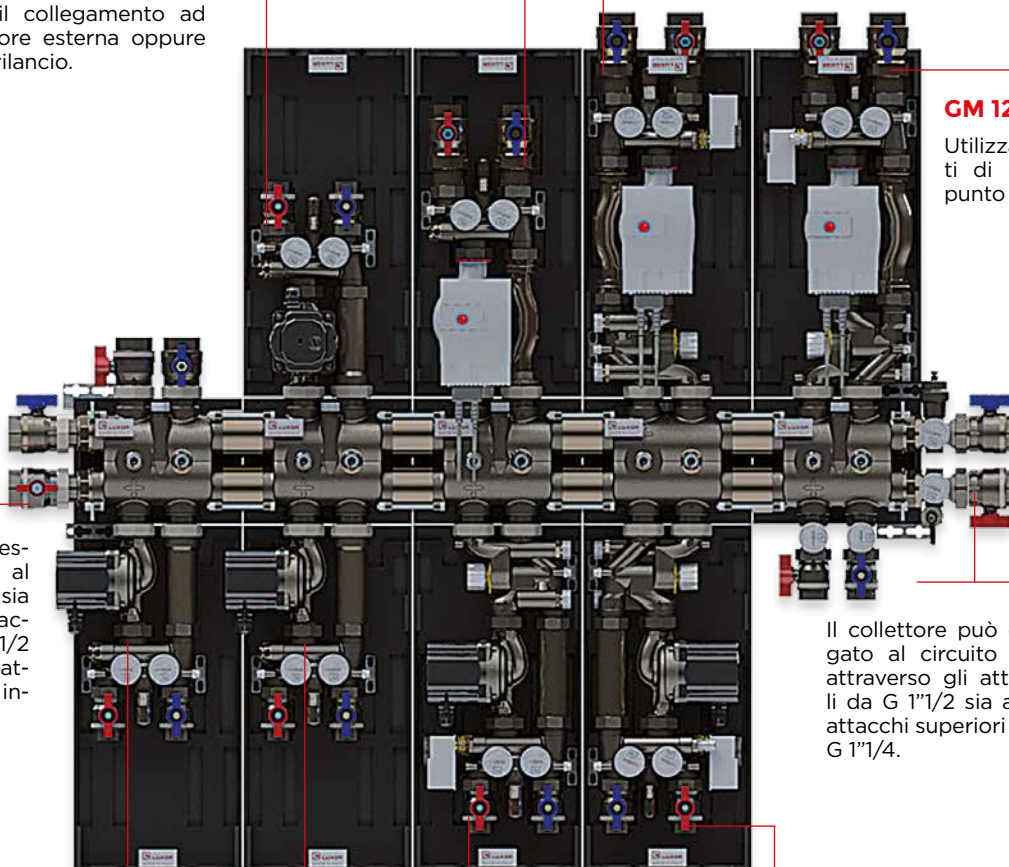

VALVOLA MISCELATRICE VM 1200



Valvola miscelatrice DN 25. Può essere abbinata alla testa termostatica per impianti a punto fisso TT 3051, oppure ad un attuatore che abbia il filetto M30x1,5, con punto di chiusura 11,5 mm e corsa ≥ 3 mm.

Sulla miscelatrice sono installati 2 bypass:

- **Bypass primario.** Consente di creare un ricircolo per la pompa del primario (es. pompa caldaia).
- **Bypass secondario.** Consente di creare un ricircolo per la pompa installata sul gruppo, permettendo di bilanciare la temperatura dei pannelli e creare inerzia termica per il sistema di regolazione della temperatura.

Attacchi al circuito primario da G 1"1/2 maschio.

Attacco alla pompa con dado girevole G 1"1/2 e attacco al tronchetto di ricircolo con dado girevole G 1"1/4.

CARATTERISTICHE TECNICHE

Kvs miscelatrice 5,5 (ricircolo) 6,9 (scambio primario)

Portata massima consigliata sulla miscelatrice 2.750 l/h (Δp 0,25bar - ricircolo)

Massima pressione differenziale consigliata sulla miscelatrice 0,25 bar

CARATTERISTICHE IDRAULICHE

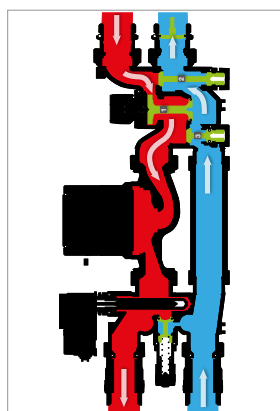

- 1 Miscelatrice tutta aperta
- 2 Bypass primario chiuso
- 3 Bypass secondario chiuso

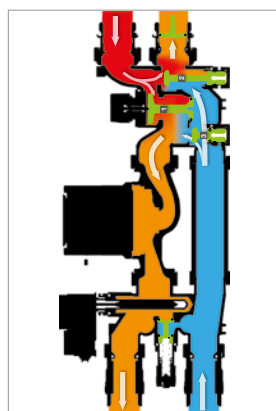

- 1 Miscelatrice tutta aperta
- 2 Bypass primario aperto
- 3 Bypass secondario aperto

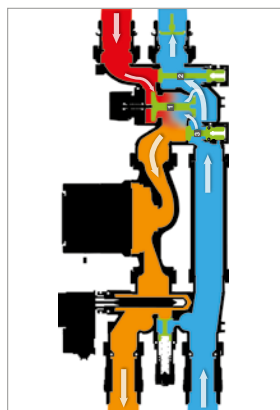

- 1 Miscelatrice parzialmente aperta
- 2 Bypass primario chiuso
- 3 Bypass secondario chiuso



- 1 Miscelatrice parzialmente aperta
- 2 Bypass primario aperto
- 3 Bypass secondario aperto

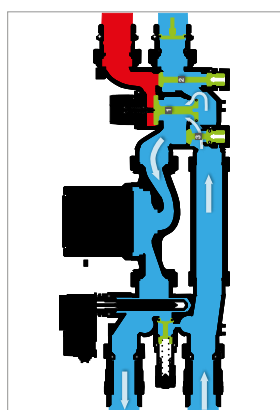

- 1 Miscelatrice chiusa
- 2 Bypass primario chiuso
- 3 Bypass secondario chiuso

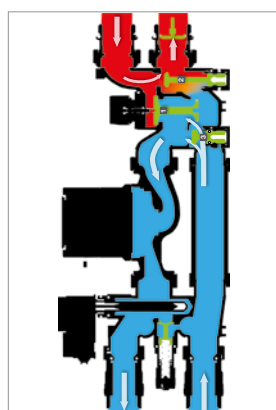

- 1 Miscelatrice chiusa
- 2 Bypass primario aperto
- 3 Bypass secondario aperto

DIAGRAMMA CARATTERISTICO IN FUNZIONE DELLA CORSA DEL VITONE

DIAGRAMMA PRIMARIO/RICIRCOLO CON BYPASS CHIUSO

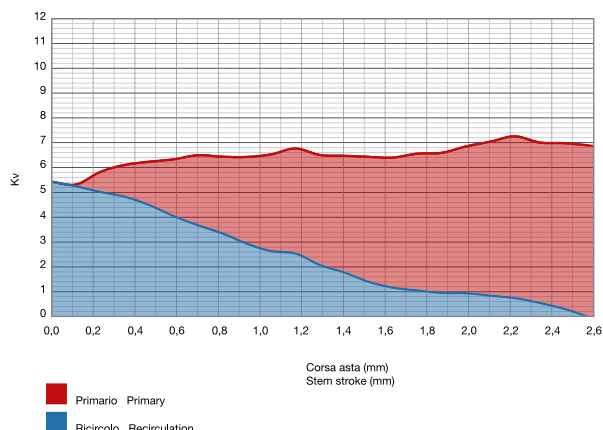

Kv PRIMARIO	Kv RICIRCOLO	CORSA ASTA	% PRIMARIO	% RICIRCOLO
0,00	5,43	chiuso	0%	100%
0,07	5,25	0,1	1%	99%
0,80	5,02	0,2	14%	86%
1,27	4,83	0,4	21%	79%
1,74	4,49	0,5	28%	72%
2,28	4,05	0,6	36%	64%
2,82	3,68	0,7	43%	57%
3,09	3,35	0,8	48%	52%
3,49	2,94	0,9	54%	46%
3,89	2,64	1,1	60%	40%
4,23	2,54	1,2	62%	38%
4,43	2,08	1,3	68%	32%
4,70	1,78	1,4	73%	27%
5,03	1,40	1,5	78%	22%
5,23	1,17	1,6	82%	18%
5,50	1,06	1,8	84%	16%
5,63	0,96	1,9	85%	15%
5,90	0,95	2,0	86%	14%
6,20	0,85	2,1	88%	12%
6,51	0,75	2,2	90%	10%
6,45	0,56	2,3	92%	8%
6,66	0,32	2,5	95%	5%
6,90	0,00	tutto aperto	100%	0%

DIAGRAMMA PRIMARIO/RICIRCOLO CON BYPASS APERTO

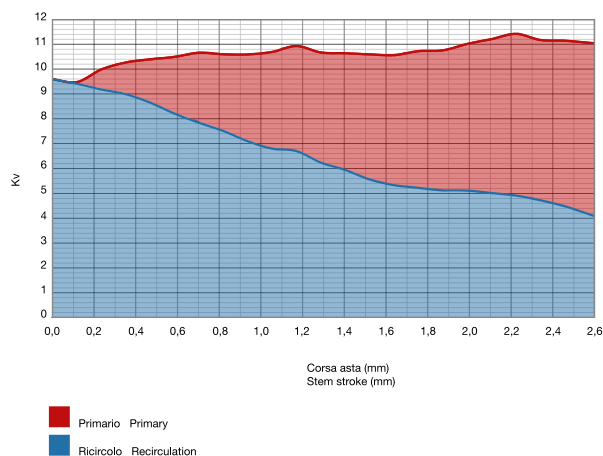

Kv PRIMARIO	Kv RICIRCOLO	CORSA ASTA	% PRIMARIO	% RICIRCOLO
0,00	9,59	chiuso	0%	100%
0,07	9,41	0,1	1%	99%
0,80	9,18	0,2	8%	92%
1,27	8,99	0,4	12%	88%
1,74	8,65	0,5	17%	83%
2,28	8,21	0,6	22%	78%
2,82	7,84	0,7	26%	74%
3,09	7,51	0,8	29%	71%
3,49	7,10	0,9	33%	67%
3,89	6,80	1,1	36%	64%
4,23	6,70	1,2	39%	61%
4,43	6,24	1,3	42%	58%
4,70	5,94	1,4	44%	56%
5,03	5,56	1,5	48%	52%
5,23	5,33	1,6	50%	50%
5,50	5,22	1,8	51%	49%
5,63	5,12	1,9	52%	48%
5,90	5,11	2,0	54%	46%
6,20	5,01	2,1	55%	45%
6,51	4,91	2,2	57%	43%
6,45	4,72	2,3	58%	42%
6,66	4,48	2,5	60%	40%
6,90	4,16	tutto aperto	62%	38%

PROSPETTO VALORI KV BYPASS MISCELATRICE IN FUNZIONE DEL NUMERO DI GIRI DELL'OTTURATORE

BYPASS PRIMARIO		BYPASS SECONDARIO	
N. GIRI DALLA CHIUSURA	Kv	N. GIRI DALLA CHIUSURA	Kv
1/4	0,30	1/4	0,25
1/2	0,64	1/2	0,59
1	1,32	1	1,27
1 1/2	2,04	1 1/2	1,87
2	2,72	2	2,38
2 1/2	3,48	2 1/2	2,97
3	4,07	3	3,22
3 1/2	4,33	3 1/2	3,56
4	4,58	4	3,73
4 1/2	4,67	4 1/2	3,82
tutto aperto	4,67	tutto aperto	4,16

ACCESSORI COLLETTORI DI DISTRIBUZIONE

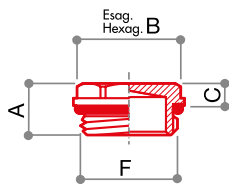

TC 460

Tappo cieco con guarnizione o-ring.

CODICE	MISURA	FINITURA	A	B	C	D	E	F	G	H	L			
68559942N	G 1" 1/4	NICHELATA	25	38	12	-	-	G 1" 1/4	-	-	-	94	30	240
68559948N	G 1" 1/2	NICHELATA	26	48	16	-	-	G 1" 1/2	-	-	-	160	16	128

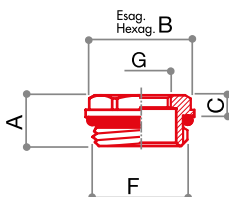

TC 462

Tappo con riduzione e con guarnizione di tenuta o-ring.

CODICE	MISURA	FINITURA	A	B	C	D	E	F	G	H	L			
68559916N	G 1" 1/2 x G 1"	NICHELATA	26	48	16	-	-	G 1" 1/2	G 1"	-	-	200	16	128
68559915N	G 1" 1/2 x G 1" 1/4	NICHELATA	26	48	16	-	-	G 1" 1/2	G 1" 1/4	-	-	124	16	128

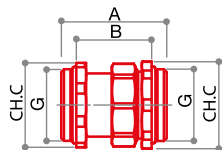

RD 455

Raccordo di unione M-M in tre pezzi con guarnizione o-ring.

CODICE	MISURA	A	B	C	D	E	F	G	H	L			
68994801N	G 1" 1/2	70	50	65	-	-	-	G 1" 1/2	-	-	460	5	40

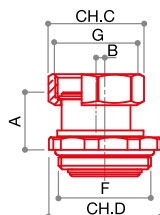

RE 447

Raccordo eccentrico per l'assemblaggio dei gruppi sul collettore CD1210 sul lato attacco caldaia. Da utilizzare in coppia.

CODICE	MISURA	A	B	C	D	E	F	G	H	L			
68994810N	G 1" 1/2 M x G 1" 1/4 F	30	4,5	46	56	-	G 1" 1/2	G 1" 1/4	-	-	340	5	40

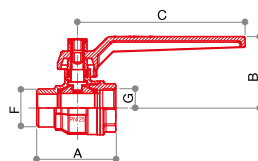

VC 476

Valvola a sfera a passaggio totale, nichelata, senza bocchettone, con leva di colore blu o rossa.

CODICE	MISURA	A	B	C	D	E	F	G	H	L			
68559829B	G 1"1/2	91	75	150	-	-	G 1"1/2	G 1"1/2	-	-	1400	2	16
68559829R	G 1"1/2	91	75	150	-	-	G 1"1/2	G 1"1/2	-	-	1400	2	16

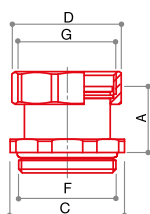

CR 496

Dado e raccordo nichelato con guarnizione per il collegamento della valvola a sfera VC476.

CODICE	MISURA	A	B	C	D	E	F	G	H	L			
67934800	G 1"1/2	32	-	56	52	-	G 1"1/2	G 1"1/2	-	-	280	6	48

COIBENTAZIONE

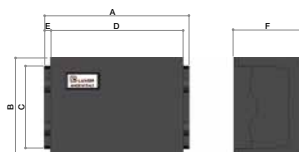

CB 1220

Coibentazione per modulo collettore CD 1210.

CODICE	MISURA	A	B	C	D	E	F	G	H	L			
72000080	G 1"1/4 x G 1"	243	166	138	223	10	135	-	-	-	80	-	1

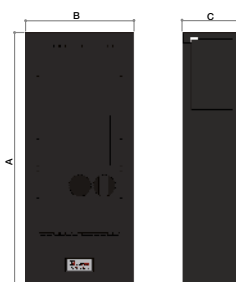

CB 1222

Coibentazione per i gruppi di rilancio e miscelazione.

CODICE	MISURA	A	B	C	D	E	F	G	H	L			
Gruppi di rilancio													
72000082	G 1" - 130 mm	520	223	135	-	-	-	-	-	-	280	-	1
72000084	G 1"1/4 - 180 mm	520	223	135	-	-	-	-	-	-	280	-	1
Gruppi di miscelazione													
72000086	G 1" - 130 mm	520	223	135	-	-	-	-	-	-	280	-	1
72000088	G 1"1/4 - 180 mm	520	223	135	-	-	-	-	-	-	280	-	1



7 / RACCORDI

RACCORDI

RACCORDI A STRINGERE PER TUBI RAME, PLASTICA E MULTISTRATO



CARATTERISTICHE TECNICHE



Max temperatura

120 °C



Max pressione

10 bar



Dadi

CW617N
UNI EN
12165:2016

Raccordi

CW614N
UNI EN
12164:2016

Guarnizioni OR

EPDM



Guarnizioni

Polietilene

ATTACCHI IMPIANTO



Tubo ferro

W 24x19 - TR 91
G 3/4 EK - TR 91/A
G 1/2 - TR 890
G 1/2 - TR 94
G 1/2 - TR 92

Tubo rame

W 24x19 - TR 91
G 3/4 EK - TR 91/A
G 1/2 - TR 890
G 1/2 - TR 94
G 1/2 - TR 92

Tubo plastica

W 24x19 - TP 95
G 3/4 EK - TP 98
G 1/2 - TP 93

Tubo multistrato

W 24x19 - TP 97
G 3/4 EK - TP 99
G 1/2 - TP 96
G 1/2 F - TP 90

ISTRUZIONI OPERATIVE

Per evitare inconvenienti derivanti da un montaggio non corretto, i quali potrebbero risultare molto onerosi, si consiglia di seguire queste brevi istruzioni:

• Preparazione del tubo.

1. **Taglio del tubo.** Per eseguire un taglio corretto, utilizzare le cesoie apposite in modo da non ovalizzare il tubo e facendo particolare attenzione che il taglio sia perpendicolare all'asse del tubo.

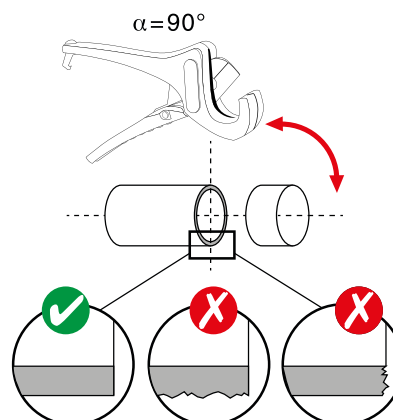

Le caratteristiche del fluido dell'impianto devono essere conformi alla direttiva UNI 8065:2019.

2. Calibratura. Questa operazione consente di ottenere il diametro interno corretto.

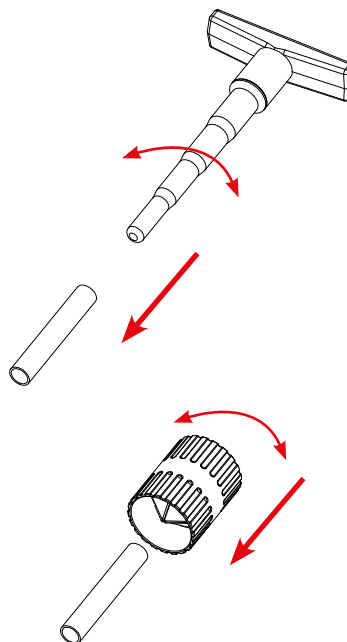

3. Svasatura. L'operazione di svasatura crea uno smusso interno che facilita l'inserimento dei raccordi nel tubo ed evita che gli o-rings possano fuoriuscire dalle loro sedi.

CORRETTO ASSEMBLAGGIO DEL RACCORDO A STRINGERE

Montare gli elementi che compongono il raccordo nell'ordine e verso indicato nelle figure.

RACCORDI PER TUBO RAME/ACCIAIO DOLCE			RACCORDI PER TUBO PLASTICA	RACCORDI PER TUBO MULTISTRATO
TR 91 • TR 91/A	TR 92	TR 94	TP 93 • TP 95 • TP 98	TP 96 • TP 97 • TP 99
↓	↓	↓	↓	↓

Inserire il tubo con relativo portagomma nella tasca del raccordo avendo cura che la stessa sia pulita ed evitando di pizzicare l'o-ring di tenuta.

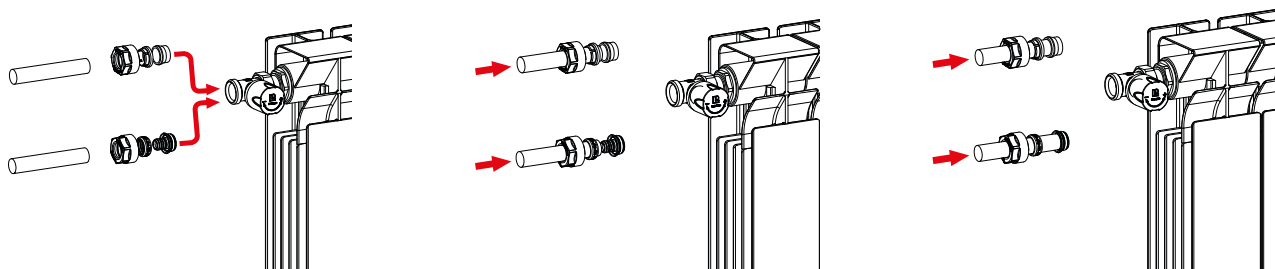

È assolutamente vietato lubrificare le parti in gomma con oli o grassi a base minerale: la miscela EPDM è compatibile solo con lubrificanti a base siliconica. Per evitare qualsiasi equivoco, si consiglia di lubrificare le parti in gomma semplicemente con acqua.

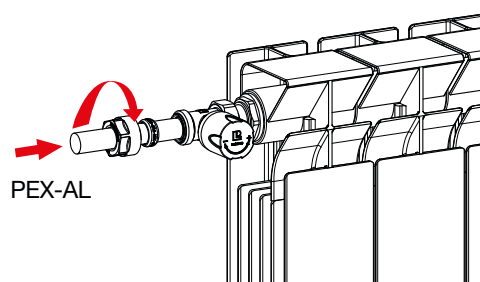
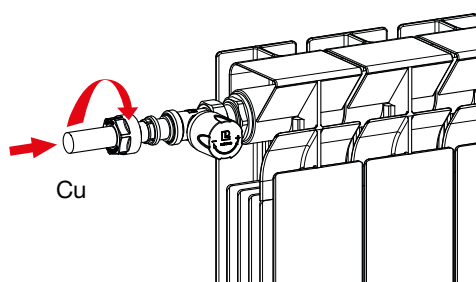
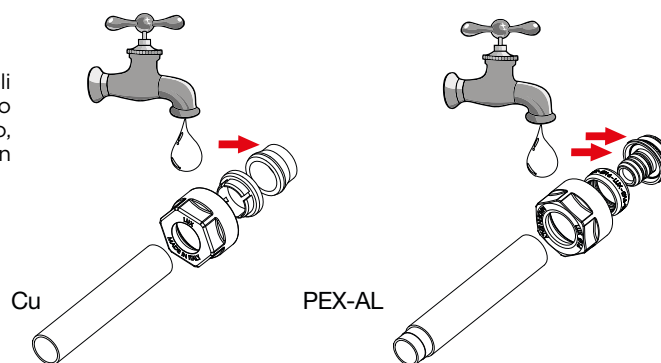

Imboccare il dado ed avvitarlo a mano fino a quando è possibile e quindi a fondo con l'apposita chiave art. CH 110.

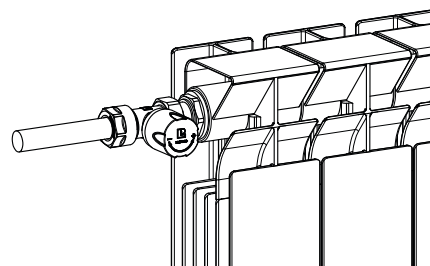
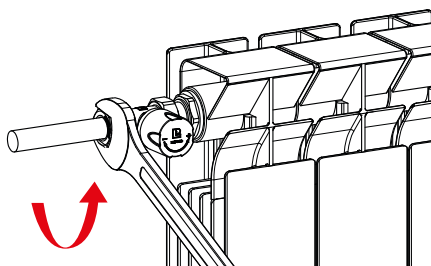

COPPIE DI SERRAGGIO

Per un uso corretto della raccorderia è indispensabile seguire la tabella sotto indicata, riguardante le coppie di serraggio dei dadi a seconda della tipologia di raccordo e della natura del tubo.



MISURA TUBO	RAME RICOTTO	RAME SEMIDURO	ACCIAIO DOLCE	POLIETILENE POLIPROPILENE POLIBUTENE	MULTISTRATO PEX-AL-PEX
Fino a Ø 18 mm	Da 35 a 45 Nm	Da 60 a 80 Nm	Da 60 a 70 Nm	Da 40 a 50 Nm	Da 25 a 35 Nm
Oltre Ø 18 mm	-	-	-	Da 40 a 50 Nm	Da 25 a 35 Nm

RACCORDI PER TUBO RAME



TR 92

Raccordo a compressione con ogiva in ottone per tubo rame o acciaio morbido. Conforme secondo il D.M. 174/2004.

CODICE	MISURA			
67611400	14 mm	24	100	800
67611500	15 mm	21	100	800

filetto G1/2



TR 94

Raccordo a compressione con ogiva in ottone a tenuta o-ring per tubo rame o acciaio morbido per raccordi sottotraccia G1/2.

CODICE	MISURA			
67621500	15 mm	20	100	800

filetto G1/2



TR 890

Raccordo a compressione morbida con ogiva in PTFE/CV - per tubo rame - filetto da G1/2.

CODICE	MISURA			
68720010	10 mm	26	50	400
68720012	12 mm	25	50	400
68720014	14 mm	20	50	400
68720016	16 mm	19	50	400

filetto G1/2



TR 91

Raccordo a compressione morbida con ogiva in EPDM - per tubo rame - filetto da W24x19.

CODICE	MISURA			
67760010	10 mm	52	50	400
67760012	12 mm	44	50	400
67760014	14 mm	42	50	400
67760015	15 mm	40	50	400
67760016	16 mm	38	50	400
67760018	18 mm	36	50	400

filetto W24x19



TR 91/A

Raccordo a compressione morbida con ogiva in EPDM - per tubo rame - filetto da G3/4 eurocono.

CODICE	MISURA			
67761000	10 mm	54	40	320
67761200	12 mm	52	40	320
67761400	14 mm	50	40	320
67761500	15 mm	50	40	320
67761600	16 mm	48	40	320
67761800	18 mm	46	40	320

filetto G3/4 eurocono

RACCORDI PER TUBO IN POLIETILENE, POLIBUTENE E POLIPROPILENE

TP 93



Raccordo a compressione per tubo in polietilene, polibutene e polipropilene, filetto da G1/2.

CODICE	MISURA			
67801208	12 x 2	56	50	400
67801510	15 x 2,5	48	50	400
67801612	16 x 2	45	50	400
67801616	16 x 2,2	44	50	400

filetto G1/2

TP 95

Raccordo a compressione per tubo in polietilene, polibutene e polipropilene, filetto da W24x19.

CODICE	MISURA			
67781008	10,5 x 1,25	62	50	400
67781210	12 x 1	52	50	400
67781209	12 x 1,5	60	50	400
67781208	12 x 2	59	50	400
67781410	14 x 2	60	50	400
67781511	15 x 2	54	50	400
67781510	15 x 2,5	56	50	400
67781613	16 x 1,5	52	50	400
67781612	16 x 2	56	50	400
67781616	16 x 2,2	56	50	400
67781611	16 x 2,5	56	50	400
67781628	16 x 2,8	56	50	400
67781713	17 x 2	50	50	400
67781814	18 x 2	48	50	400
67781813	18 x 2,5	48	50	400
67782016	20 x 2	60	50	400
67782017	20 x 2,8	68	50	400
67782034	20 x 3,4	60	50	400

filetto W24x19



TP 98

Raccordo a compressione per tubo in polietilene, polibutene e polipropilene, filetto G3/4 eurocono.

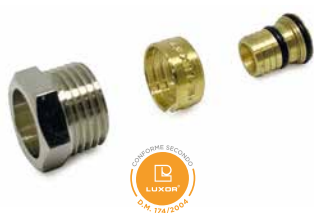

CODICE	MISURA			
67841007	10 x 1,2	76	40	320
67841209	12 x 1,5	76	40	320
67841208	12 x 2	76	40	320
67841410	14 x 2	70	40	320
67841510	15 x 2,5	70	40	320
67841613	16 x 1,5	60	40	320
67841618	16 x 1,8	60	40	320
67841612	16 x 2	60	40	320
67841616	16 x 2,2	68	40	320
67841713	17 x 2	58	40	320
67841814	18 x 2	68	40	320
67842016	20 x 2	57	40	320
67842028	20 x 2,8	64	40	320
67842034	20 x 3,4	60	40	320

filetto G3/4 eurocono

RACCORDI PER TUBO IN POLIETILENE MULTISTRATO PEX-AL-PEX

**TP 90**



Raccordo a compressione per tubo in polietilene multistrato PEX-AL-PEX per attacco tubo ferro G1/2.

CODICE	MISURA			
67631612	16 x 2	27	50	400

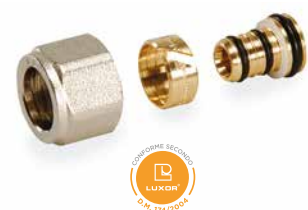
filetto G1/2

**TP 96**



Raccordo a compressione per tubo in polietilene multistrato PEX-AL-PEX filetto G1/2.

CODICE	MISURA			
67871410	14 x 2	56	50	400
67871612	16 x 2	57	50	400
67871611	16 x 2,25	52	50	400

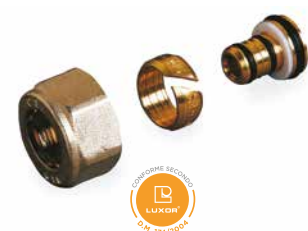
filetto G1/2

**TP 97**

Raccordo a compressione per tubo in polietilene multistrato PEX-AL-PEX filetto da W24x19.

CODICE	MISURA			
67821410	14 x 2	54	50	400
67821612	16 x 2	52	50	400
67821611	16 x 2,25	52	50	400
67821626	16,2 x 3	52	50	400
67821711	17 x 2,75	49	50	400
67821713	17 x 2	50	50	400
67821712	17 x 2,5	50	50	400
67821814	18 x 2	50	50	400
67822016	20 x 2	66	50	400
67822017	20 x 2,25	64	50	400
67822015	20 x 2,5	62	50	400
67822014	20 x 3	62	50	400

filetto W24x19

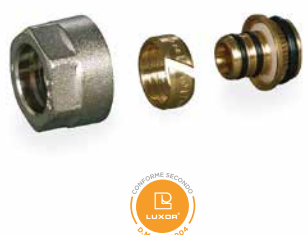
**TP 99**

Raccordo a compressione per tubo in polietilene multistrato PEX-AL-PEX filetto G3/4 eurocono.

CODICE	MISURA			
67861210	12,2 x 1,3	74	40	320
67861410	14 x 2	78	40	320
67861512	15 x 1,5	63	40	320
67861612	16 x 2	74	40	320
67861611	16 x 2,25	74	40	320
67861610	16,2 x 3	74	40	320
67861713	17 x 2	74	40	320
67861712	17 x 2,5	74	40	320
67861711	17 x 2,75	70	40	320
67861814	18 x 2	74	40	320
67862016	20 x 2	78	40	320
67862017	20 x 2,25	76	40	320
67862015	20 x 2,5	74	40	320
67862014	20 x 3	72	40	320

filetto G3/4 eurocono

RACCORDI A STRINGERE CROMATI PER TUBO RAME



TR 91/AC

Raccordo a compressione morbida con ogiva in EPDM - per tubo rame - filetto da G3/4 **eurocono**.

CODICE	MISURA			
67761000C	10 mm	57	20	240
67761200C	12 mm	54	20	240
67761400C	14 mm	51	20	240
67761500C	15 mm	48	20	240
67761600C	16 mm	46	20	240

filetto G3/4 eurocono

RACCORDI A STRINGERE CROMATI PER TUBO IN POLIETILENE, POLIBUTENE E POLIPROPILENE



TP 98/C

Raccordo a compressione per tubo in polietilene, polibutene e polipropilene, filetto da G3/4 **eurocono**.

CODICE	MISURA			
67841410C	14 x 2	65	20	240
67841612C	16 x 2	61	20	240
67841713C	17 x 2	58	20	240
67841814C	18 x 2	59	20	240
67842016C	20 x 2	57	20	240

filetto G3/4 eurocono

RACCORDI A STRINGERE CROMATI PER TUBO IN POLIETILENE MULTISTRATO PEX-AL-PEX



TP 99/C

Raccordo a compressione per tubo in polietilene multistrato PEX-AL-PEX, filetto da G3/4 **eurocono**.

CODICE	MISURA			
67861410C	14 x 2	67	20	240
67861612C	16 x 2	65	20	240
67861611C	16 x 2.25	60	20	240
67861713C	17 x 2	60	20	240
67861814C	18 x 2	61	20	240
67862016C	20 x 2	59	20	240

filetto G3/4 eurocono

RACCORDI SOTTOTRACCIA PER LA DISTRIBUZIONE CON TUBI SFILABILI

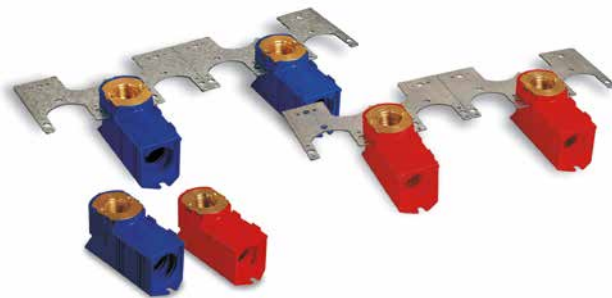

CARATTERISTICHE COSTRUTTIVE

I raccordi Luxor sono prodotti per soddisfare le moderne esigenze di utilizzo del tubo in plastica sfilabile per la distribuzione sanitaria e di riscaldamento.

I principali vantaggi di questo prodotto sono:

- facilità nella posa delle tubazioni;
- possibilità di manutenzione senza danneggiare le pareti, agendo all'interno delle scatole di plastica che isolano i raccordi dall'intonaco;
- bassa rumorosità del sistema grazie all'assenza di giunzioni che creano turbolenze;
- qualità estetica dell'impianto finito.

I raccordi sono prodotti in ottone resistente alla dezincificazione CW626N UNI EN 12165:2016.

Tutte le guarnizioni di tenuta sono in EPDM perossidico.

Le scatole in plastica che racchiudono i raccordi sono in polipropilene con carica di talco.

Utilizzando il tubo di raccordo in rame cromato articolo M 528, si avrà la tenuta garantita tramite un o-ring e una resa esteti-

CARATTERISTICHE TECNICHE



Max temperatura

120 °C



Max pressione

10 bar

ca assicurata da un tubo cromato di collegamento sempre in asse con il raccordo e la parete.

Le staffe articolo SS 1982 sono in ferro zincato FeZ100-EN10142-92 e sono frazionabili. Questi articoli permettono di posizionare con velocità e sicurezza i raccordi alle profondità volute rispetto all'intonaco e con gli interassi corretti per il collegamento agli apparecchi sanitari.

Tutti i raccordi con attacco per il collegamento al tubo di rame o plastica vengono forniti senza i relativi raccordi montati.



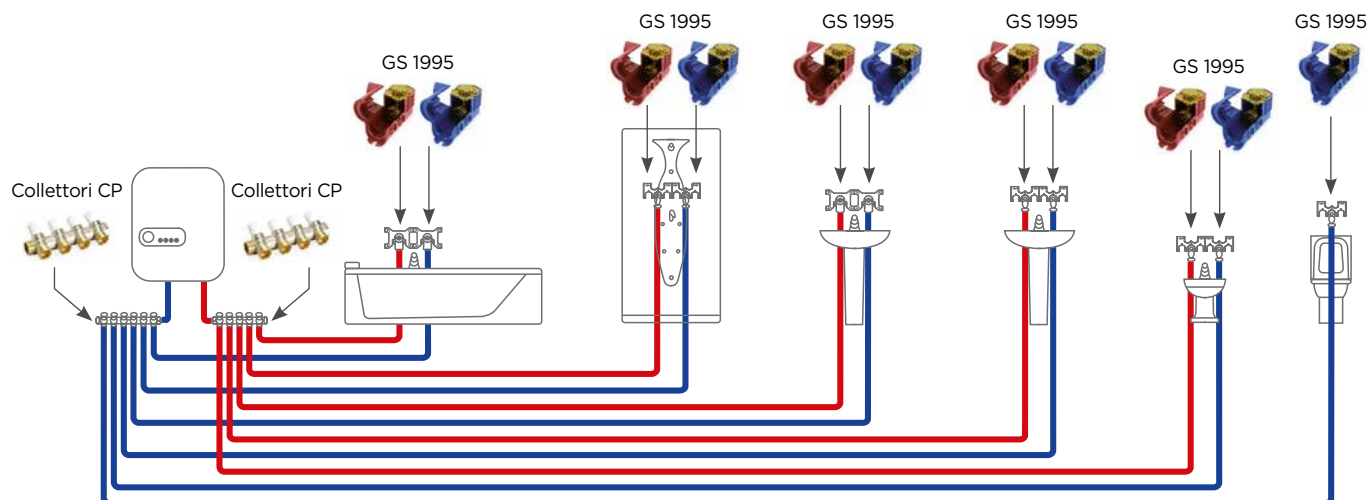

IMPIANTO PER LA DISTRIBUZIONE SANITARIA CON UNA MANDATA PER OGNI UTENZA

Questa tipologia di impianto è la più comune, prevede che ogni utenza sia collegata direttamente ad una uscita del collettore di distribuzione.

I **vantaggi** di questo tipo di impianti sono:

- pressione costante per ogni utenza;
- possibilità di regolare la portata per ogni singola utenza;
- facilità di manutenzione;

Gli **svantaggi** sono:

- elevata quantità di tubo utilizzata;
- cassette di distribuzione di grosse dimensioni.

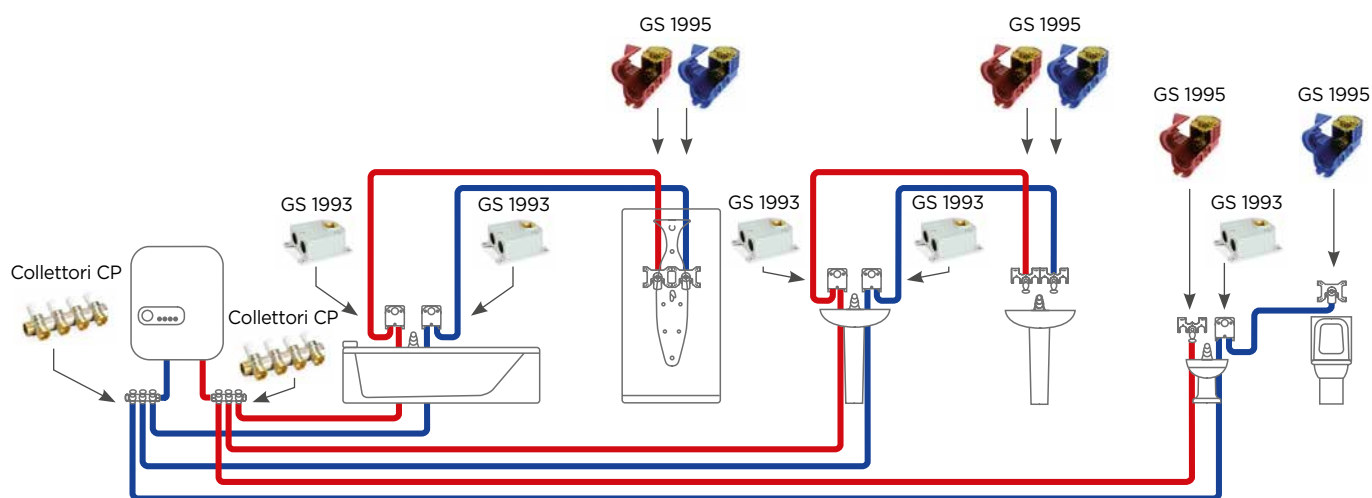

IMPIANTO PER LA DISTRIBUZIONE SANITARIA A BLOCCHI

Questa tipologia di impianto prevede di dividere le utenze per gruppi.

I **vantaggi** di questo tipo di impianti sono:

- ridotto costo di realizzazione;
- minore ingombro occupato dai tubi e dalla cassetta di distribuzione.

Gli **svantaggi** sono:

- nel caso di uso contemporaneo di più utenze, il flusso d'acqua è ripartito tra i vari utilizzatori.

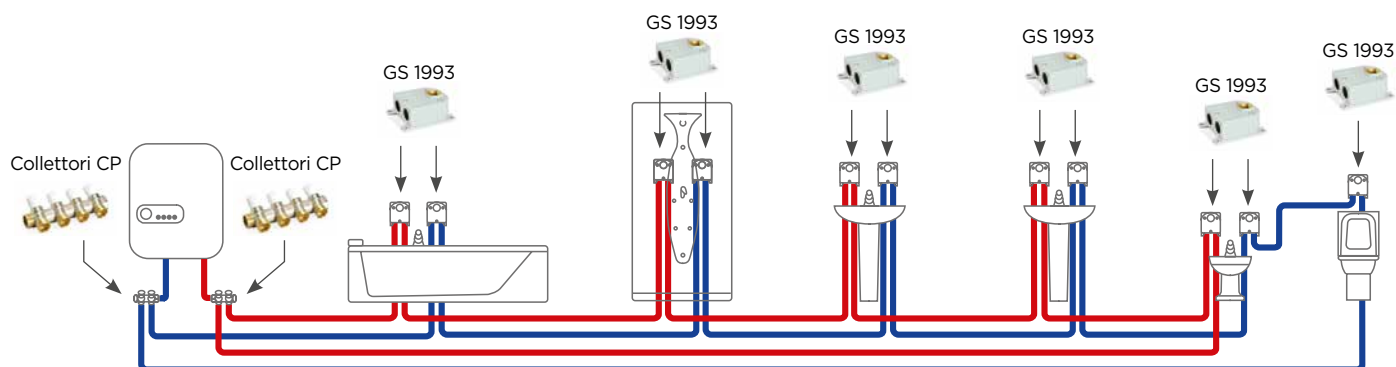

IMPIANTO MOTUBO PER LA DISTRIBUZIONE SANITARIA

Questa tipologia è la più semplice.

I **vantaggi** di questo tipo di impianti sono:

- semplicità di realizzazione;
- minimo ingombro di tubi e cassetta di distribuzione;
- ridotto costo di realizzo.

Gli **svantaggi** sono:

- nel caso di uso contemporaneo di più utenze, il flusso d'acqua è ripartito tra i vari utilizzatori.

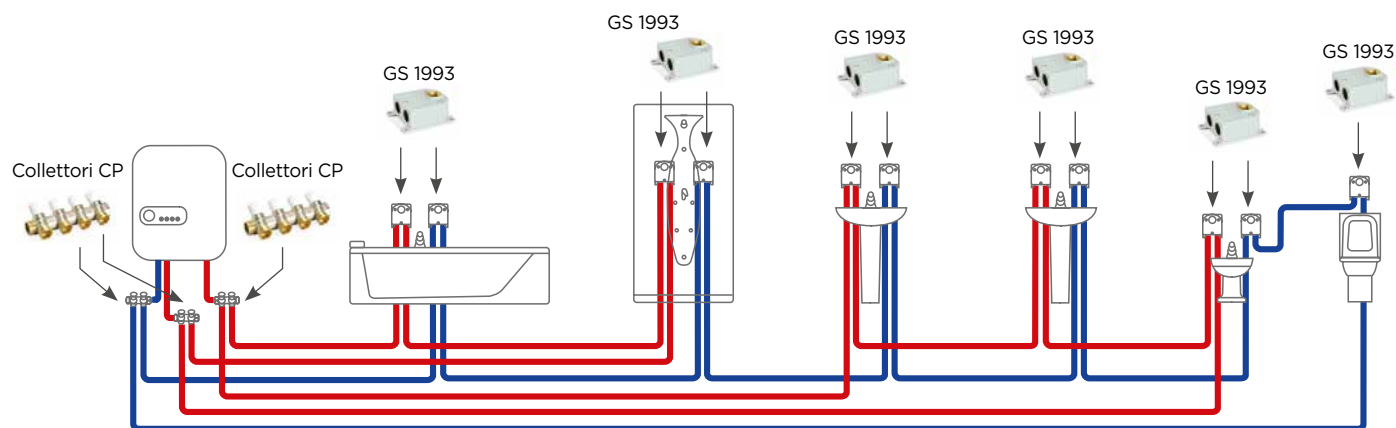

IMPIANTO PER LA DISTRIBUZIONE SANITARIA CON RICIRCOLO COMFORT

Questa tipologia di impianto prevede di realizzare un ricircolo per l'acqua calda.

I **vantaggi** di questo tipo di impianti sono:

- massimo comfort, in quanto l'acqua calda è immediatamente disponibile, indipendentemente dalla distanza dalla caldaia.

Gli **svantaggi** sono:

- elevato costo di realizzazione;
- utilizzo di tubi coibentati per ridurre la dispersione termica;
- realizzazione di un apposito circuito di ricircolo.

RACCORDI SOTTOTRACCIA PER LA DISTRIBUZIONE CON TUBI SFILABILI

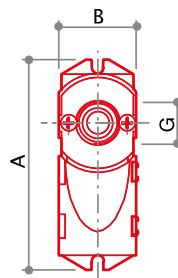

GS 1995

Raccordo curvo sottotraccia a 90° singolo di colore blu o rosso, senza staffa e con tappo in ottone con o-ring per prova di tenuta.

Raccordi

CODICE	MISURA	A	B	C	D	E	F	G	H	L			
66004100B	G 1/2 x (W24x19)	104	38	50	-	-	W24x19	G 1/2	-	-	124	8	64
66004100R	G 1/2 x (W24x19)	104	38	50	-	-	W24x19	G 1/2	-	-	124	8	64
66004102B*	G 1/2 x G 3/4 EK	104	38	50	-	-	G 3/4 EK	G 1/2	-	-	127	8	64
66004102R*	G 1/2 x G 3/4 EK	104	38	50	-	-	G 3/4 EK	G 1/2	-	-	127	8	64



RC 914

Raccordo curvo sottotraccia 90°.

CODICE	MISURA	FINITURA						
68549899	G 1/2 x (W24x19)	GIALLA	TR 91	TP 95	TP 97	75	30	240
68549901	G 1/2 x G 3/4 EK	GIALLA	TR 91/A	TP 98	TP 99	78	30	240
68549899N	G 1/2 x (W24x19)	NICHELATA	TR 91	TP 95	TP 97	75	30	240
68549901N	G 1/2 x G 3/4 EK	NICHELATA	TR 91/A	TP 98	TP 99	78	30	240

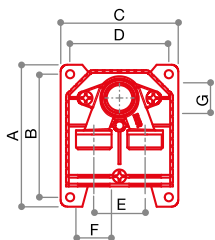

GS 1993

Raccordo doppio, sistema monotubo, con alloggiamento sottotraccia.

Raccordi

CODICE	MISURA	A	B	C	D	E	F	G	H	L			
66002200	G 1/2 x (W24x19)	105	91	87	73	38	W24x19	G 1/2	-	-	288	6	48
66002201*	G 1/2 x G 3/4 EK	105	91	87	73	38	G 3/4 EK	G 1/2	-	-	294	6	48

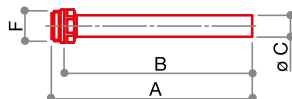

M 528

Tubo di raccordo in rame cromato a tenuta morbida per scatola di distribuzione sottotraccia.

CODICE	MISURA	A	B	C	D	E	F	G	H	L			
67510015	G 1/2 x (Ø 15 x 140)	140	131	15	-	-	G 1/2	-	-	-	70	35	280
67520015	G 1/2 x (Ø 15 x 175)	175	166	15	-	-	G 1/2	-	-	-	80	30	240

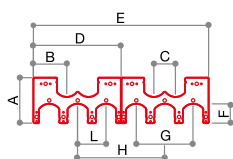

SS 1982

Staffa doppia frazionabile in due staffe singole per raccordi sottotraccia: art. GS 1995, GS 1996 interasse 38-50-100-153.

CODICE	MISURA	A	B	C	D	E	F	G	H	L			
66004000	-	80	58	38	154	308	34	100	153	50	142	25	150

RACCORDI PER TUBI IN RAME, PLASTICA E MULTISTRATO

CARATTERISTICHE TECNICHE



Max temperatura

120 °C



Max pressione

10 bar



CARATTERISTICHE COSTRUTTIVE

I raccordi Luxor sono prodotti in ottone con finitura gialla o nichelata in due versioni:

- resistente alla dezincificazione CW626N UNI EN 12165:2016;
- a basso contenuto di piombo in conformità alle più recenti normative: CW617N UNI EN 12165:2016.

Gli o-ring e le altre guarnizioni di tenuta sono in EPDM perossidico. La staffa articolo SS 1984 è in ferro zincato Fe Z100-EN 10142-92.

Questa staffa permette di posizionare con velocità e sicurezza i raccordi agli interessi corretti.

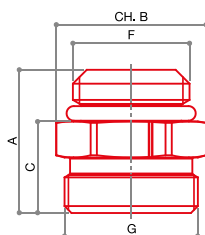

RD 900

Raccordo diretto con tenuta o-ring per collegamento ai collettori di distribuzione serie CD.

Raccordi

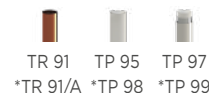

CODICE	MISURA	A	B	C	D	E	F	G	H	L	FINITURA			
68559824	G 1/2 x (W24x19)	26	24	16.5	-	-	G 1/2	W24x19	-	-	GIALLA	42	50	400
68552700*	G 1/2 x G 3/4 EK	26	27	17	-	-	G 1/2	G 3/4 EK	-	-	GIALLA	51	50	400
68559817N**	G 3/8 x (W24x19)	24	24	15	-	-	G 3/8	W24x19	-	-	NICHELATA	36	100	800
68559824N	G 1/2 x (W24x19)	26	24	16.5	-	-	G 1/2	W24x19	-	-	NICHELATA	42	50	400
68552700N*	G 1/2 x G 3/4 EK	26	27	17	-	-	G 1/2	G 3/4 EK	-	-	NICHELATA	51	50	400

** Articolo in esaurimento

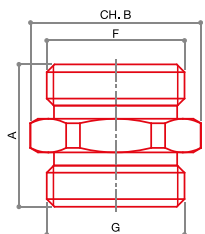

RD 902

Raccordo diretto M-M.

Raccordi



CODICE	MISURA	A	B	C	D	E	F	G	H	L			
68549824N	G 1/2 x (W24x19)	32.5	24	-	-	-	R 1/2	W24x19	-	-	46	50	400
68549827N	G 3/4 x (W24x19)	27	27	-	-	-	G 3/4 EK	W24x19	-	-	46	50	400
68559822N	(W24x19) x (W24x19)	26.5	24	-	-	-	W24x19	W24x19	-	-	42	50	400
68559823N*	G 3/4 EK x G 3/4 EK	27.5	30	-	-	-	G 3/4 EK	G 3/4 EK	-	-	62	50	400



Raccordi per tubo rame



Raccordi per tubo plastica

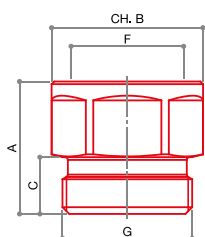

Raccordi per tubo multistrato

**RD 903**

Raccordo diritto F-M.

Raccordi

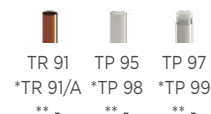

CODICE	MISURA	A	B	C	D	E	F	G	H	L			
68549838N	G 1/2 x (W24x19)	24.5	25	10.5	-	-	G 1/2	W24x19	-	-	42	50	400
68549739N*	G 1/2 x G 3/4 EK	26	27	10.5	-	-	G 1/2	G 3/4 EK	-	-	60	50	400
68549743N*	G 3/4 x G 3/4 EK	25	30	10.5	-	-	G 3/4	G 3/4 EK	-	-	51	50	400
68549740N	G 3/4 x (W24x19)	25	31	10.5	-	-	G 3/4	W24x19	-	-	58	50	400
68549741N	(W24x19) x (W24x19)	25	27	10	-	-	W24x19	W24x19	-	-	48	50	400
68549742N**	(W24x19) x G 1/2	24	27	10	-	-	W24x19	G 1/2	-	-	40	50	400

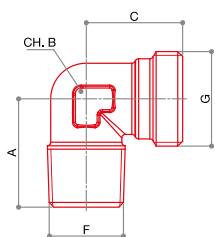
**RC 904**

Raccordo curvo M-M.

Raccordi

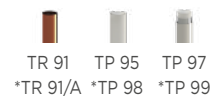

CODICE	MISURA	A	B	C	D	E	F	G	H	L			
68549847N	G 1/2 x (W24x19)	30	20	27	-	-	R 1/2	W24x19	-	-	64	50	400
68549746N*	G 1/2 x G 3/4 EK	30	20	27	-	-	R 1/2	G 3/4 EK	-	-	70	30	240

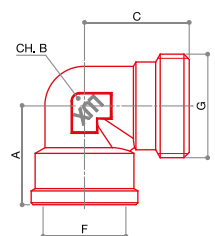
**RC 905**

Raccordo curvo F-M.

Raccordi

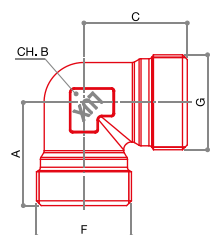

CODICE	MISURA	A	B	C	D	E	F	G	H	L			
68549856N	G 1/2 x (W24x19)	25	20	26.5	-	-	G 1/2	W24x19	-	-	79	50	400
68549755N*	G 1/2 x G 3/4 EK	25	20	26.5	-	-	G 1/2	G 3/4 EK	-	-	76	30	240
68549757N*	G 3/4 x G 3/4 EK	36.5	25	33	-	-	G 3/4	G 3/4 EK	-	-	148	25	200

**RC 906**

Raccordo curvo M-M.

Raccordi

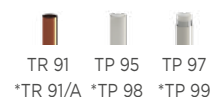

CODICE	MISURA	A	B	C	D	E	F	G	H	L			
68549865N	(W24x19) x (W24x19)	26	20	26	-	-	W24x19	W24x19	-	-	62	50	400
68549747N*	G 3/4 EK x G 3/4 EK	33	25	33	-	-	G 3/4 EK	G 3/4 EK	-	-	145	25	200



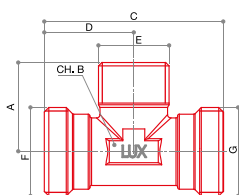

RT 907

Raccordo a T MxMxM.

Raccordi

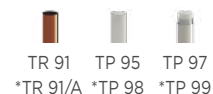

CODICE	MISURA	A	B	C	D	E	F	G	H	L			
68549870N	G 1/2 x (W24x19) x (W24x19)	30	20	53	26.5	G 1/2	W24x19	W24x19	-	-	82	30	240
68549770N*	G 1/2 x G 3/4 EK x G 3/4 EK	27	20	53	26.5	G 1/2	G 3/4 EK	G 3/4 EK	-	-	86	25	200

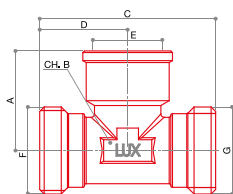

RT 908

Raccordo a T FxMxM.

Raccordi

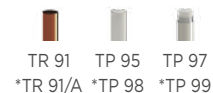

CODICE	MISURA	A	B	C	D	E	F	G	H	L			
68549879N	G 1/2 x (W24x19) x (W24x19)	30	20	53	26.5	G 1/2	W24x19	W24x19	-	-	98	30	240
68549779N*	G 1/2 x G 3/4 EK x G 3/4 EK	30	20	53	26.5	G 1/2	G 3/4 EK	G 3/4 EK	-	-	96	25	200

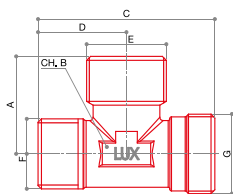

RT 909

Raccordo a T con attacco 1/2 M.

Raccordi



CODICE	MISURA	A	B	C	D	E	F	G	H	L			
68549888N	(W24x19) x G 1/2 x (W24x19)	29.5	20	53	26.5	W24x19	G 1/2	W24x19	-	-	100	30	240

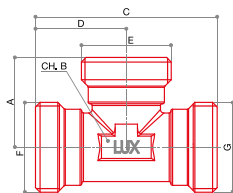

RT 911

Raccordo a T.

Raccordi

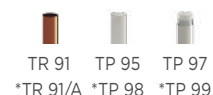

CODICE	MISURA	A	B	C	D	E	F	G	H	L			
68549890N	(W24x19) x (W24x19) x (W24x19)	26.5	20	53	26.5	W24x19	W24x19	W24x19	-	-	78	30	240
68549790N*	G 3/4 EK x G 3/4 EK x G 3/4 EK	26.5	20	53	26.5	G 3/4 EK	G 3/4 EK	G 3/4 EK	-	-	96	25	200



Raccordi per tubo rame



Raccordi per tubo plastica

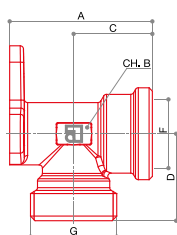

Raccordi per tubo multistrato

**RC 912**

Raccordo murale curvo con flangia.

Raccordi



CODICE	MISURA	A	B	C	D	E	F	G	H	L			
69549895N	G 1/2 x (W24x19)	43	19	24	26.5	-	G 1/2	W24x19	-	-	109	30	240
69549795N*	G 1/2 x G 3/4 EK	43.5	19	24	26.5	-	G 1/2	G 3/4 EK	-	-	100	25	200
69549794N*	G 3/4 x G 3/4 EK	57	21	37	27	-	G 3/4	G 3/4 EK	-	-	138	20	160

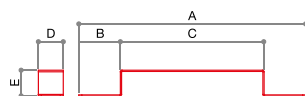

**SS 1984**

Staffa per raccordi murali con flangia art. RC 912 e RM.

CODICE	MISURA	A	B	C	D	E	F	G	H	L			
66001200	-	382	70	242	42	43.5	-	-	-	-	280	-	50

**RD 923**

Raccordo diritto con attacco maschio e raccordo portagomma fisso per tubo in polietilene rivestito (multistrato).

CODICE	MISURA			
69549925N	G 3/4 x 25 x 2,5	170	15	120
69549926N	G 3/4 x 26 x 3	172	15	120
69549927N	G 1" x 32 x 3	255	12	96

**RC 480**

Raccordo curvo in tre pezzi con tenuta o-ring.

CODICE	MISURA	FINITURA			
67952100	G 1/2	GIALLA	128	25	200
67952700	G 3/4	GIALLA	212	15	120
67953400	G 1"	GIALLA	372	8	64
67952100N	G 1/2	NICHELATA	128	25	200
67952700N	G 3/4	NICHELATA	212	15	120
67953400N	G 1"	NICHELATA	372	8	64



**RD 482**

Raccordo diritto in tre pezzi con tenuta o-ring.

CODICE	MISURA	FINITURA			
67972100	G 1/2	GIALLA	105	30	240
67972700	G 3/4	GIALLA	175	15	120
67973400	G 1"	GIALLA	303	12	96
67972100N	G 1/2	NICHELATA	105	30	240
67972700N	G 3/4	NICHELATA	175	15	120
67973400N	G 1"	NICHELATA	303	12	96



**RC 481**

Raccordo curvo nichelato in tre pezzi con doppia tenuta o-ring.

CODICE	MISURA			
67952101N	G 1/2	128	20	160
67952701N	G 3/4	212	12	96
67953401N	G 1"	372	6	48

**RD 483**

Raccordo diritto nichelato in tre pezzi con doppia tenuta o-ring.

CODICE	MISURA			
67972101N	G 1/2	106	25	200
67972701N	G 3/4	162	12	96
67973401N	G 1"	256	10	80

**CH 110**

Chiave per raccordi a compressione.

CODICE	MISURA			
67822724	CH 24-27 mm	352	10	80



LUXOR[®]

TUBI FLESSIBILI

TUBI FLESSIBILI



I tubi flessibili Luxor Spa sono prodotti di assoluta qualità Made in Italy, qualità e affidabilità riconosciuta ed apprezzata in tutto il mondo.

Le loro ottime caratteristiche igieniche e meccaniche, la praticità di installazione e l'economicità del prodotto trovano sempre maggiore interesse da parte di fabbricanti, installatori e commercianti. L'attenzione costante alle richieste del mercato, alle esigenze dei clienti e ai requisiti igienici e ambientali fanno dei tubi flessibili Luxor Spa un chiaro punto di riferimento nel mercato idrosanitario.

I tubi flessibili Luxor sono realizzati secondo la norma EN 13618.

I tubi flessibili Luxor sono la soluzione ideale per ogni tipo di installazione che richieda la conduzione di acque potabili e sanitarie: affidabili, facili da installare, economici. Il processo

produttivo della Luxor Spa è all'avanguardia per l'alta tecnologia delle macchine di produzione le quali garantiscono una corretta esecuzione del prodotto in tutte le sue fasi.

I tubi flessibili vengono inoltre verificati attraverso meticolose procedure di controllo che includono l'utilizzo di telecamere ad alta risoluzione in grado di rilevare eventuali difettosità di prodotto al 100% durante la fase di produzione.

Il Sistema di gestione della Qualità e i tubi flessibili Luxor Spa sono stati approvati e certificati dai più importanti Istituti di Certificazione Internazionali, i quali hanno riconosciuto e apprezzato oltre alle spiccate soluzioni tecniche legate ai prodotti, anche la politica aziendale nettamente rivolta alla soddisfazione del cliente e all'adempimento dei requisiti normativi cogenti ai prodotti realizzati.



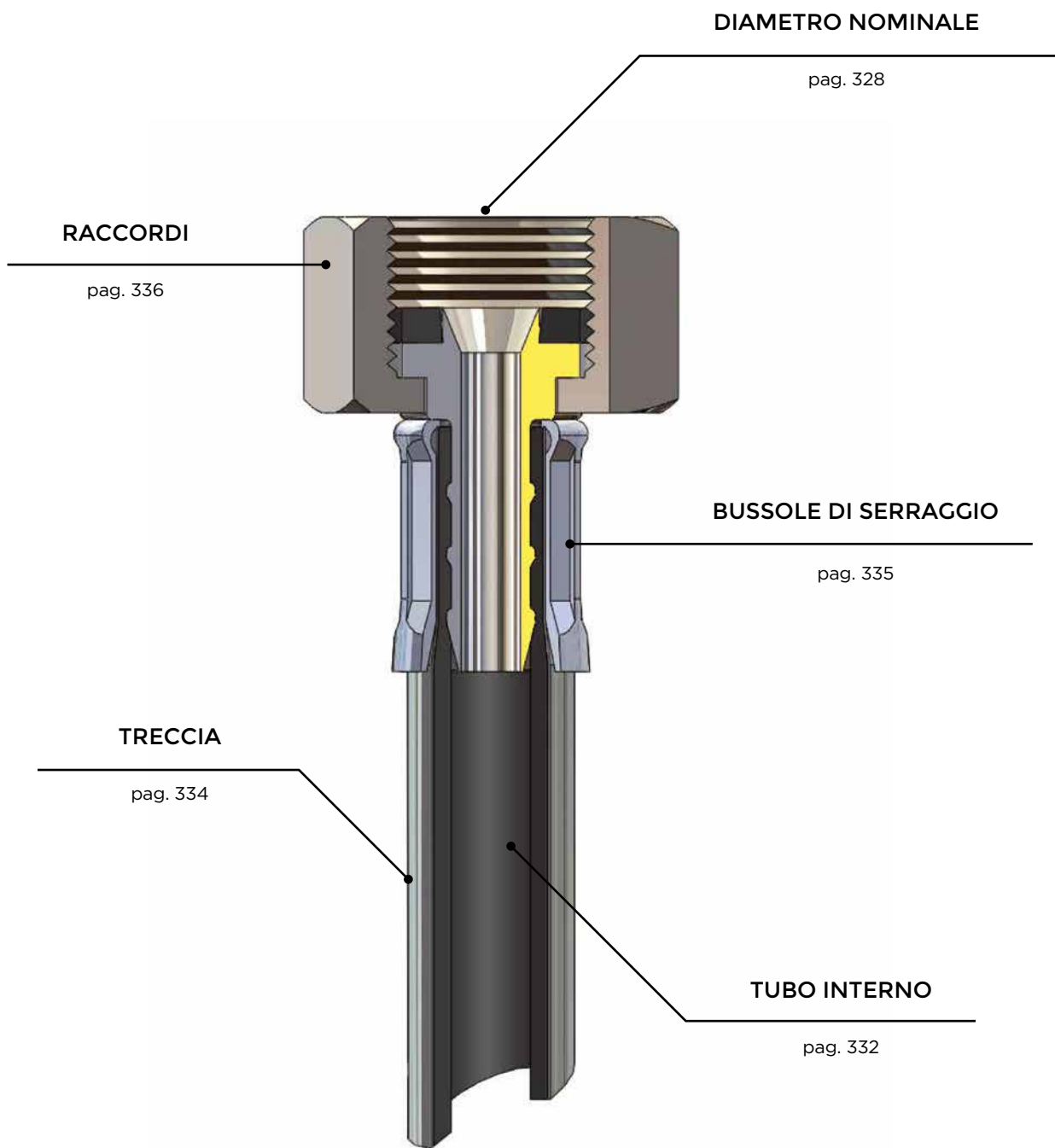

CAMPI DI APPLICAZIONE

pag. 330

CERTIFICAZIONI

pag. 340

ISTRUZIONI DI INSTALLAZIONE

pag. 438

ISTRUZIONI DI LUNGHEZZA

















pag. 440

DIAMETRO NOMINALE



La gamma dei tubi flessibili Luxor Spa comprende prodotti in conformità alle più importanti normative di prodotti internazionali e alla recente normativa europea EN13618:2017.

Sotto riportata la tabella delle caratteristiche tecniche principali per ogni diametro nominale e la loro disponibilità con gli inliner Silicone, Termoplastico, Epdm, Pex.

Gamma Tubo Interno	Diametro Nominale	∅ Interno mm	∅ Esterno mm	Raggio min. curvatura mm	∅ Interno raccordi mm	Portata a 3 bar	Pressione max esercizi	Temperatura max esercizio	Raccordi disponibili	Treccia disponibile
										
	DN6	6,3	10	40	4,7	16 l/min	10 Bar	70° C	Ottone, acciaio inox, plastica	Acciaio inox Nylon PA 6.6
	DN8	8,5	12	48	6,2	28 l/min	10 Bar	70° C	Ottone, acciaio inox, plastica	Acciaio inox Nylon PA 6.6
	DN10	9,4	13	56	7,5	46 l/min	10 Bar	70° C	Ottone, rame, acciaio inox, plastica	Acciaio inox Nylon PA 6.6
	DN13	12,5	18	72	10	74 l/min	10 Bar	70° C	Ottone, rame, acciaio inox, plastica	Acciaio inox Nylon PA 6.6
	DN15	15	20	80	12,5	83 l/min	10 Bar	110° C	Ottone, rame, acciaio inox, acciaio zincato	Acciaio inox Acciaio zincato
	DN18	19	26	104	15,5	200 l/min	10 Bar	110° C	Ottone, rame, acciaio inox, acciaio zincato	Acciaio inox Acciaio zincato
	DN25	25,5	33	132	21	280 l/min	10 Bar	110° C	Ottone, rame, acciaio inox, acciaio zincato	Acciaio inox Acciaio zincato
	DN32	32	42	168	27	490 l/min	6 Bar	110° C	Ottone, acciaio inox, acciaio zincato	Acciaio inox Acciaio zincato
	DN40	40	53	212	32	800 l/min	6 Bar	110° C	Ottone, acciaio inox, acciaio zincato	Acciaio inox Acciaio zincato
	DN50	50	65	275	41	1300 l/min	6 Bar	110° C	Ottone, acciaio inox, acciaio zincato	Acciaio inox Acciaio zincato

DIAGRAMMI DI PORTATA

Diagrammi di portata ottenuti su tubi flessibili con raccordi diritti e lunghezza di 1400 mm.

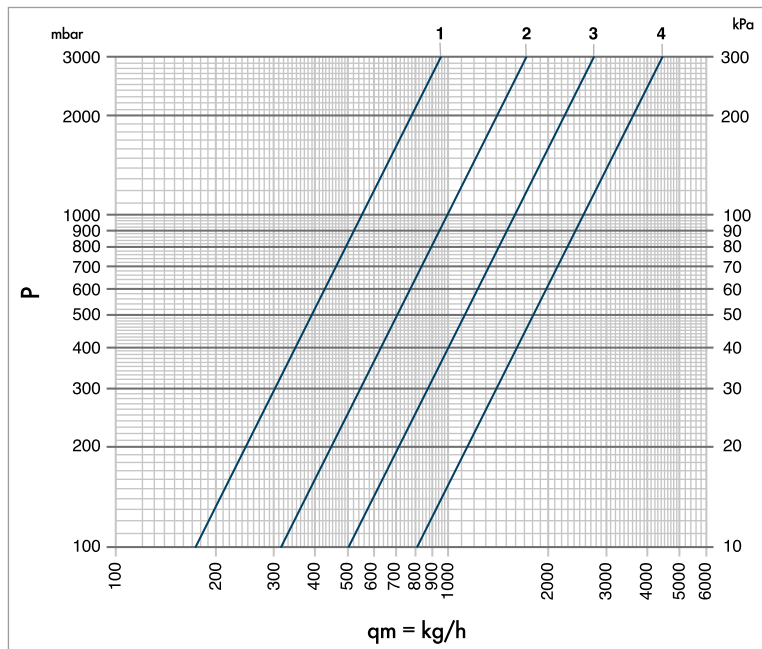

DIMENSIONI TUBO	POS	Kv	Portata in l/min con ΔP 3 bar
DN 6	1	0,55	16
DN 8	2	0,97	28
DN 10	3	1,59	46
DN 13	4	2,56	74

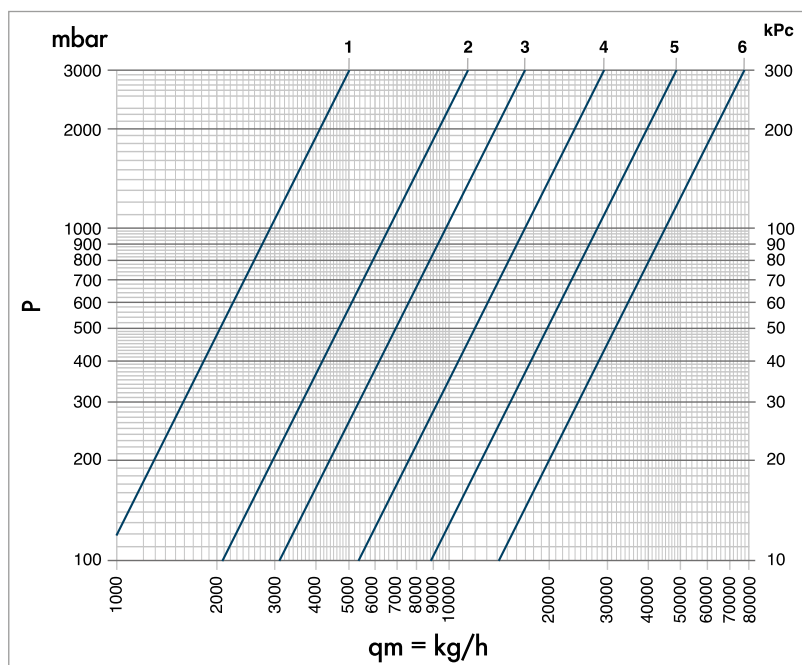

DIMENSIONI TUBO	POS	Kv	Portata in l/min con ΔP 3 bar
DN 15	1	2,9	83
DN 18	2	6,6	200
DN 25	3	9,8	280
DN 30	4	17	490
DN 40	5	28	800
DN 50	6	45	1300

CAMPI DI APPLICAZIONE

I tubi flessibili Luxor SpA sono la soluzione ideale per ogni tipo di applicazione, sia che si tratti di conduzione di acqua potabile che di installazioni industriali.

I tubi flessibili Luxor SpA sono sicuri e facili da installare.

Sotto riportati in tabella solo alcuni dei più comuni campi di applicazione e la loro disponibilità con gli inliner Silicone, Termoplastico, EPDM, PEX.



rubinetto tradizionale



rubinetti miscelatori



impianti di riscaldamento



cassette di scarico



caldaie



doccetta cucina



installazioni generiche

impianti
condizionamento / fan coil

lavatrici



colonne montanti



scaldabagni



lavastoviglie



cabine doccia



vasche idromassaggio



pompe



macchine da caffè

Gamma Tubo Interno																								
Diametro Nominale		Rubinetto monocomando	Rubinetto tradizionali	Rubinetto miscelatori	Rub. misc. con doccetta estraibile	Rubinetto monoforo	Macchine da caffè	Cassette di scarico	Installazioni idrauliche	Installazioni sanitarie	Scaldabagni	Tubi carico	Contatori acqua	Vasche idromassaggio	Cabine doccia	Fan-coil	Impianti riscaldamento	Pompe	Autoclavi	Pompe di calore	Impianti condizionamento	Serre	Colonne montanti	Installazioni idrauliche generiche
	DN6	●		●			●																	
	DN8	●	●	●	●	●	●	●	●	●														
	DN10		●						●	●	●	●												
	DN13								●	●	●	●	●	●	●	●	●							
	DN15																●	●	●	●	●	●	●	
	DN18																●	●	●	●	●	●	●	
	DN25																●	●	●	●	●	●	●	
	DN32																●	●	●			●	●	
	DN40																●	●	●			●	●	
	DN50																●	●	●			●	●	

TUBO INTERNO

SILICONE

Il silicone platinico, materiale pregiato di altissima qualità, sta raccogliendo sempre più consenso sui mercati idrosanitari internazionali. Questa è la versione più pura disponibile sul mercato e capace di garantire la piena alimentariet  del prodotto. Alcune delle caratteristiche peculiari sono il mantenimento di un'ottima elasticit  e delle propriet  meccaniche per tutto il range di temperatura di servizio.



TERMOPLASTICO

Frutto di anni di ricerca e sviluppo dei materiali pi  nobili e performanti, la nuova linea di tubi flessibili Luxor in materiale termoplastico coniuga l'assoluta purezza e l'igienicit  del Pex e del Silicone e con le grandi propriet  meccaniche dei tubi flessibili in EPDM. La flessibilit , la versatilit , la completezza della gamma di utilizzo fanno dei tubi flessibili in termoplastico Luxor un prodotto di alta qualit  riconosciuta in tutto il mondo e certificata dai pi  importanti Istituti di Certificazione di prodotto. I tubi flessibili in termoplastico Luxor sono stati progettati per rispettare la salute dei consumatori e l'ambiente che ci circonda: igienicamente puri e completamente riciclabili.



EPDM

La gomma EPDM perossidica   il materiale pi  utilizzato per la realizzazione del tubo interno. Con diverse composizioni chimiche, ha propriet  igieniche e meccaniche di alto livello, unitamente ad un'assoluta resistenza all'ossidazione, agli agenti atmosferici ed alle alte temperature.



PEX

Il PEX   un materiale termoplastico dalle alte qualit  igieniche che mantiene inalterati sapori ed odori dell'acqua di contatto per tutto il range di temperatura. I flessibili prodotti con questo materiale si sono affermati sul mercato idro sanitario come valida alternativa al tubo flessibile in EPDM.





CARATTERISTICHE	SILICONE	TERMOPLASTICO	EPDM	PEX
Purezza Igienica	●●●●●	●●●●	●●●	●●●●
Resistenza Meccanica	●●●	●●●●	●●●●●	●●●
Resistenza Alte Temperature	●●●●●	●●●●	●●●●●	●●
Durata	●●●●●	●●●●●	●●●●	●●●
Flessibilità	●●●●●	●●●●●	●●●●	●
Omologazioni	●●●●●	●●●●●	●●●	●●●
Completezza Gamma	●●●●	●●●	●●●●●	●
Versatilità	●●●●●	●●●	●●●●●	●

● Sufficiente ●● Discreto ●●● Buono ●●●● Ottimo ●●●●● Eccellente

TRECCIA



La treccia esterna di rinforzo viene realizzata utilizzando fili di acciaio inox AISI 304 \varnothing 0,20 mm, \varnothing 0,22 mm, fili in acciaio zincato \varnothing 0,30 mm e fili in Nylon PA 6.6 \varnothing 0,25 mm e \varnothing 0,30 mm.

Questi fili, trasformati in bandelle e assemblati a totale copertura del tubo interno garantiscono al flessibile di sopportare le normali pressioni di esercizio e le eventuali sovrappressioni che si possono generare durante il normale funzionamento di un impianto idraulico.

FILI IN ACCIAIO

I fili in acciaio hanno un diametro minimo di \varnothing 0,20 mm, una dimensione superiore a quella che solitamente viene utilizzata da altri produttori, a garanzia di un prodotto sicuro e affidabile, un prodotto di qualità superiore. L'ottimo materiale di rivestimento ha permesso ai tubi flessibili Luxor Spa di superare i più severi test meccanici richiesti dagli Istituti di Certificazione europei ed extraeuropei del settore idrosanitario.

FILI IN NYLON

Anche i fili in Nylon PA 6.6 assicurano un'ottima resistenza

e buone caratteristiche meccaniche grazie all'elasticità del materiale e all'eccellente comportamento ad alte e basse temperature. I tubi flessibili con trecciatura in Nylon PA 6.6 hanno trovato larga diffusione ad esempio tra i miscelatori da cucina con doccetta estraibile grazie alla loro resistenza all'usura da sfregamento e alla bassa rumorosità prodotta durante l'utilizzo quotidiano.

RICOPERTURA

La percentuale di ricopertura può variare in base a quanto previsto dalle certificazioni di prodotto e alle richieste del cliente, si parte da una ricopertura al 97% fino ad arrivare ad una ricopertura all'80%.

La ricopertura al 97% riveste perfettamente il tubo interno rendendo il flessibile meccanicamente più resistente alle sollecitazioni e offrendo un aspetto estetico nettamente superiore.

Le dimensioni del filo, la qualità del materiale e la percentuale di ricopertura distinguono i tubi flessibili Luxor Spa, prodotti di alto profilo qualitativo, da quelli di altri produttori.



BUSSOLE DI SERRAGGIO

La bussole di serraggio dei raccordi vengono realizzate in acciaio inox AISI 304 (dal DN6 al DN50) e in alluminio (dal DN15 al DN50), materiali sicuri che a differenza dell'ottone non sono soggetti alle rotture da tensocorrosione.

Oltre alle peculiari qualità specifiche dell'acciaio, ossia la resistenza alla corrosione e all'ossidazione, le bussole in acciaio inox AISI 304 vengono solubilizzate per distendere e ridurre la durezza superficiale del materiale evitando così il formarsi di cricche durante la fase di pressatura.

SERRAGGIO

Il serraggio delle bussole al tubo trecciato e ai raccordi di collegamento avviene mediante una sicura pressatura otta-

gonale o raggiata.

Per particolari esigenze dimensionali, come interessi dei fori miscelatori molto ridotti, si può eseguire anche una doppia pressatura chiamata "calibratura" che permette di ridurre ulteriormente l'ingombro esterno della bussola di serraggio.

MARCATURA

Tutti i tubi flessibili Luxor Spa vengono rigorosamente contrassegnati dalla marcatura di riconoscimento sulle bussole di serraggio indicanti marchio LUX, anno di produzione e riferimenti tecnico-normativi.

Con la marcatura ogni fabbricante si assume la responsabilità di ciò che produce: **DIFFIDATE DEI TUBI ANONIMI!**



RACCORDI



I raccordi di collegamento vengono realizzati utilizzando ottone CW617N e CW614N a basso contenuto di piombo in conformità alle più recenti normative UNI EN12165 e UNI EN12164.

Per alcuni mercati, o per specifici utilizzi, sono disponibili inoltre raccordi in ottone CW602N, CW625N, CW626N, CW724R, CW511L che si distinguono dall'ottone comunemente utilizzato in quanto evita il fenomeno della dezincificazione, ossia la corrosione causata dalla perdita dello zinco e dal conseguente rideposito del rame.

Sebbene le percentuali di piombo all'interno delle leghe in ottone per i raccordi siano basse e garantite da norme europee, la nuova sfida che si pone ai produttori di materiale idraulico è l'eliminazione totale del piombo dagli articoli realizzati. Con l'obiettivo fondamentale di migliorare costantemente le caratteristiche igieniche dei prodotti ed elevare sempre più la purezza di materiali, Luxor Spa si è impegnata ad utilizzare per particolari mercati ottone CW724R, CW511L, CW510L con percentuale di piombo nulla.

I raccordi, in base alle specifiche richieste del mercato o da quanto previsto dalle certificazioni di prodotto, vengono poi sottoposti a ulteriori processi di lavorazione come il trattamento di normalizzazione (per distendere il materiale, ridurre la durezza superficiale ed evitare la formazione di cricche di lavorazione).

Per particolari utilizzi, dove sono necessarie alte resistenze all'ossidazione e ottima resistenza a sollecitazioni meccaniche i raccordi vengono realizzati in acciaio inox AISI304.

Altri raccordi sono invece realizzati in rame disossidato al fosforo qualità Cu-DHP con composizione chimica Cu 99,9% min, le cui caratteristiche meccaniche, le dimensioni e le tolleranze sono rispondenti alla norma EN1057 e norme ad essa collegate.

Sono inoltre disponibili, su particolari richieste e per mercati di profilo minore raccordi in acciaio AVP.

GUARNIZIONI E O-RING

La tenuta idraulica dei raccordi è garantita dall'utilizzo di Guarnizioni e o-ring in EPDM e NBR, materiali ad alta proprietà antiozono, che preservano le loro caratteristiche di tenuta e di resistenza meccanica nel tempo.

Le mescole utilizzate, grazie alle loro ottime proprietà igieniche, sono idonee all'adduzione di acqua potabile e sono state approvate dai più severi enti di certificazione di prodotto del settore idrosanitario.

Le caratteristiche meccaniche, fisiche e igieniche delle guarnizioni e degli O-Ring vengono appurate attentamente eseguendo specifici test di laboratorio interni e esterni per verificare la rispondenza alle norme previste.



TIPOLOGIA DI RACCORDI

Soddisfare le esigenze del cliente nella fase di progettazione dei prodotti e proporre nuove soluzioni tecniche sono obiettivi primari della Luxor Spa.

Gamma Tubo Interno	Diametro Nominale								
<ul style="list-style-type: none"> ● Silicene ● EPDM ● Termoplastico ● PEX 	DN6	Maschio corto M 8x1 - 18 mm M 10x1 - 18 mm M 11x1 - 20 mm		Maschio medio M 8x1 - 44 mm M 10x1 - 44 mm		Maschio Lungo M 8x1 - 74 mm M 10x1 - 74 mm		Astina Liscia ø 10 mm	
		Astina Scalino ø 8 mm ø 10 mm		Femmina senza guarnizione G 1/4 - G 3/8 - G 1/8 G 1/2 - M 10x1 M 15x1 M 12x1 - 9/16 - 24 unef		Ghiera G 1/2		Maschio G 1/8 G 3/8 G 1/2	
		Maschi Girevoli M 12x1 M 15x1 G 3/8		Femmina con guarnizione G 3/8 - G 1/2 M 10x1 - M 15x1 9/16 - 24 unef					

Gamma Tubo Interno	Diametro Nominale								
<ul style="list-style-type: none"> ● Silicene ● EPDM ● Termoplastico 	DN8	Maschio corto M 10x1 - 18 mm M 11x1 - 19 mm M 12x1 - 19 mm		Maschio medio M 10x1 - 46 mm M 12x1 - 43 mm		Maschio Lungo M 10x1 - 74 mm M 12x1 - 75 mm		Astina Liscia ø 10 mm ø 15 mm	
		Astina Scalino ø 10 mm		Maschio G 1/4 G 3/8 G 1/2 G 3/4		Femmina senza guarnizione G 1/4 - G 3/8 - G 1/2 G 3/4 - M 15x1		Femmina Curva senza guarnizione G 1/4 - G 3/8 G 1/2 - G 3/4	
		Raccordo a Stringere ø 10 mm ø 12 mm ø 14 mm ø 15 mm		Maschi Girevoli M 15x1 G 3/8 G 1/2		Ghiera G 1/2		Femmina con o-ring G 3/8	
		Femmina Curva con o-ring G 3/8		Femmina con guarnizione G 3/8 - G 1/2 G 3/4 - 1/2 NPSM 9/16 - 24 unef		Femmina Curva con guarnizione G 3/8 - G 1/2 G 3/4		Maschio Prolungato G 3/8 - 26 mm G 1/2 - 28 mm	

Gamma Tubo Interno	Diametro Nominale								
<ul style="list-style-type: none"> ● EPDM ● Termoplastico 	DN10	Maschio corto M 12x1 - 16 mm		Maschio G 1/4 G 3/8 G 1/2		Femmina senza guarnizione G 3/8 G 1/2 G 3/4		Femmina Curva senza guarnizione G 3/8 G 1/2 G 3/4	
		Raccordo a Stringere ø 10 mm ø 12 mm ø 14 mm ø 15 mm		Femmina Alettata con e senza o-ring G 1/2		Maschi Girevoli G 3/8 G 1/2		Push-Fit Ottone ø 12	
		Femmina con guarnizione G 3/8 - G 1/2 G 3/4		Femmina Curva con guarnizione G 1/2 - G 3/4		Maschio Prolungato G 3/8 - 26 mm G 1/2 - 28 mm			

Gamma Tubo Interno	Diametro Nominale								
<ul style="list-style-type: none"> ● Silicene ● EPDM ● Termoplastico 	DN13	Maschio G 3/8 G 1/2 G 3/4		Femmina senza guarnizione G 3/8 G 1/2 G 3/4		Femmina Curva senza guarnizione G 1/2 G 3/4 G 1"		Astina Liscia ø 15 mm	
		Astina Scalino ø 15 mm		Raccordo a Stringere ø 12 mm ø 15 mm		Push-Fit Ottone ø 12		Femmina con guarnizione G 1/2 - G 3/4	
		Femmina Curva con guarnizione G 1/2 - G 3/4		Maschio Prolungato G 1/2 - 28 mm					

Gamma Tubo Interno	Diametro Nominale								
<ul style="list-style-type: none"> ● EPDM 	DN15	Maschio G 1/2 G 3/4		Femmina G 1/2 G 3/4		Femmina Curva G 1/2 G 3/4		Astina Liscia ø 15 mm	

Gamma Tubo Interno	Diametro Nominale								
<ul style="list-style-type: none"> ● Silicone ● EPDM 	DN18	Maschio G 3/4 G 1"		Femmina G 3/4 G 1"		Femmina Curva G 3/4 G 1"		Astina Liscia ø 22 mm	

Gamma Tubo Interno	Diametro Nominale								
<ul style="list-style-type: none"> ● Silicone ● EPDM 	DN25	Maschio G 1"		Femmina G 1" G 1" 1/4 G 1" 1/2		Femmina Curva G 1"		Astina Liscia ø 28 mm	

Gamma Tubo Interno	Diametro Nominale				
<ul style="list-style-type: none"> ● Silicone ● EPDM 	DN32	Maschio G 1" 1/4		Femmina G 1" 1/4	
		Femmina Curva G 1" 1/4			

Gamma Tubo Interno	Diametro Nominale		
<ul style="list-style-type: none"> ● EPDM 	DN40	Maschio G 1" 1/2	
		Femmina G 1" 1/2	

Gamma Tubo Interno	Diametro Nominale		
<ul style="list-style-type: none"> ● EPDM 	DN50	Maschio G 2"	
		Femmina G 2"	

CERTIFICAZIONI

Diametro
Nominale

DN6	 Nazione: Italia Certificazione: DM 174 Tubo Interno:	 Nazione: Australia Certificazione: WATERMARK Tubo Interno:	 Nazione: Danimarca Certificazione: VA Tubo Interno:
	 Nazione: Francia Certificazione: QB Tubo Interno:	 Nazione: Germania Certificazione: DVGW Tubo Interno:	 Nazione: Norvegia Certificazione: SINTEF Tubo Interno:
	 Nazione: Olanda Certificazione: KIWA Tubo Interno:	 Nazione: Svizzera Certificazione: SVGW Tubo Interno:	 Nazione: Svezia Certificazione: RISE Tubo Interno:
	 Nazione: U.S.A. Certificazione: NSF - IAPMO Tubo Interno: (NSF - IAPMO) (NSF)	 Nazione: UE Certificazione: EN 13618 Tubo Interno:	 Nazione: UK Certificazione: WRAS Tubo Interno:

Diametro
Nominale

DN8	 Nazione: Italia Certificazione: DM 174 Tubo Interno:	 Nazione: Australia Certificazione: WATERMARK Tubo Interno:	 Nazione: Danimarca Certificazione: VA Tubo Interno:
	 Nazione: Francia Certificazione: QB Tubo Interno:	 Nazione: Germania Certificazione: DVGW - TÜV Tubo Interno: (DVGW - TÜV) (DVGW)	 Nazione: Norvegia Certificazione: SINTEF Tubo Interno:
	 Nazione: Olanda Certificazione: KIWA Tubo Interno:	 Nazione: Svizzera Certificazione: SVGW Tubo Interno:	 Nazione: Svezia Certificazione: RISE Tubo Interno:
	 Nazione: U.S.A. Certificazione: NSF - IAPMO Tubo Interno:	 Nazione: UE Certificazione: EN 13618 Tubo Interno:	 Nazione: UK Certificazione: WRAS Tubo Interno:

Silicene
 EPDM
 Termoplastico
 PEX

Per informazioni sulle specifiche tecniche e sui prodotti certificati si prega di rivolgersi ai nostri uffici o visitare il sito web degli enti di certificazione corrispondenti. La lista completa dei prodotti certificati NSF è consultabile al sito www.nsf.org. La lista completa dei prodotti certificati UPC/CUPC è consultabile al sito www.iapmo.org.

Diametro
Nominale

DN10	 Nazione: Italia Certificazione: DM 174 Tubo Interno:	 Nazione: Australia Certificazione: WATERMARK Tubo Interno:	 Nazione: Danimarca Certificazione: VA Tubo Interno:
	 Nazione: Francia Certificazione: QB Tubo Interno:	 Nazione: Germania Certificazione: DVGW - TÜV Tubo Interno:	 Nazione: Norvegia Certificazione: SINTEF Tubo Interno:
	 Nazione: Olanda Certificazione: KIWA Tubo Interno:	 Nazione: Svizzera Certificazione: SVGW Tubo Interno:	 Nazione: Svezia Certificazione: RISE Tubo Interno:
	 Nazione: U.S.A. Certificazione: NSF - IAPMO Tubo Interno:	 Nazione: UE Certificazione: EN 13618 Tubo Interno:	 Nazione: UK Certificazione: WRAS Tubo Interno:

Diametro
Nominale

DN13	 Nazione: Italia Certificazione: DM 174 Tubo Interno:	 Nazione: Australia Certificazione: WATERMARK Tubo Interno:	 Nazione: Danimarca Certificazione: VA Tubo Interno:
	 Nazione: Francia Certificazione: QB Tubo Interno:	 Nazione: Germania Certificazione: DVGW - TÜV Tubo Interno:	 Nazione: Norvegia Certificazione: SINTEF Tubo Interno:
	 Nazione: Olanda Certificazione: KIWA Tubo Interno:	 Nazione: Svizzera Certificazione: SVGW Tubo Interno:	 Nazione: Svezia Certificazione: RISE Tubo Interno:
	 Nazione: U.S.A. Certificazione: NSF - IAPMO Tubo Interno:	 Nazione: UE Certificazione: EN 13618 Tubo Interno:	 Nazione: UK Certificazione: WRAS Tubo Interno:















Silicone
 EPDM
 Termoplastico
 PEX

Per informazioni sulle specifiche tecniche e sui prodotti certificati si prega di rivolgersi ai nostri uffici o visitare il sito web degli enti di certificazione corrispondenti. La lista completa dei prodotti certificati NSF è consultabile al sito www.nsf.org. La lista completa dei prodotti certificati UPC/CUPC è consultabile al sito www.iapmo.org.

Diametro
Nominale

DN15		Nazione: Francia 		Nazione: Germania 	EN 13618 	
		Certificazione: QB		Certificazione: TÜV		Certificazione: EN 13618
		Tubo Interno: 		Tubo Interno: 		Tubo Interno: 









Diametro
Nominale

DN18		Nazione: Francia 	 	Nazione: Germania 	EN 13618 	
		Certificazione: QB		Certificazione: DVGW - TÜV		Certificazione: EN 13618
		Tubo Interno: 		Tubo Interno:  (DVGW - TÜV)  (TÜV)		Tubo Interno:  
		Nazione: UK 				
		Certificazione: WRAS				
		Tubo Interno: 				

Diametro
Nominale

DN25		Nazione: Francia 	 	Nazione: Germania 	EN 13618 	
		Certificazione: QB		Certificazione: DVGW - TÜV		Certificazione: EN 13618
		Tubo Interno: 		Tubo Interno:  (DVGW - TÜV)  (TÜV)		Tubo Interno:  

Diametro
Nominale

DN32		Nazione: Francia 	 	Nazione: Germania 
		Certificazione: QB		Certificazione: DVGW - TÜV
		Tubo Interno: 		Tubo Interno:  (DVGW - TÜV)  (TÜV)

Diametro
Nominale

DN40		Nazione: Francia 		Nazione: Germania 
		Certificazione: QB		Certificazione: TÜV
		Tubo Interno: 		Tubo Interno: 

Diametro
Nominale

DN50		Nazione: Francia 		Nazione: Germania 
		Certificazione: QB		Certificazione: TÜV
		Tubo Interno: 		Tubo Interno: 

 Silicone EPDM

Per informazioni sulle specifiche tecniche e sui prodotti certificati si prega di rivolgersi ai nostri uffici o visitare il sito web degli enti di certificazione corrispondenti. La lista completa dei prodotti certificati NSF è consultabile al sito www.nsf.org. La lista completa dei prodotti certificati UPC/CUPC è consultabile al sito www.iapmort.org.



TUBI FLESSIBILI BAGNO

1.1 / FLEXY MIX

FLEXY MIX

IDEALE PER RUBINETTERIA



È la soluzione ideale per l'allacciamento dalla rete idrica a qualsiasi tipo di rubinetto e miscelatore. La combinazione tra treccia inox e il tubo interno in EPDM

permette un collegamento flessibile, semplice e sicuro. È un prodotto di alta qualità, in conformità ai requisiti internazionali del settore.

CARATTERISTICHE TECNICHE



DN

8



Max temperatura

70 °C



Max pressione

10 bar



Portata a 3 bar

28 l/min



Raggio min. di curvatura 48 mm



Tubo interno

EPDM



Treccia

INOX AISI 304



Raccordi

CW617N

CAMPI DI APPLICAZIONE



rubinetto tradizionale



rubinetti miscelatori

TUBO INTERNO



EPDM

La gomma EPDM perossidica è il materiale più utilizzato per la realizzazione del tubo interno.

Con diverse composizioni chimiche, ha proprietà igieniche e meccaniche di alto livello, unitamente ad un'assoluta resistenza all'ossidazione, agli agenti atmosferici ed alle alte temperature.

TIPOLOGIA DI RACCORDI

Maschio corto
M 10x1 - 18 mm



Maschio medio
M 10x1 - 46 mm



Femmina con guarnizione inserita
G 3/8
G 1/2



Astina con scalino
Ø 10 mm



Raccordo a stringere
G 3/8 Ø 10 mm



CERTIFICAZIONI

EN 13618
UE



Istruzioni
Pag. 438

Per informazioni sulle specifiche tecniche e sui prodotti certificati si prega di rivolgersi ai nostri uffici o visitare il sito web degli enti di certificazione corrispondenti.

FX 801

● M 10x1



● G 3/8

Maschio Corto

Femmina con guarnizione inserita

CODICE	RACCORDI	DN	LUNGHEZZA mm			
CGAKLS0200LAL	Maschio Corto M 10x1 Femmina con guarnizione inserita G 3/8	8	200	63	-	25
CGAKLS0250LAL			250	70	-	25
CGAKLS0300LAL			300	76	-	25
CGAKLS0350LAL			350	83	-	25
CGAKLS0400LAE			400	90	10	-
CGAKLS0500LAE			500	104	10	-
CGAKLS0600LAE			600	117	10	-

FX 802

● M 10x1



● G 1/2

Maschio Corto

Femmina con guarnizione inserita

CODICE	RACCORDI	DN	LUNGHEZZA mm			
CGAKJS0200LAL	Maschio Corto M 10x1 Femmina con guarnizione inserita G 1/2	8	200	78	-	25
CGAKJS0250LAL			250	85	-	25
CGAKJS0300LAL			300	92	-	25
CGAKJS0350LAL			350	99	-	25
CGAKJS0400LAE			400	106	10	-
CGAKJS0500LAE			500	119	10	-
CGAKJS0600LAE			600	133	10	-

FX 803

● M 10x1



● G 3/8

Maschio Medio

Femmina con guarnizione inserita

CODICE	RACCORDI	DN	LUNGHEZZA mm			
CGASES0200LAL	Maschio Medio M 10x1 Femmina con guarnizione inserita G 3/8	8	200	69	-	25
CGASES0250LAL			250	76	-	25
CGASES0300LAL			300	83	-	25
CGASES0350LAL			350	90	-	25
CGASES0400LAE			400	96	10	-
CGASES0500LAE			500	110	10	-
CGASES0600LAE			600	124	10	-

FX 804

● M 10x1



● G 1/2

Maschio Medio

Femmina con guarnizione inserita

CODICE	RACCORDI	DN	LUNGHEZZA mm			
CGASDS0200LAL	Maschio Medio M 10x1 Femmina con guarnizione inserita G 1/2	8	200	85	-	25
CGASDS0250LAL			250	92	-	25
CGASDS0300LAL			300	98	-	25
CGASDS0350LAL			350	105	-	25
CGASDS0400LAE			400	112	10	-
CGASDS0500LAE			500	126	10	-
CGASDS0600LAE			600	139	10	-



DN
8



Max temperatura
70 °C



Max pressione
10 bar



Portata a 3 bar
28 l/min



Raggio min. di curvatura
48 mm



Tubo interno
EPDM



Treccia
INOX AISI 304



Raccordi
CW617N



Istruzioni
Pag. 438

FX 805

● $\varnothing 10$ mm



● G 3/8 $\varnothing 10$ mm

Astina con scalino

Raccordo a stringere

CODICE	RACCORDI	DN	LUNGHEZZA mm			
CGA3GS0200LAL	Astina con scalino $\varnothing 10$ mm Raccordo a stringere G 3/8 $\varnothing 10$ mm	8	200	75	-	25
CGA3GS0250LAL			250	82	-	25
CGA3GS0300LAL			300	89	-	25
CGA3GS0350LAL			350	96	-	25
CGA3GS0400LAE			400	102	10	-
CGA3GS0500LAE			500	116	10	-
CGA3GS0600LAE			600	130	10	-



DN
8



Max temperatura
70 °C



Max pressione
10 bar



Portata a 3 bar
28 l/min



Raggio min. di curvatura
48 mm



Tubo interno
EPDM



Treccia
INOX AISI 304



Raccordi
CW617N



Istruzioni
Pag. 438



TUBI FLESSIBILI BAGNO

1.2 / FLEXY MIX PT+

FLEXY MIX PT+

SPECIALE RUBINETTERIA IN SILICONE



Il tubo interno in Silicone Platinico conferisce a tubi flessibili eccellenti proprietà igieniche nonché un'elevata resistenza alla pressione e alla temperatura.

Il rivestimento interno resistente ai prodotti chimici protegge dagli additivi dell'acqua potabile. È quindi particolarmente indicato per ambienti con requisiti igienici rigorosi come per esempio strutture sanitarie.

CARATTERISTICHE TECNICHE



DN

8



Max temperatura

70 °C



Max pressione

10 bar



Portata a 3 bar

28 l/min



Raggio min. di curvatura
48 mm



Tubo interno
SILICONE



Treccia
INOX AISI 304



Raccordi
CW617N

CAMPI DI APPLICAZIONE



rubinetto tradizionale



rubinetti miscelatori

TUBO INTERNO



SILICONE

Il silicone platinico, materiale pregiato di altissima qualità, sta raccogliendo sempre più consenso sui mercati idrosanitari internazionali.

Questa è la versione più pura disponibile sul mercato e capace di garantire la piena alimentarietà del prodotto. Alcune delle caratteristiche peculiari sono il mantenimento di un'ottima elasticità e delle proprietà meccaniche per tutto il range di temperatura di servizio.

TIPOLOGIA DI RACCORDI

Maschio corto
M 10x1 - 18mm



Maschio medio
M 10x1 - 46 mm



Femmina con guarnizione inserita
G 3/8
G 1/2



CERTIFICAZIONI

DM 174
Italia



EN 13618
UE



DVGW
Germania



Istruzioni
Pag. 438

Per informazioni sulle specifiche tecniche e sui prodotti certificati si prega di rivolgersi ai nostri uffici o visitare il sito web degli enti di certificazione corrispondenti.

FP 801

● M 10x1



● G 3/8

Maschio Corto

Femmina con guarnizione inserita

CODICE	RACCORDI	DN	LUNGHEZZA mm			
CHQKLS0200DML	Maschio Corto M 10x1 Femmina con guarnizione inserita G 3/8	8	200	58	-	25
CHQKLS0250DML			250	65	-	25
CHQKLS0300DML			300	71	-	25
CHQKLS0350DML			350	77	-	25
CHQKLS0400DME			400	84	10	-
CHQKLS0500DME			500	96	10	-
CHQKLS0600DME			600	109	10	-

FP 802

● M 10x1



● G 1/2

Maschio Corto

Femmina con guarnizione inserita

CODICE	RACCORDI	DN	LUNGHEZZA mm			
CHQKJS0200DML	Maschio Corto M 10x1 Femmina con guarnizione inserita G 1/2	8	200	62	-	25
CHQKJS0250DML			250	69	-	25
CHQKJS0300DML			300	75	-	25
CHQKJS0350DML			350	81	-	25
CHQKJS0400DME			400	88	10	-
CHQKJS0500DME			500	100	10	-
CHQKJS0600DME			600	113	10	-

FP 803

● M 10x1



● G 3/8

Maschio Medio

Femmina con guarnizione inserita

CODICE	RACCORDI	DN	LUNGHEZZA mm			
CHQSES0200DML	Maschio Medio M 10x1 Femmina con guarnizione inserita G 3/8	8	200	66	-	25
CHQSES0250DML			250	72	-	25
CHQSES0300DML			300	79	-	25
CHQSES0350DML			350	85	-	25
CHQSES0400DME			400	91	10	-
CHQSES0500DME			500	104	10	-
CHQSES0600DME			600	116	10	-

FP 804

● M 10x1



● G 1/2

Maschio Medio

Femmina con guarnizione inserita

CODICE	RACCORDI	DN	LUNGHEZZA mm			
CHQSDS0200DML	Maschio Medio M 10x1 Femmina con guarnizione inserita G 1/2	8	200	70	-	25
CHQSDS0250DML			250	76	-	25
CHQSDS0300DML			300	83	-	25
CHQSDS0350DML			350	89	-	25
CHQSDS0400DME			400	95	10	-
CHQSDS0500DME			500	108	10	-
CHQSDS0600DME			600	120	10	-



DN
8



Max temperatura
70 °C



Max pressione
10 bar



Portata a 3 bar
28 l/min



Raggio min. di curvatura
48 mm



Tubo interno
SILICONE



Treccia
INOX AISI 304



Raccordi
CW617N



Istruzioni
Pag. 438

Lined writing area with horizontal lines.



TUBI FLESSIBILI BAGNO

1.3 / OMNYFLEX 8

OMNYFLEX 8

APPLICAZIONI GENERICHE



Il tubo più tradizionale e versatile con interno in EPDM.
Questo tubo flessibile si presta a diversi campi di applicazione.

CARATTERISTICHE TECNICHE



DN

8



Max temperatura

70 °C



Max pressione

10 bar



Portata a 3 bar

28 l/min



Raggio min.
di curvatura
48 mm



Tubo interno

EPDM



Treccia

INOX AISI
304



Raccordi

CW617N

CAMPI DI APPLICAZIONE



cassette di scarico



caldaie



installazioni generiche

TUBO INTERNO



EPDM

La gomma EPDM perossidica è il materiale più utilizzato per la realizzazione del tubo interno.

Con diverse composizioni chimiche, ha proprietà igieniche e meccaniche di alto livello, unitamente ad un'assoluta resistenza all'ossidazione, agli agenti atmosferici ed alle alte temperature.

TIPOLOGIA DI RACCORDI

Maschio

G 3/8
G 1/2



Maschio Prolungato

G 3/8 - 26 mm
G 1/2 - 28 mm



Femmina con guarnizione inserita

G 3/8
G 1/2



Raccordo a stringere

G 3/8 Ø 10 mm



Maschio Girevole

G 1/2



Maschio Prolungato con rosetta scorrevole

G 3/8 - 26 mm
G 1/2 - 28 mm



CERTIFICAZIONI

EN 13618

UE



Istruzioni
Pag. 438

Per informazioni sulle specifiche tecniche e sui prodotti certificati si prega di rivolgersi ai nostri uffici o visitare il sito web degli enti di certificazione corrispondenti.

OF 801

● G 3/8



● G 3/8

Maschio

Femmina con guarnizione inserita

CODICE	RACCORDI	DN	LUNGHEZZA mm			
CGACFS0200LAL	Maschio G 3/8 Femmina con guarnizione inserita G 3/8	8	200	66	-	25
CGACFS0250LAL			250	73	-	25
CGACFS0300LAL			300	79	-	25
CGACFS0350LAL			350	85	-	25
CGACFS0400LAE			400	92	10	-
CGACFS0500LAE			500	105	10	-
CGACFS0600LAE			600	117	10	-
CGACFS0800LAE			800	143	10	-
CGACFS1000LAE			1000	169	10	-

OF 802

● G 3/8



● G 1/2

Maschio

Femmina con guarnizione inserita

CODICE	RACCORDI	DN	LUNGHEZZA mm			
CGACDS0200LAL	Maschio G 3/8 Femmina con guarnizione inserita G 1/2	8	200	69	-	25
CGACDS0250LAL			250	76	-	25
CGACDS0300LAL			300	82	-	25
CGACDS0350LAL			350	88	-	25
CGACDS0400LAE			400	95	10	-
CGACDS0500LAE			500	108	10	-
CGACDS0600LAE			600	120	10	-
CGACDS0800LAE			800	146	10	-
CGACDS1000LAE			1000	172	10	-

OF 803

● G 1/2



● G 3/8

Maschio

Femmina con guarnizione inserita

CODICE	RACCORDI	DN	LUNGHEZZA mm			
CGAEWS0200LAL	Maschio G 1/2 Femmina con guarnizione inserita G 3/8	8	200	80	-	25
CGAEWS0250LAL			250	86	-	25
CGAEWS0300LAL			300	93	-	25
CGAEWS0350LAL			350	99	-	25
CGAEWS0400LAE			400	105	10	-
CGAEWS0500LAE			500	118	10	-
CGAEWS0600LAE			600	131	10	-
CGAEWS0800LAE			800	157	10	-
CGAEWS1000LAE			1000	182	10	-

OF 804

● G 1/2



● G 1/2

Maschio

Femmina con guarnizione inserita

CODICE	RACCORDI	DN	LUNGHEZZA mm			
CGAEVS0200LAL	Maschio G 1/2 Femmina con guarnizione inserita G 1/2	8	200	83	-	25
CGAEVS0250LAL			250	89	-	25
CGAEVS0300LAL			300	96	-	25
CGAEVS0350LAL			350	102	-	25
CGAEVS0400LAE			400	108	10	-
CGAEVS0500LAE			500	121	10	-
CGAEVS0600LAE			600	134	10	-
CGAEVS0800LAE			800	160	10	-
CGAEVS1000LAE			1000	185	10	-



DN
8



Max temperatura
70 °C



Max pressione
10 bar



Portata a 3 bar
28 l/min



Raggio min. di curvatura
48 mm



Tubo interno
EPDM



Trecia
INOX AISI 304



Raccordi
CW617N



Istruzioni
Pag. 438

OF 805

● G 3/8



● G 3/8

Femmina con guarnizione inserita

Femmina con guarnizione inserita

CODICE	RACCORDI	DN	LUNGHEZZA mm				
CGAGUS0200LAL	Femmina con guarnizione inserita G 3/8	8	200	69	-	25	
CGAGUS0250LAL			250	74	-	25	
CGAGUS0300LAL			300	80	-	25	
CGAGUS0350LAL			350	87	-	25	
CGAGUS0400LAE			Femmina con guarnizione inserita G 3/8	400	93	10	-
CGAGUS0500LAE				500	106	10	-
CGAGUS0600LAE				600	119	10	-
CGAGUS0800LAE				800	144	10	-
CGAGUS1000LAE				1000	170	10	-

OF 806

● G 1/2



● G 3/8

Femmina con guarnizione inserita

Femmina con guarnizione inserita

CODICE	RACCORDI	DN	LUNGHEZZA mm			
CGAGNS0200LAL	Femmina con guarnizione inserita G 1/2	8	200	72	-	25
CGAGNS0250LAL			250	77	-	25
CGAGNS0300LAL			300	83	-	25
CGAGNS0350LAL			350	90	-	25
CGAGNS0400LAE			Femmina con guarnizione inserita G 3/8	400	96	10
CGAGNS0500LAE	500	109		10	-	
CGAGNS0600LAE	600	122		10	-	
CGAGNS0800LAE	800	147		10	-	
CGAGNS1000LAE	1000	173		10	-	

OF 807

● G 1/2



● G 1/2

Femmina con guarnizione inserita

Femmina con guarnizione inserita

CODICE	RACCORDI	DN	LUNGHEZZA mm				
CGAGKS0200LAL	Femmina con guarnizione inserita G 1/2	8	200	75	-	25	
CGAGKS0250LAL			250	80	-	25	
CGAGKS0300LAL			300	86	-	25	
CGAGKS0350LAL			350	93	-	25	
CGAGKS0400LAE			Femmina con guarnizione inserita G 1/2	400	99	10	-
CGAGKS0500LAE				500	112	10	-
CGAGKS0600LAE				600	125	10	-
CGAGKS0800LAE				800	150	10	-
CGAGKS1000LAE				1000	176	10	-



DN
8



Max temperatura
70 °C



Max pressione
10 bar



Portata a 3 bar
28 l/min



Raggio min. di curvatura
48 mm



Tubo interno
EPDM



Treccia
INOX AISI 304



Raccordi
CW617N



Istruzioni
Pag. 438

OF 808

● G 1/2



● G 3/8

Maschio Girevole

Femmina con guarnizione inserita

CODICE	RACCORDI	DN	LUNGHEZZA mm			
CGAD8S0200LAL	Maschio Girevole G 1/2 Femmina con guarnizione inserita G 3/8	8	200	104	-	25
CGAD8S0250LAL			250	110	-	25
CGAD8S0300LAL			300	116	-	25
CGAD8S0350LAL			350	123	-	25
CGAD8S0400LAE			400	129	10	-
CGAD8S0500LAE			500	142	10	-
CGAD8S0600LAE			600	155	10	-
CGAD8S0800LAE			800	180	10	-
CGAD8S1000LAE			1000	206	10	-

OF 809

● G 1/2



● G 1/2

Maschio Girevole

Femmina con guarnizione inserita

CODICE	RACCORDI	DN	LUNGHEZZA mm			
CGACMS0200LAL	Maschio Girevole G 1/2 Femmina con guarnizione inserita G 1/2	8	200	106	-	25
CGACMS0250LAL			250	112	-	25
CGACMS0300LAL			300	118	-	25
CGACMS0350LAL			350	125	-	25
CGACMS0400LAE			400	131	10	-
CGACMS0500LAE			500	144	10	-
CGACMS0600LAE			600	157	10	-
CGACMS0800LAE			800	182	10	-
CGACMS1000LAE			1000	208	10	-

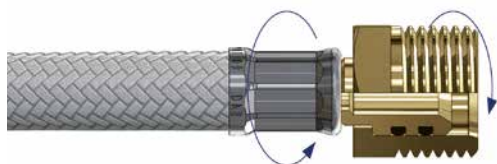

MASCHIO GIREVOLE

Il maschio girevole permette al tubo flessibile di ruotare liberamente dopo l'installazione.

Elimina i problemi di torsione e permette montaggi e destinazioni d'uso particolari.



DN
8



Max temperatura
70 °C



Max pressione
10 bar



Portata a 3 bar
28 l/min



Raggio min. di curvatura
48 mm



Tubo interno
EPDM



Treccia
INOX AISI 304



Raccordi
CW617N



Istruzioni
Pag. 438

OF 810

● G 3/8



● G 3/8

Maschio Prolungato

Femmina con guarnizione inserita

CODICE	RACCORDI	DN	LUNGHEZZA mm			
CGADJS0200LAL	Maschio Prolungato G 3/8 Femmina con guarnizione inserita G 3/8	8	200	74	-	25
CGADJS0250LAL			250	80	-	25
CGADJS0300LAL			300	87	-	25
CGADJS0350LAL			350	93	-	25
CGADJS0400LAE			400	100	10	-
CGADJS0500LAE			500	112	10	-
CGADJS0600LAE			600	125	10	-
CGADJS0800LAE			800	151	10	-
CGADJS1000LAE			1000	176	10	-

OF 811

● G 3/8



● G 1/2

Maschio Prolungato

Femmina con guarnizione inserita

CODICE	RACCORDI	DN	LUNGHEZZA mm			
CGADHS0200LAL	Maschio Prolungato G 3/8 Femmina con guarnizione inserita G 1/2	8	200	77	-	25
CGADHS0250LAL			250	83	-	25
CGADHS0300LAL			300	90	-	25
CGADHS0350LAL			350	96	-	25
CGADHS0400LAE			400	103	10	-
CGADHS0500LAE			500	115	10	-
CGADHS0600LAE			600	128	10	-
CGADHS0800LAE			800	154	10	-
CGADHS1000LAE			1000	179	10	-

OF 812

● G 1/2



● G 3/8

Maschio Prolungato

Femmina con guarnizione inserita

CODICE	RACCORDI	DN	LUNGHEZZA mm			
CGADES0200LAL	Maschio Prolungato G 1/2 Femmina con guarnizione inserita G 3/8	8	200	91	-	25
CGADES0250LAL			250	97	-	25
CGADES0300LAL			300	104	-	25
CGADES0350LAL			350	110	-	25
CGADES0400LAE			400	116	10	-
CGADES0500LAE			500	129	10	-
CGADES0600LAE			600	142	10	-
CGADES0800LAE			800	168	10	-
CGADES1000LAE			1000	193	10	-

OF 813

● G 1/2



● G 1/2

Maschio Prolungato

Femmina con guarnizione inserita

CODICE	RACCORDI	DN	LUNGHEZZA mm			
CGADDS0200LAL	Maschio Prolungato G 1/2 Femmina con guarnizione inserita G 1/2	8	200	94	-	25
CGADDS0250LAL			250	100	-	25
CGADDS0300LAL			300	107	-	25
CGADDS0350LAL			350	113	-	25
CGADDS0400LAE			400	119	10	-
CGADDS0500LAE			500	132	10	-
CGADDS0600LAE			600	145	10	-
CGADDS0800LAE			800	171	10	-
CGADDS1000LAE			1000	196	10	-



DN

8



Max temperatura

70 °C



Max pressione

10 bar



Portata a 3 bar

28 l/min



Raggio min. di curvatura

48 mm



Tubo interno

EPDM



Trezza

INOX AISI 304



Raccordi

CW617N



Istruzioni

Pag. 438

OF 814

● G 3/8



Maschio Prolungato
con rosetta scorrevole

Femmina con
guarnizione inserita

● G 3/8

CODICE	RACCORDI	DN	LUNGHEZZA mm			
CGADJS0200LAR	Maschio Prolungato con rosetta scorrevole G 3/8 Femmina con guarnizione inserita G 3/8	8	200	83	-	25
CGADJS0250LAR			250	89	-	25
CGADJS0300LAR			300	96	-	25
CGADJS0350LAR			350	102	-	25
CGADJS0400LAS			400	109	10	-
CGADJS0500LAS			500	121	10	-
CGADJS0600LAS			600	134	10	-
CGADJS0800LAS			800	160	10	-
CGADJS1000LAS			1000	185	10	-

OF 815

● G 3/8



Maschio Prolungato
con rosetta scorrevole

Femmina
con guarnizione inserita

● G 1/2

CODICE	RACCORDI	DN	LUNGHEZZA mm			
CGADHS0200LAR	Maschio Prolungato con rosetta scorrevole G 3/8 Femmina con guarnizione inserita G 1/2	8	200	86	-	25
CGADHS0250LAR			250	92	-	25
CGADHS0300LAR			300	99	-	25
CGADHS0350LAR			350	105	-	25
CGADHS0400LAS			400	112	10	-
CGADHS0500LAS			500	124	10	-
CGADHS0600LAS			600	137	10	-
CGADHS0800LAS			800	163	10	-
CGADHS1000LAS			1000	188	10	-

OF 816

● G 1/2



Maschio Prolungato
con rosetta scorrevole

Femmina con
guarnizione inserita

● G 3/8

CODICE	RACCORDI	DN	LUNGHEZZA mm			
CGADES0200LAR	Maschio Prolungato con rosetta scorrevole G 1/2 Femmina con guarnizione inserita G 3/8	8	200	99	-	25
CGADES0250LAR			250	105	-	25
CGADES0300LAR			300	112	-	25
CGADES0350LAR			350	118	-	25
CGADES0400LAS			400	124	10	-
CGADES0500LAS			500	137	10	-
CGADES0600LAS			600	150	10	-
CGADES0800LAS			800	176	10	-
CGADES1000LAS			1000	201	10	-

OF 817

● G 1/2



Maschio Prolungato
con rosetta scorrevole

Femmina con
guarnizione inserita

● G 1/2

CODICE	RACCORDI	DN	LUNGHEZZA mm			
CGADDS0200LAR	Maschio Prolungato con rosetta scorrevole G 1/2 Femmina con guarnizione inserita G 1/2	8	200	102	-	25
CGADDS0250LAR			250	108	-	25
CGADDS0300LAR			300	115	-	25
CGADDS0350LAR			350	121	-	25
CGADDS0400LAS			400	127	10	-
CGADDS0500LAS			500	140	10	-
CGADDS0600LAS			600	153	10	-
CGADDS0800LAS			800	179	10	-
CGADDS1000LAS			1000	204	10	-



DN
8



Max temperatura
70 °C



Max pressione
10 bar



Portata a 3 bar
28 l/min



Raggio min. di curvatura
48 mm



Tubo interno
EPDM



Treccia
INOX AISI 304



Raccordi
CW617N



Istruzioni
Pag. 438

OF 818

● G 3/8



Maschio

Raccordo a stringere

● G 3/8 Ø 10 mm

CODICE	RACCORDI	DN	LUNGHEZZA mm			
CGAQMS0200LAL	Maschio G 3/8 Raccordo a stringere G 3/8 Ø 10 mm	8	200	83	-	25
CGAQMS0250LAL			250	89	-	25
CGAQMS0300LAL			300	95	-	25
CGAQMS0350LAL			350	102	-	25
CGAQMS0400LAE			400	108	10	-
CGAQMS0500LAE			500	121	10	-
CGAQMS0600LAE			600	134	10	-
CGAQMS0800LAE			800	159	10	-
CGAQMS1000LAE			1000	185	10	-

OF 819

● G 1/2



Maschio

Raccordo a stringere

● G 3/8 Ø 10 mm

CODICE	RACCORDI	DN	LUNGHEZZA mm			
CGAQES0200LAL	Maschio G 1/2 Raccordo a stringere G 3/8 Ø 10 mm	8	200	96	-	25
CGAQES0250LAL			250	103	-	25
CGAQES0300LAL			300	109	-	25
CGAQES0350LAL			350	116	-	25
CGAQES0400LAE			400	122	10	-
CGAQES0500LAE			500	135	10	-
CGAQES0600LAE			600	148	10	-
CGAQES0800LAE			800	173	10	-
CGAQES1000LAE			1000	199	10	-

OF 820

● G 3/8



Femmina con guarnizione inserita

Raccordo a stringere

● G 3/8 Ø 10 mm

CODICE	RACCORDI	DN	LUNGHEZZA mm			
CGANWS0200LAL	Femmina con guarnizione inserita G 3/8 Raccordo a stringere G 3/8 Ø 10 mm	8	200	85	-	25
CGANWS0250LAL			250	92	-	25
CGANWS0300LAL			300	98	-	25
CGANWS0350LAL			350	104	-	25
CGANWS0400LAE			400	111	10	-
CGANWS0500LAE			500	124	10	-
CGANWS0600LAE			600	136	10	-
CGANWS0800LAE			800	162	10	-
CGANWS1000LAE			1000	188	10	-

OF 821

● G 1/2



Femmina con guarnizione inserita

Raccordo a stringere

● G 3/8 Ø 10 mm

CODICE	RACCORDI	DN	LUNGHEZZA mm			
CGANVS0200LAL	Femmina con guarnizione inserita G 1/2 Raccordo a stringere G 3/8 Ø 10 mm	8	200	87	-	25
CGANVS0250LAL			250	94	-	25
CGANVS0300LAL			300	100	-	25
CGANVS0350LAL			350	106	-	25
CGANVS0400LAE			400	113	10	-
CGANVS0500LAE			500	126	10	-
CGANVS0600LAE			600	138	10	-
CGANVS0800LAE			800	164	10	-
CGANVS1000LAE			1000	190	10	-



DN

8



Max temperatura

70 °C



Max pressione

10 bar



Portata a 3 bar

28 l/min



Raggio min. di curvatura

48 mm



Tubo interno

EPDM



Trezza

INOX AISI 304



Raccordi

CW617N



Istruzioni

Pag. 438

OF 822

● G 3/8



● G 3/8 Ø 10 mm

Maschio Prolungato

Raccordo a stringere

CODICE	RACCORDI	DN	LUNGHEZZA mm			
CGAQQS0200LAL	Maschio Prolungato G 3/8 Raccordo a stringere G 3/8 Ø 10 mm	8	200	91	-	25
CGAQQS0250LAL			250	97	-	25
CGAQQS0300LAL			300	103	-	25
CGAQQS0350LAL			350	110	-	25
CGAQQS0400LAE			400	116	10	-
CGAQQS0500LAE			500	117	10	-
CGAQQS0600LAE			600	130	10	-
CGAQQS0800LAE			800	156	10	-
CGAQQS1000LAE			1000	181	10	-

OF 823

● G 1/2



● G 3/8 Ø 10 mm

Maschio Prolungato

Raccordo a stringere

CODICE	RACCORDI	DN	LUNGHEZZA mm			
CGAQPS0200LAL	Maschio Prolungato G 1/2 Raccordo a stringere G 3/8 Ø 10 mm	8	200	107	-	25
CGAQPS0250LAL			250	114	-	25
CGAQPS0300LAL			300	120	-	25
CGAQPS0350LAL			350	126	-	25
CGAQPS0400LAE			400	133	10	-
CGAQPS0500LAE			500	134	10	-
CGAQPS0600LAE			600	147	10	-
CGAQPS0800LAE			800	173	10	-
CGAQPS1000LAE			1000	198	10	-

OF 824

● G 3/8

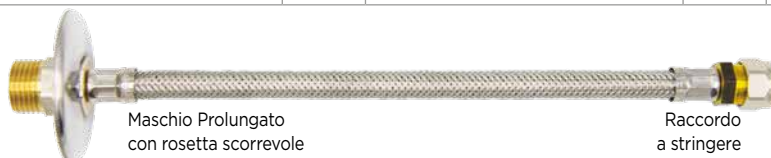

● G 3/8 Ø 10 mm

Maschio Prolungato
con rosetta scorrevole

Raccordo
a stringere

CODICE	RACCORDI	DN	LUNGHEZZA mm			
CGAQQS0200LAR	Maschio Prolungato con rosetta scorrevole G 3/8 Raccordo a stringere G 3/8 Ø 10 mm	8	200	100	-	25
CGAQQS0250LAR			250	106	-	25
CGAQQS0300LAR			300	112	-	25
CGAQQS0350LAR			350	119	-	25
CGAQQS0400LAS			400	125	10	-
CGAQQS0500LAS			500	126	10	-
CGAQQS0600LAS			600	139	10	-
CGAQQS0800LAS			800	165	10	-
CGAQQS1000LAS			1000	190	10	-

OF 825

● G 1/2

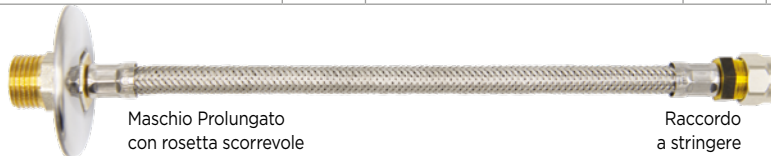

● G 3/8 Ø 10 mm

Maschio Prolungato
con rosetta scorrevole

Raccordo
a stringere

CODICE	RACCORDI	DN	LUNGHEZZA mm			
CGAQPS0200LAR	Maschio Prolungato con rosetta scorrevole G 1/2 Raccordo a stringere G 3/8 Ø 10 mm	8	200	115	-	25
CGAQPS0250LAR			250	122	-	25
CGAQPS0300LAR			300	128	-	25
CGAQPS0350LAR			350	134	-	25
CGAQPS0400LAS			400	141	10	-
CGAQPS0500LAS			500	142	10	-
CGAQPS0600LAS			600	155	10	-
CGAQPS0800LAS			800	181	10	-
CGAQPS1000LAS			1000	206	10	-



DN
8



Max temperatura
70 °C



Max pressione
10 bar



Portata a 3 bar
28 l/min



Raggio min. di curvatura
48 mm



Tubo interno
EPDM



Treccia
INOX AISI 304



Raccordi
CW617N



Istruzioni
Pag. 438



TUBI FLESSIBILI BAGNO

1.4 / OMNYFLEX PT+

OMNYFLEX PT+

APPLICAZIONI IN SILICONE



Il tubo più tradizionale e versatile con interno in silicone, adatto a diversi campi di applicazione. Il tubo interno in silicone platinico garantisce inoltre altissimi standard qualitativi.

vi, rendendo OMNYFLEX PT+ la soluzione ideale per installazioni in ambienti con requisiti igienici rigorosi.

CARATTERISTICHE TECNICHE



DN

8



Max temperatura

70 °C



Max pressione

10 bar



Portata a 3 bar

28 l/min



Raggio min. di curvatura
48 mm



Tubo interno

SILICONE



Treccia

INOX AISI 304



Raccordi

CW617N

CAMPI DI APPLICAZIONE



cassette di scarico



caldaie



installazioni generiche

TUBO INTERNO



SILICONE

Il silicone platinico, materiale pregiato di altissima qualità, sta raccogliendo sempre più consenso sui mercati idrosanitari internazionali.

Questa è la versione più pura disponibile sul mercato e capace di garantire la piena alimentarietà del prodotto. Alcune delle caratteristiche peculiari sono il mantenimento di un'ottima elasticità e delle proprietà meccaniche per tutto il range di temperatura di servizio.

TIPOLOGIA DI RACCORDI

Maschio

G 3/8
G 1/2



Maschio Prolungato

G 3/8 - 26 mm
G 1/2 - 28 mm



Femmina con guarnizione inserita

G 3/8
G 1/2



Maschio Prolungato con rosetta scorrevole

G 3/8 - 26 mm
G 1/2 - 28 mm



CERTIFICAZIONI

DM 174

Italia



EN 13618

UE



DVGW

Germania



Istruzioni
Pag. 438

Per informazioni sulle specifiche tecniche e sui prodotti certificati si prega di rivolgersi ai nostri uffici o visitare il sito web degli enti di certificazione corrispondenti.

OP 801

● G 3/8



● G 3/8

Maschio

Femmina con guarnizione inserita

CODICE	RACCORDI	DN	LUNGHEZZA mm			
CHQCF0200DML	Maschio G 3/8 Femmina con guarnizione inserita G 3/8	8	200	66	-	25
CHQCF0250DML			250	72	-	25
CHQCF0300DML			300	78	-	25
CHQCF0350DML			350	85	-	25
CHQCF0400DME			400	91	10	-
CHQCF0500DME			500	104	10	-
CHQCF0600DME			600	116	10	-
CHQCF0800DME			800	141	10	-
CHQCF1000DME			1000	167	10	-

OP 802

● G 3/8



● G 1/2

Maschio

Femmina con guarnizione inserita

CODICE	RACCORDI	DN	LUNGHEZZA mm			
CHQCD0200DML	Maschio G 3/8 Femmina con guarnizione inserita G 1/2	8	200	70	-	25
CHQCD0250DML			250	76	-	25
CHQCD0300DML			300	82	-	25
CHQCD0350DML			350	89	-	25
CHQCD0400DME			400	95	10	-
CHQCD0500DME			500	108	10	-
CHQCD0600DME			600	120	10	-
CHQCD0800DME			800	145	10	-
CHQCD1000DME			1000	171	10	-

OP 803

● G 1/2



● G 3/8

Maschio

Femmina con guarnizione inserita

CODICE	RACCORDI	DN	LUNGHEZZA mm			
CHQEWS0200DML	Maschio G 1/2 Femmina con guarnizione inserita G 3/8	8	200	79	-	25
CHQEWS0250DML			250	86	-	25
CHQEWS0300DML			300	92	-	25
CHQEWS0350DML			350	98	-	25
CHQEWS0400DME			400	105	10	-
CHQEWS0500DME			500	117	10	-
CHQEWS0600DME			600	130	10	-
CHQEWS0800DME			800	155	10	-
CHQEWS1000DME			1000	180	10	-

OP 804

● G 1/2



● G 1/2

Maschio

Femmina con guarnizione inserita

CODICE	RACCORDI	DN	LUNGHEZZA mm			
CHQEVS0200DML	Maschio G 1/2 Femmina con guarnizione inserita G 1/2	8	200	83	-	25
CHQEVS0250DML			250	90	-	25
CHQEVS0300DML			300	96	-	25
CHQEVS0350DML			350	102	-	25
CHQEVS0400DME			400	109	10	-
CHQEVS0500DME			500	121	10	-
CHQEVS0600DME			600	134	10	-
CHQEVS0800DME			800	159	10	-
CHQEVS1000DME			1000	184	10	-



DN
8



Max temperatura
70 °C



Max pressione
10 bar



Portata a 3 bar
28 l/min



Raggio min. di curvatura
48 mm



Tubo interno
SILICONE



Treccia
INOX AISI 304



Raccordi
CW617N



Istruzioni
Pag. 438

OP 805

● G 3/8



● G 3/8

Femmina con guarnizione inserita

Femmina con guarnizione inserita

CODICE	RACCORDI	DN	LUNGHEZZA mm			
CHQGUS0200DML	Femmina con guarnizione inserita G 3/8	8	200	68	-	25
CHQGUS0250DML			250	74	-	25
CHQGUS0300DML			300	81	-	25
CHQGUS0350DML			350	87	-	25
CHQGUS0400DME			Femmina con guarnizione inserita G 3/8	400	93	10
CHQGUS0500DME	500	106		10	-	
CHQGUS0600DME	600	119		10	-	
CHQGUS0800DME	800	144		10	-	
CHQGUS1000DME	1000	169		10	-	

OP 806

● G 3/8



● G 1/2

Femmina con guarnizione inserita

Femmina con guarnizione inserita

CODICE	RACCORDI	DN	LUNGHEZZA mm			
CHQGNS0200DML	Femmina con guarnizione inserita G 3/8	8	200	72	-	25
CHQGNS0250DML			250	78	-	25
CHQGNS0300DML			300	85	-	25
CHQGNS0350DML			350	91	-	25
CHQGNS0400DME			Femmina con guarnizione inserita G 1/2	400	97	10
CHQGNS0500DME	500	110		10	-	
CHQGNS0600DME	600	123		10	-	
CHQGNS0800DME	800	148		10	-	
CHQGNS1000DME	1000	173		10	-	

OP 807

● G 1/2



● G 1/2

Femmina con guarnizione inserita

Femmina con guarnizione inserita

CODICE	RACCORDI	DN	LUNGHEZZA mm			
CHQGKS0200DML	Femmina con guarnizione inserita G 1/2	8	200	76	-	25
CHQGKS0250DML			250	82	-	25
CHQGKS0300DML			300	89	-	25
CHQGKS0350DML			350	95	-	25
CHQGKS0400DME			Femmina con guarnizione inserita G 1/2	400	101	10
CHQGKS0500DME	500	114		10	-	
CHQGKS0600DME	600	127		10	-	
CHQGKS0800DME	800	152		10	-	
CHQGKS1000DME	1000	177		10	-	



DN
8



Max temperatura
70 °C



Max pressione
10 bar



Portata a 3 bar
28 l/min



Raggio min. di curvatura
48 mm



Tubo interno
SILICONE



Treccia
INOX AISI 304



Raccordi
CW617N



Istruzioni
Pag. 438

OP 808

● G 3/8



● G 3/8

Maschio Prolungato

Femmina con guarnizione inserita

CODICE	RACCORDI	DN	LUNGHEZZA mm			
CHQDJS0200DML	Maschio Prolungato G 3/8 Femmina con guarnizione inserita G 3/8	8	200	73	-	25
CHQDJS0250DML			250	80	-	25
CHQDJS0300DML			300	86	-	25
CHQDJS0350DML			350	92	-	25
CHQDJS0400DME			400	99	10	-
CHQDJS0500DME			500	111	10	-
CHQDJS0600DME			600	124	10	-
CHQDJS0800DME			800	149	10	-
CHQDJS1000DME			1000	175	10	-

OP 809

● G 3/8



● G 1/2

Maschio Prolungato

Femmina con guarnizione inserita

CODICE	RACCORDI	DN	LUNGHEZZA mm			
CHQDHS0200DML	Maschio Prolungato G 3/8 Femmina con guarnizione inserita G 1/2	8	200	77	-	25
CHQDHS0250DML			250	84	-	25
CHQDHS0300DML			300	90	-	25
CHQDHS0350DML			350	96	-	25
CHQDHS0400DME			400	103	10	-
CHQDHS0500DME			500	115	10	-
CHQDHS0600DME			600	128	10	-
CHQDHS0800DME			800	153	10	-
CHQDHS1000DME			1000	179	10	-

OP 810

● G 1/2



● G 3/8

Maschio Prolungato

Femmina con guarnizione inserita

CODICE	RACCORDI	DN	LUNGHEZZA mm			
CHQDES0200DML	Maschio Prolungato G 1/2 Femmina con guarnizione inserita G 3/8	8	200	90	-	25
CHQDES0250DML			250	97	-	25
CHQDES0300DML			300	103	-	25
CHQDES0350DML			350	109	-	25
CHQDES0400DME			400	115	10	-
CHQDES0500DME			500	128	10	-
CHQDES0600DME			600	141	10	-
CHQDES0800DME			800	166	10	-
CHQDES1000DME			1000	191	10	-

OP 811

● G 1/2



● G 1/2

Maschio Prolungato

Femmina con guarnizione inserita

CODICE	RACCORDI	DN	LUNGHEZZA mm			
CHQDDS0200DML	Maschio Prolungato G 1/2 Femmina con guarnizione inserita G 1/2	8	200	94	-	25
CHQDDS0250DML			250	101	-	25
CHQDDS0300DML			300	107	-	25
CHQDDS0350DML			350	113	-	25
CHQDDS0400DME			400	119	10	-
CHQDDS0500DME			500	132	10	-
CHQDDS0600DME			600	145	10	-
CHQDDS0800DME			800	170	10	-
CHQDDS1000DME			1000	195	10	-



DN
8



Max temperatura
70 °C



Max pressione
10 bar



Portata a 3 bar
28 l/min



Raggio min. di curvatura
48 mm



Tubo interno
SILICONE



Treccia
INOX AISI 304



Raccordi
CW617N



Istruzioni
Pag. 438

OP 812

● G 3/8



Maschio Prolungato
con rosetta scorrevole

Femmina con
guarnizione inserita

● G 3/8

CODICE	RACCORDI	DN	LUNGHEZZA mm			
CHQDJS0200DMR	Maschio Prolungato con rosetta scorrevole G 3/8 Femmina con guarnizione inserita G 3/8	8	200	103	-	25
CHQDJS0250DMR			250	110	-	25
CHQDJS0300DMR			300	116	-	25
CHQDJS0350DMR			350	122	-	25
CHQDJS0400DMS			400	129	10	-
CHQDJS0500DMS			500	141	10	-
CHQDJS0600DMS			600	154	10	-
CHQDJS0800DMS			800	179	10	-
CHQDJS1000DMS			1000	205	10	-

OP 813

● G 3/8



Maschio Prolungato
con rosetta scorrevole

Femmina con
guarnizione inserita

● G 1/2

CODICE	RACCORDI	DN	LUNGHEZZA mm			
CHQDHS0200DMR	Maschio Prolungato con rosetta scorrevole G 3/8 Femmina con guarnizione inserita G 1/2	8	200	99	-	25
CHQDHS0250DMR			250	106	-	25
CHQDHS0300DMR			300	112	-	25
CHQDHS0350DMR			350	118	-	25
CHQDHS0400DMS			400	125	10	-
CHQDHS0500DMS			500	137	10	-
CHQDHS0600DMS			600	150	10	-
CHQDHS0800DMS			800	175	10	-
CHQDHS1000DMS			1000	201	10	-

OP 814

● G 1/2



Maschio Prolungato
con rosetta scorrevole

Femmina con
guarnizione inserita

● G 3/8

CODICE	RACCORDI	DN	LUNGHEZZA mm			
CHQDES0200DMR	Maschio Prolungato con rosetta scorrevole G 1/2 Femmina con guarnizione inserita G 3/8	8	200	87	-	25
CHQDES0250DMR			250	93	-	25
CHQDES0300DMR			300	99	-	25
CHQDES0350DMR			350	106	-	25
CHQDES0400DMS			400	112	10	-
CHQDES0500DMS			500	125	10	-
CHQDES0600DMS			600	137	10	-
CHQDES0800DMS			800	163	10	-
CHQDES1000DMS			1000	188	10	-

OP 815

● G 1/2

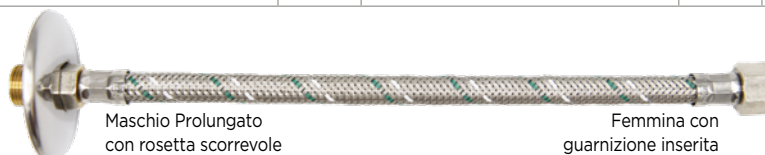

Maschio Prolungato
con rosetta scorrevole

Femmina con
guarnizione inserita

● G 1/2

CODICE	RACCORDI	DN	LUNGHEZZA mm			
CHQDDS0200DMR	Maschio Prolungato con rosetta scorrevole G 1/2 Femmina con guarnizione inserita G 1/2	8	200	83	-	25
CHQDDS0250DMR			250	89	-	25
CHQDDS0300DMR			300	95	-	25
CHQDDS0350DMR			350	102	-	25
CHQDDS0400DMS			400	108	10	-
CHQDDS0500DMS			500	121	10	-
CHQDDS0600DMS			600	133	10	-
CHQDDS0800DMS			800	159	10	-
CHQDDS1000DMS			1000	184	10	-



DN
8



Max temperatura
70 °C



Max pressione
10 bar



Portata a 3 bar
28 l/min



Raggio min. di curvatura
48 mm



Tubo interno
SILICONE



Trezza
INOX AISI 304



Raccordi
CW617N



Istruzioni
Pag. 438



TUBI FLESSIBILI BAGNO

1.5 / OMNYFLEX 10

OMNYFLEX 10

APPLICAZIONI GENERICHE



È la soluzione ideale per l'allacciamento dalla rete idrica a scaldabagni e caldaie. Il diametro maggiore permette portate più elevate e assicura controllo della pressione.

CARATTERISTICHE TECNICHE



DN

10



Max temperatura

70 °C



Max pressione

10 bar



Portata a 3 bar

46 l/min



Raggio min.
di curvatura
56 mm



Tubo interno

EPDM



Treccia

INOX AISI
304



Raccordi

CW617N

CAMPI DI APPLICAZIONE



scaldabagni



caldaie



installazioni generiche

TUBO INTERNO



EPDM

La gomma EPDM perossidica è il materiale più utilizzato per la realizzazione del tubo interno.

Con diverse composizioni chimiche, ha proprietà igieniche e meccaniche di alto livello, unitamente ad un'assoluta resistenza all'ossidazione, agli agenti atmosferici ed alle alte temperature.

TIPOLOGIA DI RACCORDI

Maschio

G 3/8
G 1/2



Maschio Prolungato

G 3/8 - 26 mm
G 1/2 - 28 mm



Femmina con guarnizione inserita

G 3/8
G 1/2



Raccordo a Stringere

G 3/8 Ø 10 mm



Maschio Girevole

G 1/2



Maschio Prolungato con rosetta scorrevole

G 3/8 - 26 mm
G 1/2 - 28 mm



CERTIFICAZIONI

EN 13618

UE



Istruzioni
Pag. 438

Per informazioni sulle specifiche tecniche e sui prodotti certificati si prega di rivolgersi ai nostri uffici o visitare il sito web degli enti di certificazione corrispondenti.

OF 1001

● G 3/8



● G 3/8

Maschio

Femmina con guarnizione inserita

CODICE	RACCORDI	DN	LUNGHEZZA mm			
FGACFS0200LAL	Maschio G 3/8 Femmina con guarnizione inserita G 3/8	10	200	70	-	25
FGACFS0250LAL			250	78	-	25
FGACFS0300LAL			300	86	-	25
FGACFS0350LAL			350	93	-	25
FGACFS0400LAE			400	101	10	-
FGACFS0500LAE			500	116	10	-
FGACFS0600LAE			600	131	10	-
FGACFS0800LAE			800	161	10	-
FGACFS1000LAE			1000	191	10	-

OF 1002

● G 3/8



● G 1/2

Maschio

Femmina con guarnizione inserita

CODICE	RACCORDI	DN	LUNGHEZZA mm			
FGACDS0200LAL	Maschio G 3/8 Femmina con guarnizione inserita G 1/2	10	200	74	-	25
FGACDS0250LAL			250	82	-	25
FGACDS0300LAL			300	90	-	25
FGACDS0350LAL			350	97	-	25
FGACDS0400LAE			400	105	10	-
FGACDS0500LAE			500	120	10	-
FGACDS0600LAE			600	135	10	-
FGACDS0800LAE			800	165	10	-
FGACDS1000LAE			1000	195	10	-

OF 1003

● G 1/2



● G 3/8

Maschio

Femmina con guarnizione inserita

CODICE	RACCORDI	DN	LUNGHEZZA mm			
FGAAVS0200LAL	Maschio G 1/2 Femmina con guarnizione inserita G 3/8	10	200	82	-	25
FGAAVS0250LAL			250	89	-	25
FGAAVS0300LAL			300	97	-	25
FGAAVS0350LAL			350	104	-	25
FGAAVS0400LAE			400	112	10	-
FGAAVS0500LAE			500	127	10	-
FGAAVS0600LAE			600	142	10	-
FGAAVS0800LAE			800	172	10	-
FGAAVS1000LAE			1000	203	10	-

OF 1004

● G 1/2



● G 1/2

Maschio

Femmina con guarnizione inserita

CODICE	RACCORDI	DN	LUNGHEZZA mm			
FGAASS0200LAL	Maschio G 1/2 Femmina con guarnizione inserita G 1/2	10	200	86	-	25
FGAASS0250LAL			250	94	-	25
FGAASS0300LAL			300	101	-	25
FGAASS0350LAL			350	109	-	25
FGAASS0400LAE			400	116	10	-
FGAASS0500LAE			500	131	10	-
FGAASS0600LAE			600	147	10	-
FGAASS0800LAE			800	178	10	-
FGAASS1000LAE			1000	207	10	-



DN
10



Max temperatura
70 °C



Max pressione
10 bar



Portata a 3 bar
46 l/min



Raggio min. di curvatura
56 mm



Tubo interno
EPDM



Trecia
INOX AISI 304



Raccordi
CW617N



Istruzioni
Pag. 438

OF 1005

● G 3/8



● G 3/8

Femmina con guarnizione inserita

Femmina con guarnizione inserita

CODICE	RACCORDI	DN	LUNGHEZZA mm				
FGAGUS0200LAL	Femmina con guarnizione inserita G 3/8	10	200	74	-	25	
FGAGUS0250LAL			250	81	-	25	
FGAGUS0300LAL			300	89	-	25	
FGAGUS0350LAL			350	96	-	25	
FGAGUS0400LAE			Femmina con guarnizione inserita G 3/8	400	104	10	-
FGAGUS0500LAE				500	119	10	-
FGAGUS0600LAE				600	134	10	-
FGAGUS0800LAE				800	164	10	-
FGAGUS1000LAE				1000	195	10	-

OF 1006

● G 1/2



● G 3/8

Femmina con guarnizione inserita

Femmina con guarnizione inserita

CODICE	RACCORDI	DN	LUNGHEZZA mm			
FGAGNS0200LAL	Femmina con guarnizione inserita G 1/2	10	200	78	-	25
FGAGNS0250LAL			250	85	-	25
FGAGNS0300LAL			300	93	-	25
FGAGNS0350LAL			350	100	-	25
FGAGNS0400LAE			Femmina con guarnizione inserita G 3/8	400	108	10
FGAGNS0500LAE	500	123		10	-	
FGAGNS0600LAE	600	138		10	-	
FGAGNS0800LAE	800	168		10	-	
FGAGNS1000LAE	1000	199		10	-	

OF 1007

● G 1/2



● G 1/2

Femmina con guarnizione inserita

Femmina con guarnizione inserita

CODICE	RACCORDI	DN	LUNGHEZZA mm				
FGAGKS0200LAL	Femmina con guarnizione inserita G 1/2	10	200	82	-	25	
FGAGKS0250LAL			250	89	-	25	
FGAGKS0300LAL			300	97	-	25	
FGAGKS0350LAL			350	105	-	25	
FGAGKS0400LAE			Femmina con guarnizione inserita G 1/2	400	112	10	-
FGAGKS0500LAE				500	127	10	-
FGAGKS0600LAE				600	142	10	-
FGAGKS0800LAE				800	172	10	-
FGAGKS1000LAE				1000	203	10	-



DN
10



Max temperatura
70 °C



Max pressione
10 bar



Portata a 3 bar
46 l/min



Raggio min. di curvatura
56 mm



Tubo interno
EPDM



Trezza
INOX AISI 304



Raccordi
CW617N



Istruzioni
Pag. 438

OF 1008

● G 1/2



● G 3/8

Maschio Girevole

Femmina con guarnizione inserita

CODICE	RACCORDI	DN	LUNGHEZZA mm			
FGAD8S0200LAL	Maschio Girevole G 1/2 Femmina con guarnizione inserita G 3/8	10	200	96	-	25
FGAD8S0250LAL			250	104	-	25
FGAD8S0300LAL			300	111	-	25
FGAD8S0350LAL			350	119	-	25
FGAD8S0400LAE			400	127	10	-
FGAD8S0500LAE			500	142	10	-
FGAD8S0600LAE			600	157	10	-
FGAD8S0800LAE			800	187	10	-
FGAD8S1000LAE			1000	217	10	-

OF 1009

● G 1/2



● G 1/2

Maschio Girevole

Femmina con guarnizione inserita

CODICE	RACCORDI	DN	LUNGHEZZA mm			
FGACMS0200LAL	Maschio Girevole G 1/2 Femmina con guarnizione inserita G 1/2	10	200	100	-	25
FGACMS0250LAL			250	108	-	25
FGACMS0300LAL			300	115	-	25
FGACMS0350LAL			350	123	-	25
FGACMS0400LAE			400	131	10	-
FGACMS0500LAE			500	146	10	-
FGACMS0600LAE			600	161	10	-
FGACMS0800LAE			800	191	10	-
FGACMS1000LAE			1000	221	10	-

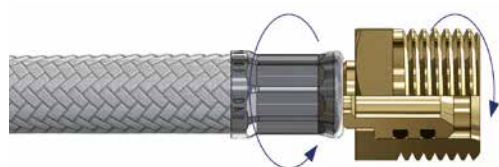

MASCHIO GIREVOLE

Il maschio girevole permette al tubo flessibile di ruotare liberamente dopo l'installazione.

Elimina i problemi di torsione e permette montaggi e destinazioni d'uso particolari.



DN
10



Max temperatura
70 °C



Max pressione
10 bar



Portata a 3 bar
46 l/min



Raggio min. di curvatura
56 mm



Tubo interno
EPDM



Treccia
INOX AISI 304



Raccordi
CW617N



Istruzioni
Pag. 438

OF 1010

● G 3/8



● G 3/8

Maschio Prolungato

Femmina con guarnizione inserita

CODICE	RACCORDI	DN	LUNGHEZZA mm			
FGADJS0200LAL	Maschio Prolungato G 3/8 Femmina con guarnizione inserita G 3/8	10	200	81	-	25
FGADJS0250LAL			250	89	-	25
FGADJS0300LAL			300	97	-	25
FGADJS0350LAL			350	104	-	25
FGADJS0400LAE			400	112	10	-
FGADJS0500LAE			500	127	10	-
FGADJS0600LAE			600	142	10	-
FGADJS0800LAE			800	172	10	-
FGADJS1000LAE			1000	202	10	-

OF 1011

● G 3/8



● G 1/2

Maschio Prolungato

Femmina con guarnizione inserita

CODICE	RACCORDI	DN	LUNGHEZZA mm			
FGADHS0200LAL	Maschio Prolungato G 3/8 Femmina con guarnizione inserita G 1/2	10	200	85	-	25
FGADHS0250LAL			250	93	-	25
FGADHS0300LAL			300	101	-	25
FGADHS0350LAL			350	108	-	25
FGADHS0400LAE			400	116	10	-
FGADHS0500LAE			500	131	10	-
FGADHS0600LAE			600	146	10	-
FGADHS0800LAE			800	176	10	-
FGADHS1000LAE			1000	206	10	-

OF 1012

● G 1/2



● G 3/8

Maschio Prolungato

Femmina con guarnizione inserita

CODICE	RACCORDI	DN	LUNGHEZZA mm			
FGADES0200LAL	Maschio Prolungato G 1/2 Femmina con guarnizione inserita G 3/8	10	200	103	-	25
FGADES0250LAL			250	111	-	25
FGADES0300LAL			300	118	-	25
FGADES0350LAL			350	126	-	25
FGADES0400LAE			400	133	10	-
FGADES0500LAE			500	148	10	-
FGADES0600LAE			600	163	10	-
FGADES0800LAE			800	194	10	-
FGADES1000LAE			1000	224	10	-

OF 1013

● G 1/2



● G 1/2

Maschio Prolungato

Femmina con guarnizione inserita

CODICE	RACCORDI	DN	LUNGHEZZA mm			
FGADDS0200LAL	Maschio Prolungato G 1/2 Femmina con guarnizione inserita G 1/2	10	200	107	-	25
FGADDS0250LAL			250	115	-	25
FGADDS0300LAL			300	122	-	25
FGADDS0350LAL			350	130	-	25
FGADDS0400LAE			400	137	10	-
FGADDS0500LAE			500	152	10	-
FGADDS0600LAE			600	167	10	-
FGADDS0800LAE			800	198	10	-
FGADDS1000LAE			1000	228	10	-



DN
10



Max temperatura
70 °C



Max pressione
10 bar



Portata a 3 bar
46 l/min



Raggio min. di curvatura
56 mm



Tubo interno
EPDM



Trezza
INOX AISI 304



Raccordi
CW617N



Istruzioni
Pag. 438

OF 1014

● G 3/8



Maschio Prolungato
con rosetta scorrevole

Femmina con
guarnizione inserita

● G 3/8

CODICE	RACCORDI	DN	LUNGHEZZA mm			
FGADJS0200LAR	Maschio Prolungato con rosetta scorrevole G 3/8 Femmina con guarnizione inserita G 3/8	10	200	90	-	25
FGADJS0250LAR			250	98	-	25
FGADJS0300LAR			300	106	-	25
FGADJS0350LAR			350	113	-	25
FGADJS0400LAS			400	121	10	-
FGADJS0500LAS			500	136	10	-
FGADJS0600LAS			600	151	10	-
FGADJS0800LAS			800	181	10	-
FGADJS1000LAS			1000	211	10	-

OF 1015

● G 3/8

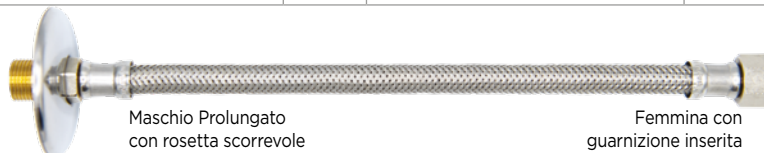

Maschio Prolungato
con rosetta scorrevole

Femmina con
guarnizione inserita

● G 1/2

CODICE	RACCORDI	DN	LUNGHEZZA mm			
FGADHS0200LAR	Maschio Prolungato con rosetta scorrevole G 3/8 Femmina con guarnizione inserita G 1/2	10	200	94	-	25
FGADHS0250LAR			250	102	-	25
FGADHS0300LAR			300	110	-	25
FGADHS0350LAR			350	117	-	25
FGADHS0400LAS			400	125	10	-
FGADHS0500LAS			500	140	10	-
FGADHS0600LAS			600	155	10	-
FGADHS0800LAS			800	185	10	-
FGADHS1000LAS			1000	215	10	-

OF 1016

● G 1/2

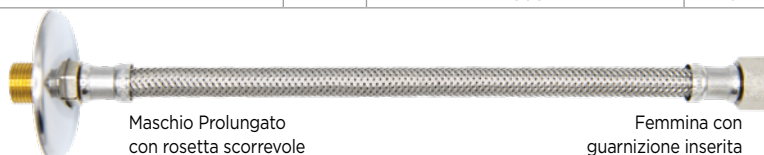

Maschio Prolungato
con rosetta scorrevole

Femmina con
guarnizione inserita

● G 3/8

CODICE	RACCORDI	DN	LUNGHEZZA mm			
FGADES0200LAR	Maschio Prolungato con rosetta scorrevole G 1/2 Femmina con guarnizione inserita G 3/8	10	200	111	-	25
FGADES0250LAR			250	119	-	25
FGADES0300LAR			300	126	-	25
FGADES0350LAR			350	134	-	25
FGADES0400LAS			400	141	10	-
FGADES0500LAS			500	156	10	-
FGADES0600LAS			600	171	10	-
FGADES0800LAS			800	202	10	-
FGADES1000LAS			1000	232	10	-

OF 1017

● G 1/2

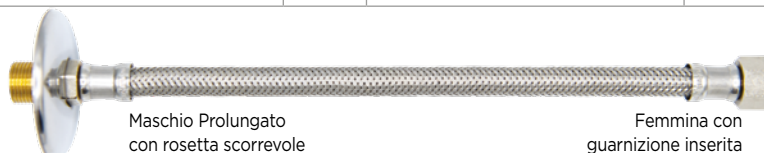

Maschio Prolungato
con rosetta scorrevole

Femmina con
guarnizione inserita

● G 1/2

CODICE	RACCORDI	DN	LUNGHEZZA mm			
FGADDS0200LAR	Maschio Prolungato con rosetta scorrevole G 1/2 Femmina con guarnizione inserita G 1/2	10	200	115	-	25
FGADDS0250LAR			250	123	-	25
FGADDS0300LAR			300	130	-	25
FGADDS0350LAR			350	138	-	25
FGADDS0400LAS			400	145	10	-
FGADDS0500LAS			500	160	10	-
FGADDS0600LAS			600	175	10	-
FGADDS0800LAS			800	206	10	-
FGADDS1000LAS			1000	236	10	-



DN
10



Max temperatura
70 °C



Max pressione
10 bar



Portata a 3 bar
46 l/min



Raggio min. di curvatura
56 mm



Tubo interno
EPDM



Treccia
INOX AISI 304



Raccordi
CW617N



Istruzioni
Pag. 438

OF 1018

● G 3/8



Maschio

Raccordo a stringere

● G 3/8 Ø 10 mm

CODICE	RACCORDI	DN	LUNGHEZZA mm			
FGAQMS0200LAL	Maschio G 3/8 Raccordo a stringere G 3/8 Ø 10 mm	10	200	85	-	25
FGAQMS0250LAL			250	92	-	25
FGAQMS0300LAL			300	100	-	25
FGAQMS0350LAL			350	108	-	25
FGAQMS0400LAE			400	115	10	-
FGAQMS0500LAE			500	130	10	-
FGAQMS0600LAE			600	145	10	-
FGAQMS0800LAE			800	176	10	-
FGAQMS1000LAE			1000	206	10	-

OF 1019

● G 1/2



Maschio

Raccordo a stringere

● G 3/8 Ø 10 mm

CODICE	RACCORDI	DN	LUNGHEZZA mm			
FGAQES0200LAL	Maschio G 1/2 Raccordo a stringere G 3/8 Ø 10 mm	10	200	96	-	25
FGAQES0250LAL			250	104	-	25
FGAQES0300LAL			300	111	-	25
FGAQES0350LAL			350	119	-	25
FGAQES0400LAE			400	126	10	-
FGAQES0500LAE			500	142	10	-
FGAQES0600LAE			600	157	10	-
FGAQES0800LAE			800	187	10	-
FGAQES1000LAE			1000	217	10	-

OF 1020

● G 3/8



Femmina con guarnizione inserita

Raccordo a stringere

● G 3/8 Ø 10 mm

CODICE	RACCORDI	DN	LUNGHEZZA mm			
FGANWS0200LAL	Femmina con guarnizione inserita G 3/8 Raccordo a stringere G 3/8 Ø 10 mm	10	200	88	-	25
FGANWS0250LAL			250	96	-	25
FGANWS0300LAL			300	103	-	25
FGANWS0350LAL			350	111	-	25
FGANWS0400LAE			400	118	10	-
FGANWS0500LAE			500	134	10	-
FGANWS0600LAE			600	149	10	-
FGANWS0800LAE			800	179	10	-
FGANWS1000LAE			1000	209	10	-

OF 1021

● G 1/2



Femmina con guarnizione inserita

Raccordo a stringere

● G 3/8 Ø 10 mm

CODICE	RACCORDI	DN	LUNGHEZZA mm			
FGANVS0200LAL	Femmina con guarnizione inserita G 1/2 Raccordo a stringere G 3/8 Ø 10 mm	10	200	92	-	25
FGANVS0250LAL			250	100	-	25
FGANVS0300LAL			300	107	-	25
FGANVS0350LAL			350	115	-	25
FGANVS0400LAE			400	122	10	-
FGANVS0500LAE			500	138	10	-
FGANVS0600LAE			600	153	10	-
FGANVS0800LAE			800	183	10	-
FGANVS1000LAE			1000	213	10	-



DN
10



Max temperatura
70 °C



Max pressione
10 bar



Portata a 3 bar
46 l/min



Raggio min. di curvatura
56 mm



Tubo interno
EPDM



Trezza
INOX AISI 304



Raccordi
CW617N



Istruzioni
Pag. 438

OF 1022

● G 3/8



● G 3/8 Ø 10 mm

Maschio Prolungato

Raccordo a stringere

CODICE	RACCORDI	DN	LUNGHEZZA mm			
FGAQQS0200LAL	Maschio Prolungato G 3/8 Raccordo a stringere G 3/8 Ø 10 mm	10	200	96	-	25
FGAQQS0250LAL			250	104	-	25
FGAQQS0300LAL			300	111	-	25
FGAQQS0350LAL			350	119	-	25
FGAQQS0400LAE			400	126	10	-
FGAQQS0500LAE			500	141	10	-
FGAQQS0600LAE			600	156	10	-
FGAQQS0800LAE			800	187	10	-
FGAQQS1000LAE			1000	217	10	-

OF 1023

● G 1/2



● G 3/8 Ø 10 mm

Maschio Prolungato

Raccordo a stringere

CODICE	RACCORDI	DN	LUNGHEZZA mm			
FGAQPS0200LAL	Maschio Prolungato G 1/2 Raccordo a stringere G 3/8 Ø 10 mm	10	200	118	-	25
FGAQPS0250LAL			250	125	-	25
FGAQPS0300LAL			300	133	-	25
FGAQPS0350LAL			350	140	-	25
FGAQPS0400LAE			400	148	10	-
FGAQPS0500LAE			500	163	10	-
FGAQPS0600LAE			600	178	10	-
FGAQPS0800LAE			800	208	10	-
FGAQPS1000LAE			1000	238	10	-

OF 1024

● G 3/8



● G 3/8 Ø 10 mm

Maschio Prolungato
con rosetta scorrevole

Raccordo
a stringere

CODICE	RACCORDI	DN	LUNGHEZZA mm			
FGAQQS0200LAR	Maschio Prolungato con rosetta scorrevole G 3/8 Raccordo a stringere G 3/8 Ø 10 mm	10	200	105	-	25
FGAQQS0250LAR			250	113	-	25
FGAQQS0300LAR			300	120	-	25
FGAQQS0350LAR			350	128	-	25
FGAQQS0400LAS			400	135	10	-
FGAQQS0500LAS			500	150	10	-
FGAQQS0600LAS			600	165	10	-
FGAQQS0800LAS			800	196	10	-
FGAQQS1000LAS			1000	226	10	-

OF 1025

● G 1/2



● G 3/8 Ø 10 mm

Maschio Prolungato
con rosetta scorrevole

Raccordo
a stringere

CODICE	RACCORDI	DN	LUNGHEZZA mm			
FGAQPS0200LAR	Maschio Prolungato con rosetta scorrevole G 1/2 Raccordo a stringere G 3/8 Ø 10 mm	10	200	126	-	25
FGAQPS0250LAR			250	133	-	25
FGAQPS0300LAR			300	141	-	25
FGAQPS0350LAR			350	148	-	25
FGAQPS0400LAS			400	156	10	-
FGAQPS0500LAS			500	171	10	-
FGAQPS0600LAS			600	186	10	-
FGAQPS0800LAS			800	216	10	-
FGAQPS1000LAS			1000	246	10	-



DN
10



Max temperatura
70 °C



Max pressione
10 bar



Portata a 3 bar
46 l/min



Raggio min. di curvatura
56 mm



Tubo interno
EPDM



Treccia
INOX AISI 304



Raccordi
CW617N



Istruzioni
Pag. 438



TUBI FLESSIBILI BAGNO

1.6 / W-FLEX

W-FLEX

CABINE DOCCIA E IDROMASSAGGIO



Dotati di treccia esterna in acciaio inossidabile, raccordi di ottone e bussole in acciaio inossidabile, sono utilizzati prevalentemente per il collegamento tra la rete idrica e pareti

doccia attrezzate o vasche idromassaggio. Ideali per il montaggio da parte dell'installatore grazie al maschio girevole in dotazione.

CARATTERISTICHE TECNICHE



DN

8
10



Max temperatura

70 °C



Max pressione

10 bar



Portata a 3 bar

28 l/min
46 l/min



Raggio min.
di curvatura
48 mm
56 mm



Tubo interno

EPDM



Treccia

INOX AISI
304



Raccordi

CW617N

CAMPI DI APPLICAZIONE



cabine doccia



vasche idromassaggio

TUBO INTERNO



EPDM

La gomma EPDM perossidica è il materiale più utilizzato per la realizzazione del tubo interno.

Con diverse composizioni chimiche, ha proprietà igieniche e meccaniche di alto livello, unitamente ad un'assoluta resistenza all'ossidazione, agli agenti atmosferici ed alle alte temperature.

TIPOLOGIA DI RACCORDI

Maschio
Girevole
G 1/2



Femmina con
guarnizione
inserita
G 1/2



Femmina Curva
con guarnizione
inserita
G 1/2



CERTIFICAZIONI

EN 13618
UE



Istruzioni
Pag. 438

Per informazioni sulle specifiche tecniche e sui prodotti certificati si prega di rivolgersi ai nostri uffici o visitare il sito web degli enti di certificazione corrispondenti.

WF 801

● G 1/2



● G 1/2

Maschio Girevole

Femmina con guarnizione inserita

CODICE	RACCORDI	DN	LUNGHEZZA mm			
CGGCMS0600LAE	Maschio Girevole G 1/2	8	600	206	10	-
CGGCMS0800LAE			800	249	10	-
CGGCMS1000LAE	Femmina con guarnizione inserita G 1/2	8	1000	292	10	-
CGGCMS1200LAN			1200	335	-	10
CGGCMS1500LAN			1500	399	-	10

WF 1001

● G 1/2



● G 1/2

Maschio Girevole

Femmina con guarnizione inserita

CODICE	RACCORDI	DN	LUNGHEZZA mm			
FGGCMS0600LAE	Maschio Girevole G 1/2	10	600	160	10	-
FGGCMS0800LAE			800	190	10	-
FGGCMS1000LAE	Femmina con guarnizione inserita G 1/2	10	1000	219	10	-
FGGCMS1200LAN			1200	248	-	10
FGGCMS1500LAN			1500	293	-	10

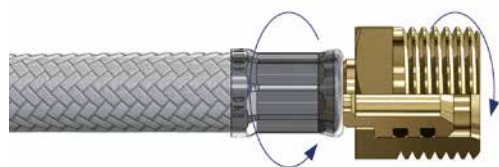

MASCHIO GIREVOLE

Il maschio girevole permette al tubo flessibile di ruotare liberamente dopo l'installazione.

Elimina i problemi di torsione e permette montaggi e destinazioni d'uso particolari.



DN
8
10



Max temperatura
70 °C



Max pressione
10 bar



Portata a 3 bar
28 l/min
46 l/min



Raggio min. di curvatura
48 mm
56 mm



Tubo interno
EPDM



Treccia
INOX AISI 304



Raccordi
CW617N



Istruzioni
Pag. 438

WF 802

● G 1/2



● G 1/2

Maschio Girevole

Femmina Curva con guarnizione inserita

CODICE	RACCORDI	DN	LUNGHEZZA mm			
CGGESS0600LAE	Maschio Girevole G 1/2	8	600	207	10	-
CGGESS0800LAE			800	250	10	-
CGGESS1000LAE	Femmina con guarnizione inserita G 1/2		1000	293	10	-
CGGESS1200LAN			1200	336	-	10
CGGESS1500LAN			1500	400	-	10

WF 1002

● G 1/2



● G 1/2

Maschio Girevole

Femmina Curva con guarnizione inserita

CODICE	RACCORDI	DN	LUNGHEZZA mm			
FGGESS0600LAE	Maschio Girevole G 1/2	10	600	178	10	-
FGGESS0800LAE			800	207	10	-
FGGESS1000LAE	Femmina con guarnizione inserita G 1/2		1000	237	10	-
FGGESS1200LAN			1200	266	-	10
FGGESS1500LAN			1500	310	-	10

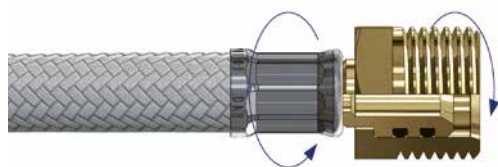

MASCHIO GIREVOLE

Il maschio girevole permette al tubo flessibile di ruotare liberamente dopo l'installazione.

Elimina i problemi di torsione e permette montaggi e destinazioni d'uso particolari.



DN
8
10



Max temperatura
70 °C



Max pressione
10 bar



Portata a 3 bar
28 l/min
46 l/min



Raggio min. di curvatura
48 mm
56 mm



Tubo interno
EPDM



Treccia
INOX AISI 304



Raccordi
CW617N



Istruzioni
Pag. 438



TUBI FLESSIBILI BAGNO

1.7 / SHOWER FLEX

SHOWER FLEX

FLESSIBILE PER DOCCIA



Il tubo in PVC ideale per ogni doccia, esteticamente perfetto e con una ghiera girevole per facilitarne l'utilizzo.

CARATTERISTICHE TECNICHE



DN

10



Max temperatura

60 °C



Max pressione

5 bar



Portata a 3 bar

46 l/min



Raggio min.
di curvatura
56 mm



Tubo interno

PVC



Treccia

-



Raccordi

CW617N

CAMPI DI APPLICAZIONE



cabine doccia

TIPOLOGIA DI RACCORDI

**Ghiera Conica
girevole**
G 1/2



**Ghiera
Zigrinata**
G 1/2



**Ghiera
Conica**
G 1/2



Istruzioni
Pag. 438

Per informazioni sulle specifiche tecniche e sui prodotti certificati si prega di rivolgersi ai nostri uffici o visitare il sito web degli enti di certificazione corrispondenti.

SF 8506

● G 1/2 Ghiera Conica girevole  Ghiera Zigrinata ● G 1/2

CODICE	RACCORDI	DN	MATERIALE	LUNGHEZZA mm			
85061500	Ghiera Conica girevole G 1/2	10	PVC cromato	1500	206	-	10
85062000	Ghiera Zigrinata G 1/2			2000	249	-	10

SF 8508

● G 1/2 Ghiera Conica girevole  Ghiera Zigrinata ● G 1/2

CODICE	RACCORDI	DN	MATERIALE	LUNGHEZZA mm			
85081500	Ghiera Conica girevole G 1/2	10	PVC classic	1500	206	-	10
85082000	Ghiera Zigrinata G 1/2			2000	249	-	10

SF 8507

● G 1/2 Ghiera Conica girevole  Ghiera Conica ● G 1/2

CODICE	RACCORDI	DN	MATERIALE	LUNGHEZZA mm			
85071500	Ghiera Conica girevole G 1/2	10	PVC cromato	1500	296	-	10
85072000	Ghiera Conica G 1/2			2000	339	-	10



DN
10



Max temperatura
60 °C



Max pressione
5 bar



Portata a 3 bar
46 l/min



Raggio min. di curvatura
56 mm



Tubo interno
PVC



Treccia
-



Raccordi
CW617N



Istruzioni
Pag. 438



A series of horizontal lines for writing or drawing.



TUBI FLESSIBILI BAGNO

1.8 / OMNYFLEX 13

OMNYFLEX 13

APPLICAZIONI GENERICHE



Il tubo tradizionale e versatile con interno in EPDM per applicazioni sanitarie che richiedono una portata maggiore.

CARATTERISTICHE TECNICHE



DN

13



Max temperatura

70 °C



Max pressione

10 bar



Portata a 3 bar

74 l/min



Raggio min. di curvatura
72 mm



Tubo interno

EPDM



Treccia

INOX AISI 304



Raccordi

CW617N

CAMPI DI APPLICAZIONE



scaldabagni



cabine doccia



vasche idromassaggio



fan coil



installazioni generiche

TUBO INTERNO



EPDM

La gomma EPDM perossidica è il materiale più utilizzato per la realizzazione del tubo interno.

Con diverse composizioni chimiche, ha proprietà igieniche e meccaniche di alto livello, unitamente ad un'assoluta resistenza all'ossidazione, agli agenti atmosferici ed alle alte temperature.

TIPOLOGIA DI RACCORDI

Maschio

G 1/2
G 3/4



Maschio Prolungato

G 1/2 - 28 mm



Femmina con guarnizione inserita

G 1/2
G 3/4



Femmina Curva con guarnizione inserita

G 1/2
G 3/4



Maschio Prolungato con rosetta scorrevole

G 1/2 - 28 mm



CERTIFICAZIONI

EN 13618

UE



Istruzioni
Pag. 438

Per informazioni sulle specifiche tecniche e sui prodotti certificati si prega di rivolgersi ai nostri uffici o visitare il sito web degli enti di certificazione corrispondenti.

OF 1301

● G 1/2



● G 1/2

Maschio

Femmina con guarnizione inserita

CODICE	RACCORDI	DN	LUNGHEZZA mm			
MGAASS0200LAL	Maschio G 1/2 Femmina con guarnizione inserita G 1/2	13	200	115	-	25
MGAASS0250LAL			250	128	-	25
MGAASS0300LAL			300	141	-	25
MGAASS0350LAL			350	153	-	25
MGAASS0400LAE			400	166	10	-
MGAASS0500LAE			500	191	10	-
MGAASS0600LAE			600	216	10	-
MGAASS0800LAE			800	266	10	-
MGAASS1000LAE			1000	317	10	-

OF 1302

● G 1/2



● G 3/4

Maschio

Femmina con guarnizione inserita

CODICE	RACCORDI	DN	LUNGHEZZA mm			
MGA AUS0200LAL	Maschio G 1/2 Femmina con guarnizione inserita G 3/4	13	200	133	-	20
MGA AUS0250LAL			250	145	-	20
MGA AUS0300LAL			300	158	-	20
MGA AUS0350LAL			350	171	-	20
MGA AUS0400LAE			400	183	10	-
MGA AUS0500LAE			500	208	10	-
MGA AUS0600LAE			600	233	10	-
MGA AUS0800LAE			800	284	10	-
MGA AUS1000LAE			1000	334	10	-

OF 1303

● G 3/4



● G 1/2

Maschio

Femmina con guarnizione inserita

CODICE	RACCORDI	DN	LUNGHEZZA mm			
MGACBS0200LAL	Maschio G 3/4 Femmina con guarnizione inserita G 1/2	13	200	132	-	20
MGACBS0250LAL			250	145	-	20
MGACBS0300LAL			300	157	-	20
MGACBS0350LAL			350	170	-	20
MGACBS0400LAE			400	183	10	-
MGACBS0500LAE			500	208	10	-
MGACBS0600LAE			600	233	10	-
MGACBS0800LAE			800	283	10	-
MGACBS1000LAE			1000	333	10	-

OF 1304

● G 3/4



● G 3/4

Maschio

Femmina con guarnizione inserita

CODICE	RACCORDI	DN	LUNGHEZZA mm			
MGA E7S0200LAL	Maschio G 3/4 Femmina con guarnizione inserita G 3/4	13	200	150	-	20
MGA E7S0250LAL			250	162	-	20
MGA E7S0300LAL			300	175	-	20
MGA E7S0350LAL			350	187	-	20
MGA E7S0400LAE			400	200	10	-
MGA E7S0500LAE			500	225	10	-
MGA E7S0600LAE			600	250	10	-
MGA E7S0800LAE			800	300	10	-
MGA E7S1000LAE			1000	351	10	-



DN
13



Max temperatura
70 °C



Max pressione
10 bar



Portata a 3 bar
74 l/min



Raggio min. di curvatura
72 mm



Tubo interno
EPDM



Treccia
INOX AISI 304



Raccordi
CW617N



Istruzioni
Pag. 438

OF 1305

● G 1/2



● G 1/2

Femmina con guarnizione inserita

Femmina con guarnizione inserita

CODICE	RACCORDI	DN	LUNGHEZZA mm			
MGAGKS0200LAL	Femmina con guarnizione inserita G 1/2	13	200	110	-	25
MGAGKS0250LAL			250	123	-	25
MGAGKS0300LAL			300	136	-	25
MGAGKS0350LAL			350	148	-	25
MGAGKS0400LAE			400	161	10	-
MGAGKS0500LAE			500	186	10	-
MGAGKS0600LAE			600	211	10	-
MGAGKS0800LAE			800	261	10	-
MGAGKS1000LAE			1000	312	10	-

OF 1306

● G 1/2



● G 3/4

Femmina con guarnizione inserita

Femmina con guarnizione inserita

CODICE	RACCORDI	DN	LUNGHEZZA mm			
MGAGMS0200LAL	Femmina con guarnizione inserita G 1/2	13	200	134	-	20
MGAGMS0250LAL			250	146	-	20
MGAGMS0300LAL			300	159	-	20
MGAGMS0350LAL			350	171	-	20
MGAGMS0400LAE			400	184	10	-
MGAGMS0500LAE			500	209	10	-
MGAGMS0600LAE			600	234	10	-
MGAGMS0800LAE			800	285	10	-
MGAGMS1000LAE			1000	335	10	-

OF 1307

● G 3/4



● G 3/4

Femmina con guarnizione inserita

Femmina con guarnizione inserita

CODICE	RACCORDI	DN	LUNGHEZZA mm			
MGAGRS0200LAL	Femmina con guarnizione inserita G 3/4	13	200	145	-	20
MGAGRS0250LAL			250	157	-	20
MGAGRS0300LAL			300	170	-	20
MGAGRS0350LAL			350	183	-	20
MGAGRS0400LAE			400	195	10	-
MGAGRS0500LAE			500	220	10	-
MGAGRS0600LAE			600	246	10	-
MGAGRS0800LAE			800	296	10	-
MGAGRS1000LAE			1000	346	10	-



DN
13



Max temperatura
70 °C



Max pressione
10 bar



Portata a 3 bar
74 l/min



Raggio min. di curvatura
72 mm



Tubo interno
EPDM



Treccia
INOX AISI 304



Raccordi
CW617N



Istruzioni
Pag. 438

OF 1308

● G 1/2



Maschio

Femmina Curva con
guarnizione inserita

● G 1/2

CODICE	RACCORDI	DN	LUNGHEZZA mm			
MGAD3S0200LAL	Maschio G 1/2 Femmina Curva con guarnizione inserita G 1/2	13	200	129	-	20
MGAD3S0250LAL			250	141	-	20
MGAD3S0300LAL			300	154	-	20
MGAD3S0350LAL			350	167	-	20
MGAD3S0400LAE			400	179	10	-
MGAD3S0500LAE			500	204	10	-
MGAD3S0600LAE			600	230	10	-
MGAD3S0800LAE			800	280	10	-
MGAD3S1000LAE			1000	330	10	-

OF 1309

● G 1/2



Maschio

Femmina Curva con
guarnizione inserita

● G 3/4

CODICE	RACCORDI	DN	LUNGHEZZA mm			
MGAE2S0200LAL	Maschio G 1/2 Femmina Curva con guarnizione inserita G 3/4	13	200	147	-	20
MGAE2S0250LAL			250	172	-	20
MGAE2S0300LAL			300	185	-	20
MGAE2S0350LAL			350	197	-	20
MGAE2S0400LAE			400	222	10	-
MGAE2S0500LAE			500	248	10	-
MGAE2S0600LAE			600	298	10	-
MGAE2S0800LAE			800	348	10	-
MGAE2S1000LAE			1000	334	10	-

OF 1310

● G 3/4



Maschio

Femmina Curva con
guarnizione inserita

● G 3/4

CODICE	RACCORDI	DN	LUNGHEZZA mm			
MGAE1S0200LAL	Maschio G 3/4 Femmina Curva con guarnizione inserita G 3/4	13	200	158	-	20
MGAE1S0250LAL			250	171	-	20
MGAE1S0300LAL			300	183	-	20
MGAE1S0350LAL			350	196	-	20
MGAE1S0400LAE			400	208	10	-
MGAE1S0500LAE			500	233	10	-
MGAE1S0600LAE			600	258	10	-
MGAE1S0800LAE			800	308	10	-
MGAE1S1000LAE			1000	358	10	-



DN
13



Max temperatura
70 °C



Max pressione
10 bar



Portata a 3 bar
74 l/min



Raggio min. di curvatura
72 mm



Tubo interno
EPDM



Treccia
INOX AISI 304



Raccordi
CW617N



Istruzioni
Pag. 438

OF 1311

● G 1/2



● G 1/2

Maschio Prolungato

Femmina con guarnizione inserita

CODICE	RACCORDI	DN	LUNGHEZZA mm			
MGADDS0200LAL	Maschio Prolungato G 1/2 Femmina con guarnizione inserita G 1/2	13	200	135	-	25
MGADDS0250LAL			250	147	-	25
MGADDS0300LAL			300	160	-	25
MGADDS0350LAL			350	173	-	25
MGADDS0400LAE			400	185	10	-
MGADDS0500LAE			500	210	10	-
MGADDS0600LAE			600	235	10	-
MGADDS0800LAE			800	286	10	-
MGADDS1000LAE			1000	336	10	-

OF 1312

● G 1/2



● G 1/2

Maschio Prolungato
con rosetta scorrevole

Femmina con
guarnizione inserita

CODICE	RACCORDI	DN	LUNGHEZZA mm			
MGADDS0200LAR	Maschio Prolungato con rosetta scorrevole G 1/2 Femmina con guarnizione inserita G 1/2	13	200	143	-	25
MGADDS0250LAR			250	155	-	25
MGADDS0300LAR			300	168	-	25
MGADDS0350LAR			350	181	-	25
MGADDS0400LAS			400	193	10	-
MGADDS0500LAS			500	218	10	-
MGADDS0600LAS			600	243	10	-
MGADDS0800LAS			800	294	10	-
MGADDS1000LAS			1000	344	10	-



DN
13



Max temperatura
70 °C



Max pressione
10 bar



Portata a 3 bar
74 l/min



Raggio min. di curvatura
72 mm



Tubo interno
EPDM



Treccia
INOX AISI 304



Raccordi
CW617N



Istruzioni
Pag. 438



TUBI FLESSIBILI CUCINA

2.1 / K-FLEX

K-FLEX

IDEALE PER DOCCETTA CUCINA

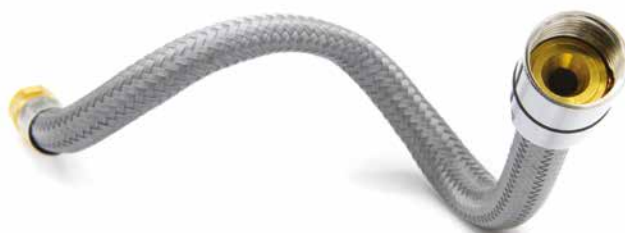

Ideale per il collegamento di doccette estraibili pull-out / pull-down utilizzabile per rubinetti da cucina. La misura standard è il DN8 con treccia in nylon PA6.6, disponibile nei

colori grigio, nero e bianco.
Raccordi in ottone e bussole in acciaio inossidabile.

CARATTERISTICHE TECNICHE



DN

8



Max temperatura

70 °C



Max pressione

10 bar



Portata a 3 bar

28 l/min

Raggio min.
di curvatura
48 mm

Tubo interno

EPDM



Treccia

NYLON PA
6.6

Raccordi

CW617N

CAMPI DI APPLICAZIONE



doccetta cucina

TUBO INTERNO



EPDM

La gomma EPDM perossidica è il materiale più utilizzato per la realizzazione del tubo interno.

Con diverse composizioni chimiche, ha proprietà igieniche e meccaniche di alto livello, unitamente ad un'assoluta resistenza all'ossidazione, agli agenti atmosferici ed alle alte temperature.

TIPOLOGIA DI RACCORDI

**Maschio
Girevole**
M 15x1



**Ghiera Conica
con o-ring e
contrappeso**
G 1/2



CERTIFICAZIONI

EN 13618
UE



Istruzioni
Pag. 438

Per informazioni sulle specifiche tecniche e sui prodotti certificati si prega di rivolgersi ai nostri uffici o visitare il sito web degli enti di certificazione corrispondenti.

KF 801



● M 15x1



● G 1/2

Maschio Girevole

Ghiera Conica con o-ring e contrappeso

CODICE	RACCORDI	DN	COLORE TRECCIA	LUNGHEZZA mm			
CPACTF1200LAG	Maschio Girevole M 15x1	8	Nylon nero	1200	365	1	50
CPACTF1500LAG	Ghiera Conica con o-ring e contrappeso G 1/2			1500	388	1	50

KF 802



● M 15x1



● G 1/2

Maschio Girevole

Ghiera Conica con o-ring e contrappeso

CODICE	RACCORDI	DN	COLORE TRECCIA	LUNGHEZZA mm			
CLACTF1200LAG	Maschio Girevole M 15x1	8	Nylon grigio	1200	365	1	50
CLACTF1500LAG	Ghiera Conica con o-ring e contrappeso G 1/2			1500	388	1	50

KF 803

● M 15x1



● G 1/2

Maschio Girevole

Ghiera Conica con o-ring e contrappeso

CODICE	RACCORDI	DN	COLORE TRECCIA	LUNGHEZZA mm			
CNACTF1200LAG	Maschio Girevole M 15x1	8	Nylon bianco	1200	365	1	50
CNACTF1500LAG	Ghiera Conica con o-ring e contrappeso G 1/2			1500	388	1	50

DN
8Max temperatura
70 °CMax pressione
10 barPortata a 3 bar
28 l/minRaggio min. di curvatura
48 mmTubo interno
EPDMTreccia
NYLON PA 6.6Raccordi
CW617NIstruzioni
Pag. 438

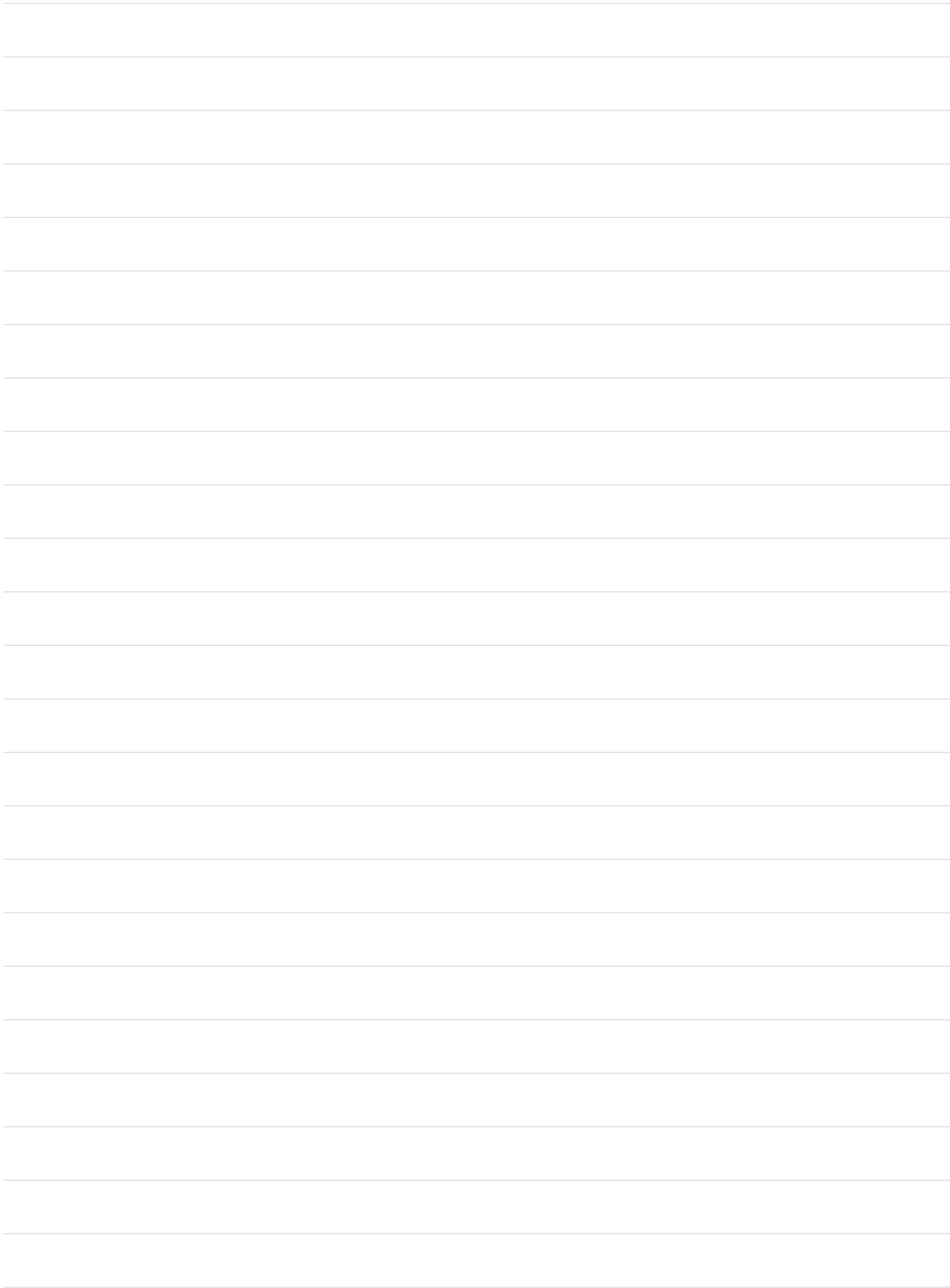



TUBI FLESSIBILI CUCINA

2.2 / FLEXY MIX

FLEXY MIX

IDEALE PER RUBINETTERIA



Con la combinazione tra la treccia in inox e il tubo interno in EPDM, permette un collegamento flessibile e semplice tra la rete di approvvigionamento idrico e rubinetti di qualsiasi

tipo. Riconosciuto per il suo alto livello di qualità, è un prodotto in conformità ai requisiti internazionali del settore.

CARATTERISTICHE TECNICHE



DN

8



Max temperatura

70 °C



Max pressione

10 bar



Portata a 3 bar

28 l/min

Raggio min.
di curvatura
48 mm

Tubo interno

EPDM



Treccia

INOX AISI
304

Raccordi

CW617N

CAMPI DI APPLICAZIONE



rubinetto tradizionale



rubinetti miscelatori

TUBO INTERNO



EPDM

La gomma EPDM perossidica è il materiale più utilizzato per la realizzazione del tubo interno.

Con diverse composizioni chimiche, ha proprietà igieniche e meccaniche di alto livello, unitamente ad un'assoluta resistenza all'ossidazione, agli agenti atmosferici ed alle alte temperature.

TIPOLOGIA DI RACCORDI

Maschio corto
M 10x1 - 18 mm



Maschio medio
M 10x1 - 46 mm



**Femmina con
guarnizione
inserita**
G 3/8
G 1/2



**Astina
con scalino**
Ø 10 mm



**Raccordo
a stringere**
G 3/8 Ø 10 mm



CERTIFICAZIONI

EN 13618
UE



Istruzioni
Pag. 438

Per informazioni sulle specifiche tecniche e sui prodotti certificati si prega di rivolgersi ai nostri uffici o visitare il sito web degli enti di certificazione corrispondenti.

FX 801

● M 10x1



● G 3/8

Maschio Corto

Femmina con guarnizione inserita

CODICE	RACCORDI	DN	LUNGHEZZA mm			
CGAKLS0200LAL	Maschio Corto M 10x1 Femmina con guarnizione inserita G 3/8	8	200	63	-	25
CGAKLS0250LAL			250	70	-	25
CGAKLS0300LAL			300	76	-	25
CGAKLS0350LAL			350	83	-	25
CGAKLS0400LAE			400	90	10	-
CGAKLS0500LAE			500	104	10	-
CGAKLS0600LAE			600	117	10	-

FX 802

● M 10x1



● G 1/2

Maschio Corto

Femmina con guarnizione inserita

CODICE	RACCORDI	DN	LUNGHEZZA mm			
CGAKJS0200LAL	Maschio Corto M 10x1 Femmina con guarnizione inserita G 1/2	8	200	78	-	25
CGAKJS0250LAL			250	85	-	25
CGAKJS0300LAL			300	92	-	25
CGAKJS0350LAL			350	99	-	25
CGAKJS0400LAE			400	106	10	-
CGAKJS0500LAE			500	119	10	-
CGAKJS0600LAE			600	133	10	-

FX 803

● M 10x1



● G 3/8

Maschio Medio

Femmina con guarnizione inserita

CODICE	RACCORDI	DN	LUNGHEZZA mm			
CGASES0200LAL	Maschio Medio M 10x1 Femmina con guarnizione inserita G 3/8	8	200	69	-	25
CGASES0250LAL			250	76	-	25
CGASES0300LAL			300	83	-	25
CGASES0350LAL			350	90	-	25
CGASES0400LAE			400	96	10	-
CGASES0500LAE			500	110	10	-
CGASES0600LAE			600	124	10	-

FX 804

● M 10x1



● G 1/2

Maschio Medio

Femmina con guarnizione inserita

CODICE	RACCORDI	DN	LUNGHEZZA mm			
CGASDS0200LAL	Maschio Medio M 10x1 Femmina con guarnizione inserita G 1/2	8	200	85	-	25
CGASDS0250LAL			250	92	-	25
CGASDS0300LAL			300	98	-	25
CGASDS0350LAL			350	105	-	25
CGASDS0400LAE			400	112	10	-
CGASDS0500LAE			500	126	10	-
CGASDS0600LAE			600	139	10	-



DN
8



Max temperatura
70 °C



Max pressione
10 bar



Portata a 3 bar
28 l/min



Raggio min. di curvatura
48 mm



Tubo interno
EPDM



Trecia
INOX AISI 304



Raccordi
CW617N



Istruzioni
Pag. 438

FX 805



● ø 10 mm



● G 3/8 Ø 10 mm

Astina con scalino

Raccordo a stringere

CODICE	RACCORDI	DN	LUNGHEZZA mm			
CGA3GS0200LAL	Astina con scalino ø 10 mm Raccordo a stringere G 3/8 ø 10 mm	8	200	75	-	25
CGA3GS0250LAL			250	82	-	25
CGA3GS0300LAL			300	89	-	25
CGA3GS0350LAL			350	96	-	25
CGA3GS0400LAE			400	102	10	-
CGA3GS0500LAE			500	116	10	-
CGA3GS0600LAE			600	130	10	-



DN

8



Max temperatura

70 °C



Max pressione

10 bar



Portata a 3 bar

28 l/min



Raggio min. di curvatura

48 mm



Tubo interno

EPDM



Trezza

INOX AISI 304



Raccordi

CW617N



Istruzioni

Pag. 438



TUBI FLESSIBILI CUCINA

2.3 / FLEXY MIX PT+

FLEXY MIX PT+

SPECIALE RUBINETTERIA IN SILICONE



L'inliner in Silicone Platinico conferisce ai tubi flessibili eccellenti proprietà igieniche nonché un'elevata resistenza alla pressione e alla temperatura è quindi particolarmente

indicato per ambienti con requisiti igienici rigorosi come per esempio strutture sanitarie.

CARATTERISTICHE TECNICHE



DN

8



Max temperatura

70 °C



Max pressione

10 bar



Portata a 3 bar

28 l/min

Raggio min.
di curvatura
48 mm

Tubo interno

SILICONE



Treccia

INOX AISI
304

Raccordi

CW617N

CAMPI DI APPLICAZIONE



rubinetto tradizionale



rubinetti miscelatori

TUBO INTERNO



SILICONE

Il silicone platinico, materiale pregiato di altissima qualità, sta raccogliendo sempre più consenso sui mercati idrosanitari internazionali.

Questa è la versione più pura disponibile sul mercato e capace di garantire la piena alimentariet  del prodotto. Alcune delle caratteristiche peculiari sono il mantenimento di un'ottima elasticit  e delle propriet  meccaniche per tutto il range di temperatura di servizio.

TIPOLOGIA DI RACCORDI

Maschio corto
M 10x1 - 18 mm



Maschio medio
M 10x1 - 46 mm



**Femmina con
guarnizione
inserita**
G 3/8
G 1/2



DM 174
Italia



EN 13618
UE



DVGW
Germania



Istruzioni
Pag. 438

Per informazioni sulle specifiche tecniche e sui prodotti certificati si prega di rivolgersi ai nostri uffici o visitare il sito web degli enti di certificazione corrispondenti.

FP 801

● M 10x1



● G 3/8

Maschio Corto

Femmina con guarnizione inserita

CODICE	RACCORDI	DN	LUNGHEZZA mm			
CHQKLS0200DML	Maschio Corto M 10x1 Femmina con guarnizione inserita G 3/8	8	200	58	-	25
CHQKLS0250DML			250	65	-	25
CHQKLS0300DML			300	71	-	25
CHQKLS0350DML			350	77	-	25
CHQKLS0400DME			400	84	10	-
CHQKLS0500DME			500	96	10	-
CHQKLS0600DME			600	109	10	-

FP 802

● M 10x1



● G 1/2

Maschio Corto

Femmina con guarnizione inserita

CODICE	RACCORDI	DN	LUNGHEZZA mm			
CHQKJS0200DML	Maschio Corto M 10x1 Femmina con guarnizione inserita G 1/2	8	200	62	-	25
CHQKJS0250DML			250	69	-	25
CHQKJS0300DML			300	75	-	25
CHQKJS0350DML			350	81	-	25
CHQKJS0400DME			400	88	10	-
CHQKJS0500DME			500	100	10	-
CHQKJS0600DME			600	113	10	-

FP 803

● M 10x1



● G 3/8

Maschio Medio

Femmina con guarnizione inserita

CODICE	RACCORDI	DN	LUNGHEZZA mm			
CHQSES0200DML	Maschio Medio M 10x1 Femmina con guarnizione inserita G 3/8	8	200	66	-	25
CHQSES0250DML			250	72	-	25
CHQSES0300DML			300	79	-	25
CHQSES0350DML			350	85	-	25
CHQSES0400DME			400	91	10	-
CHQSES0500DME			500	104	10	-
CHQSES0600DME			600	116	10	-

FP 804

● M 10x1



● G 1/2

Maschio Medio

Femmina con guarnizione inserita

CODICE	RACCORDI	DN	LUNGHEZZA mm			
CHQSDS0200DML	Maschio Medio M 10x1 Femmina con guarnizione inserita G 1/2	8	200	70	-	25
CHQSDS0250DML			250	76	-	25
CHQSDS0300DML			300	83	-	25
CHQSDS0350DML			350	89	-	25
CHQSDS0400DME			400	95	10	-
CHQSDS0500DME			500	108	10	-
CHQSDS0600DME			600	120	10	-



DN
8



Max temperatura
70 °C



Max pressione
10 bar



Portata a 3 bar
28 l/min



Raggio min. di curvatura
48 mm



Tubo interno
SILICONE



Trecia
INOX AISI 304



Raccordi
CW617N



Istruzioni
Pag. 438



TUBI FLESSIBILI CARICO ELETTRODOMESTICI

3.1 / E-FLEX INOX

E-FLEX INOX

PER ELETTRODOMESTICI



Tubo per collegamento elettrodomestici nei diametri DN8, DN10 e DN13. La treccia esterna in inox garantisce durezza e resistenza agli agenti esterni, mantenendo una discreta flessibilità nonché un'elevata resistenza alla pressione

e alla temperatura, ideale per acqua calda. Disponibile con treccia e bussola in acciaio inossidabile e raccorderia in ottone.

CARATTERISTICHE TECNICHE



DN

8
10
13



Raggio min. di curvatura
48 mm
56 mm
72 mm



Max temperatura

70 °C



Tubo interno

EPDM



Max pressione

10 bar



Treccia

INOX AISI 304



Portata a 3 bar

28 l/min
46 l/min
74 l/min



Raccordi

CW617N

CAMPI DI APPLICAZIONE



lavatrici



lavastoviglie

TUBO INTERNO



EPDM

La gomma EPDM perossidica è il materiale più utilizzato per la realizzazione del tubo interno.

Con diverse composizioni chimiche, ha proprietà igieniche e meccaniche di alto livello, unitamente ad un'assoluta resistenza all'ossidazione, agli agenti atmosferici ed alle alte temperature.

TIPOLOGIA DI RACCORDI

Femmina con guarnizione inserita
G 3/4



Femmina Curva con guarnizione inserita
G 3/4



CERTIFICAZIONI

EN 13618
UE



Istruzioni
Pag. 438

Per informazioni sulle specifiche tecniche e sui prodotti certificati si prega di rivolgersi ai nostri uffici o visitare il sito web degli enti di certificazione corrispondenti.

EFI 801

● G 3/4



● G 3/4

Femmina con guarnizione inserita

Femmina con guarnizione inserita

CODICE	RACCORDI	DN	LUNGHEZZA mm			
CGGGRS1000LAN	Femmina con guarnizione inserita G 3/4	8	1000	228	-	10
CGGGRS1500LAN			1500	290	-	10
CGGGRS2000LAN			2000	352	-	10
CGGGRS2500LAN	Femmina con guarnizione inserita G 3/4	8	2500	415	-	10
CGGGRS3000LAN			3000	477	-	10

EFI 1001

● G 3/4



● G 3/4

Femmina con guarnizione inserita

Femmina con guarnizione inserita

CODICE	RACCORDI	DN	LUNGHEZZA mm			
FGGGRS1000LAN	Femmina con guarnizione inserita G 3/4	10	1000	246	-	10
FGGGRS1500LAN			1500	319	-	10
FGGGRS2000LAN			2000	393	-	10
FGGGRS2500LAN	Femmina con guarnizione inserita G 3/4	10	2500	466	-	10
FGGGRS3000LAN			3000	539	-	10

EFI 1301

● G 3/4



● G 3/4

Femmina con guarnizione inserita

Femmina con guarnizione inserita

CODICE	RACCORDI	DN	LUNGHEZZA mm			
MGGGRS1000LAN	Femmina con guarnizione inserita G 3/4	13	1000	350	-	10
MGGGRS1500LAN			1500	472	-	10
MGGGRS2000LAN			2000	594	-	10
MGGGRS2500LAN	Femmina con guarnizione inserita G 3/4	13	2500	717	-	5
MGGGRS3000LAN			3000	839	-	5



DN
8
10
13



Max temperatura
70 °C



Max pressione
10 bar



Portata a 3 bar
28 l/min
46 l/min
74 l/min



Raggio min. di curvatura
48 mm
56 mm
72 mm



Tubo interno
EPDM



Treccia
INOX AISI 304



Raccordi
CW617N



Istruzioni
Pag. 438

EFI 802

● G 3/4



● G 3/4

Femmina con guarnizione inserita

Femmina Curva con guarnizione inserita

CODICE	RACCORDI	DN	LUNGHEZZA mm			
CGGHZS1000LAN	Femmina con guarnizione inserita G 3/4	8	1000	224	-	10
CGGHZS1500LAN			1500	286	-	10
CGGHZS2000LAN	Femmina Curva con guarnizione inserita G 3/4		2000	349	-	10
CGGHZS2500LAN			2500	411	-	10
CGGHZS3000LAN			3000	474	-	10

EFI 1002

● G 3/4



● G 3/4

Femmina con guarnizione inserita

Femmina Curva con guarnizione inserita

CODICE	RACCORDI	DN	LUNGHEZZA mm			
FGGHZS1000LAN	Femmina con guarnizione inserita G 3/4	10	1000	259	-	10
FGGHZS1500LAN			1500	332	-	10
FGGHZS2000LAN	Femmina Curva con guarnizione inserita G 3/4		2000	405	-	10
FGGHZS2500LAN			2500	479	-	10
FGGHZS3000LAN			3000	552	-	10

EFI 1302

● G 3/4



● G 3/4

Femmina con guarnizione inserita

Femmina Curva con guarnizione inserita

CODICE	RACCORDI	DN	LUNGHEZZA mm			
MGGHZS1000LAN	Femmina con guarnizione inserita G 3/4	13	1000	360	-	10
MGGHZS1500LAN			1500	482	-	10
MGGHZS2000LAN	Femmina Curva con guarnizione inserita G 3/4		2000	605	-	10
MGGHZS2500LAN			2500	727	-	5
MGGHZS3000LAN			3000	849	-	5



DN
8
10
13



Max temperatura
70 °C



Max pressione
10 bar



Portata a 3 bar
28 l/min
46 l/min
74 l/min



Raggio min. di curvatura
48 mm
56 mm
72 mm



Tubo interno
EPDM



Treccia
INOX AISI 304



Raccordi
CW617N



Istruzioni
Pag. 438



TUBI FLESSIBILI CARICO ELETTRODOMESTICI

3.2 / E-FLEX

E-FLEX

SENZA TRECCIA



Tubo flessibile in PVC rinforzato per acqua fredda, con raccordi in nylon; disponibile nelle versioni con raccordi in nylon Femmina / Femmina e Femmina / Femmina curva, sempre con guarnizione inserita.

CARATTERISTICHE TECNICHE



DN

10



Max temperatura

30 °C



Max pressione

10 bar



Portata a 3 bar

46 l/min

Raggio min.
di curvatura
60 mm

Tubo interno

PVC



Treccia

-



Raccordi

NYLON PA
6.6

CAMPI DI APPLICAZIONE



lavatrici



lavastoviglie

TIPOLOGIA DI RACCORDI

**Femmina
in nylon con
guarnizione
inserita**
G 3/4



**Femmina Curva
in nylon con
guarnizione
inserita**
G 3/4



Istruzioni
Pag. 438

Per informazioni sulle specifiche tecniche e sui prodotti certificati si prega di rivolgersi ai nostri uffici o visitare il sito web degli enti di certificazione corrispondenti.

EF 1001

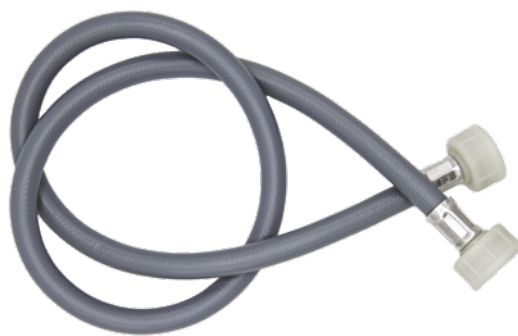

Femmina in nylon con guarnizione inserita ● G 3/4

Femmina in nylon con guarnizione inserita ● G 3/4

CODICE	RACCORDI	DN	LUNGHEZZA mm			
60108210	Femmina in nylon con guarnizione inserita G 3/4	10	1000	156	-	10
60108215			1500	218	-	10
60108220			2000	288	-	10
60108225	Femmina in nylon con guarnizione inserita G 3/4	10	2500	382	-	5
60108230			3000	420	-	5

EF 1002



Femmina in nylon con guarnizione inserita ● G 3/4

Femmina Curva in nylon con guarnizione inserita ● G 3/4

CODICE	RACCORDI	DN	LUNGHEZZA mm			
60108010	Femmina in nylon con guarnizione inserita G 3/4	10	1000	164	-	10
60108015			1500	218	-	10
60108020			2000	290	-	10
60108025	Femmina Curva in nylon con guarnizione inserita G 3/4	10	2500	388	-	5
60108030			3000	420	-	5

EF 1003

Tubi scarico in polypropilene con curva inclusa.



CODICE	RACCORDI	DN	LUNGHEZZA mm			
60001000	Tubo ø 19 x 25	10	1000	80	-	10
60001500			1500	102	-	10
60002000			2000	122	-	10
60002500	Manicotti ø 19 - ø 21	10	2500	148	-	10
60003000			3000	168	-	10

EF 1004

Guarnizione in gomma EPDM senza retino.



CODICE	RACCORDI	DN	LUNGHEZZA mm			
60120000CF	G 3/4	10	-	1	100	-



DN
10



Max temperatura
30 °C



Max pressione
10 bar



Portata a 3 bar
46 l/min



Raggio min. di curvatura
60 mm



Tubo interno
PVC



Treccia
-



Raccordi
NYLON PA 6.6



Istruzioni
Pag. 438



TUBI FLESSIBILI INDUSTRIALI

4.1 / ACFZ-S

ACFZ-S

FLESSIBILI IN ACCIAIO ZINCATO



Per applicazioni industriali dove è necessaria una portata elevata ed una temperatura massima elevata, vengono utiliz-

zati questi flessibili di grandi dimensioni, dal diametro DN15 al DN50.

CARATTERISTICHE TECNICHE



DN

15
18
25
32
40
50



Max temperatura

110 °C



Max pressione

10 bar
10 bar
10 bar
6 bar
6 bar
6 bar



Portata a 3 bar

83 l/min
200 l/min
280 l/min
490 l/min
800 l/min
1300 l/min



Raggio min. di curvatura
80 mm
104 mm
132 mm
168 mm
212 mm
275 mm



Tubo interno

EPDM



Treccia

ACCIAIO
ZINCATO



Raccordi

ACCIAIO
ZINCATO
o
CW617N
ZINCATO

CAMPI DI APPLICAZIONE



pompe



colonne montanti



impianti di riscaldamento



installazioni generiche

TUBO INTERNO



EPDM

La gomma EPDM perossidica è il materiale più utilizzato per la realizzazione del tubo interno.

Con diverse composizioni chimiche, ha proprietà igieniche e meccaniche di alto livello, unitamente ad un'assoluta resistenza all'ossidazione, agli agenti atmosferici ed alle alte temperature.

TIPOLOGIA DI RACCORDI

Maschio

G 1/2
G 3/4
G 1"
G 1" 1/4
G 1" 1/2
G 2"



Femmina

G 1/2
G 3/4
G 1"
G 1" 1/4
G 1" 1/2
G 2"



Femmina Curva

G 1/2
G 3/4
G 1"
G 1" 1/4



Istruzioni
Pag. 438

Per informazioni sulle specifiche tecniche e sui prodotti certificati si prega di rivolgersi ai nostri uffici o visitare il sito web degli enti di certificazione corrispondenti.

AC 1501

● G 1/2



Maschio

Femmina

● G 1/2

CODICE	RACCORDI	DN	LUNGHEZZA mm			
QZMANZO300LAE	Maschio G 1/2 Femmina G 1/2	15	300	187	5	-
QZMANZO400LAE			400	222	5	-
QZMANZO500LAE			500	257	5	-
QZMANZO600LAE			600	291	5	-
QZMANZO700LAE			700	326	5	-
QZMANZO800LAE			800	360	5	-
QZMANZ1000LAE			1000	430	5	-

AC 1801

● G 3/4



Maschio

Femmina

● G 3/4

CODICE	RACCORDI	DN	LUNGHEZZA mm			
SZMTG0300LAE	Maschio G 3/4 Femmina G 3/4	18	300	260	5	-
SZMTG0400LAE			400	312	5	-
SZMTG0500LAE			500	362	5	-
SZMTG0600LAE			600	413	5	-
SZMTG0700LAE			700	464	5	-
SZMTG0800LAE			800	515	5	-
SZMTG1000LAE			1000	617	5	-

AC 1802

● G 1"



Maschio

Femmina

● G 1"

CODICE	RACCORDI	DN	LUNGHEZZA mm			
SZMABG0300LAE	Maschio G 1" Femmina G 1"	18	300	321	5	-
SZMABG0400LAE			400	371	5	-
SZMABG0500LAE			500	422	5	-
SZMABG0600LAE			600	473	5	-
SZMABG0700LAE			700	524	5	-
SZMABG0800LAE			800	575	5	-
SZMABG1000LAE			1000	677	5	-

AC 2501

● G 1"



Maschio

Femmina

● G 1"

CODICE	RACCORDI	DN	LUNGHEZZA mm			
TZMABG0300LAE	Maschio G 1" Femmina G 1"	25	300	389	5	-
TZMABG0400LAE			400	459	5	-
TZMABG0500LAE			500	530	5	-
TZMABG0600LAE			600	601	5	-
TZMABG0700LAE			700	672	5	-
TZMABG0800LAE			800	742	5	-
TZMABG1000LAE			1000	884	5	-



DN

15
18
25



Max temperatura

110 °C



Max pressione

10 bar
10 bar
10 bar



Portata a 3 bar

83 l/min
200 l/min
280 l/min



Raggio min. di curvatura

80 mm
104 mm
132 mm



Tubo interno

EPDM



Treccia

ACCIAIO ZINCATO



Raccordi

ACCIAIO ZINCATO
o
CW617N ZINCATO



Istruzioni

Pag. 438

AC 3201

● G 1" 1/4



Maschio

Femmina

● G 1" 1/4

CODICE	RACCORDI	DN	LUNGHEZZA mm			
VZMAGG0300LAE	Maschio G 1" 1/4 Femmina G 1" 1/4	32	300	681	2	-
VZMAGG0400LAE			400	789	2	-
VZMAGG0500LAE			500	897	2	-
VZMAGG0600LAE			600	1.005	2	-
VZMAGG0700LAE			700	1.113	2	-
VZMAGG0800LAE			800	1.221	2	-
VZMAGG1000LAE			1000	1.437	2	-

AC 4001

● G 1" 1/2



Maschio

Femmina

● G 1" 1/2

CODICE	RACCORDI	DN	LUNGHEZZA mm			
XZMAEB0300LAE	Maschio G 1" 1/2 Femmina G 1" 1/2	40	300	1.097	2	-
XZMAEB0400LAE			400	1.258	2	-
XZMAEB0500LAE			500	1.418	2	-
XZMAEB0600LAE			600	1.579	2	-
XZMAEB0700LAE			700	1.740	2	-
XZMAEB0800LAE			800	1.900	2	-
XZMAEB1000LAE			1000	2.222	2	-

AC 5001

● G 2"



Maschio

Femmina

● G 2"

CODICE	RACCORDI	DN	LUNGHEZZA mm			
ZZMBNB0300LAE	Maschio G 2" Femmina G 2"	50	300	1.553	1	-
ZZMBNB0400LAE			400	1.776	1	-
ZZMBNB0500LAE			500	1.998	1	-
ZZMBNB0600LAE			600	2.221	1	-
ZZMBNB0700LAE			700	2.444	1	-
ZZMBNB0800LAE			800	2.667	1	-
ZZMBNB1000LAE			1000	3.113	1	-



DN
32
40
50



Max temperatura
110 °C



Max pressione
6 bar
6 bar
6 bar



Portata a 3 bar
490 l/min
800 l/min
1300 l/min



Raggio min. di curvatura
168 mm
212 mm
275 mm



Tubo interno
EPDM



Treccia
ACCIAIO ZINCATO



Raccordi
ACCIAIO ZINCATO



Istruzioni
Pag. 438

AC 1502

● G 1/2



● G 1/2

Femmina

Femmina

CODICE	RACCORDI	DN	LUNGHEZZA mm			
QZMFHZ0300LAE	Femmina G 1/2	15	300	183	5	-
QZMFHZ0400LAE			400	218	5	-
QZMFHZ0500LAE			500	253	5	-
QZMFHZ0600LAE			600	287	5	-
QZMFHZ0700LAE			700	322	5	-
QZMFHZ0800LAE			800	356	5	-
QZMFHZ1000LAE			1000	425	5	-

AC 1803

● G 3/4



● G 3/4

Femmina

Femmina

CODICE	RACCORDI	DN	LUNGHEZZA mm			
SZMGCG0300LAE	Femmina G 3/4	18	300	272	5	-
SZMGCG0400LAE			400	323	5	-
SZMGCG0500LAE			500	374	5	-
SZMGCG0600LAE			600	425	5	-
SZMGCG0700LAE			700	476	5	-
SZMGCG0800LAE			800	527	5	-
SZMGCG1000LAE			1000	629	5	-

AC 1804

● G 1"



● G 1"

Femmina

Femmina

CODICE	RACCORDI	DN	LUNGHEZZA mm			
SZMFBG0300LAE	Femmina G 1"	18	300	336	5	-
SZMFBG0400LAE			400	387	5	-
SZMFBG0500LAE			500	438	5	-
SZMFBG0600LAE			600	489	5	-
SZMFBG0700LAE			700	540	5	-
SZMFBG0800LAE			800	590	5	-
SZMFBG1000LAE			1000	693	5	-

AC 2502

● G 1"



● G 1"

Femmina

Femmina

CODICE	RACCORDI	DN	LUNGHEZZA mm			
TZMFBG0300LAE	Femmina G 1"	25	300	388	5	-
TZMFBG0400LAE			400	459	5	-
TZMFBG0500LAE			500	529	5	-
TZMFBG0600LAE			600	600	5	-
TZMFBG0700LAE			700	671	5	-
TZMFBG0800LAE			800	741	5	-
TZMFBG1000LAE			1000	883	5	-



DN

15
18
25



Max temperatura

110 °C



Max pressione

10 bar
10 bar
10 bar



Portata a 3 bar

83 l/min
200 l/min
280 l/min



Raggio min. di curvatura

80 mm
104 mm
132 mm



Tubo interno

EPDM



Treccia

ACCIAIO ZINCATO



Raccordi

ACCIAIO ZINCATO



Istruzioni

Pag. 438

AC 3202

● G 1" 1/4



● G 1" 1/4

Femmina

Femmina

CODICE	RACCORDI	DN	LUNGHEZZA mm			
VZMFFG0300LAE	Femmina G 1" 1/4	32	300	672	2	-
VZMFFG0400LAE			400	780	2	-
VZMFFG0500LAE			500	888	2	-
VZMFFG0600LAE			600	995	2	-
VZMFFG0700LAE			700	1.103	2	-
VZMFFG0800LAE			800	1.211	2	-
VZMFFG1000LAE			1000	1.427	2	-

AC 4002

● G 1" 1/2



● G 1" 1/2

Femmina

Femmina

CODICE	RACCORDI	DN	LUNGHEZZA mm			
XZMFGB0300LAE	Femmina G 1" 1/2	40	300	1.134	2	-
XZMFGB0400LAE			400	1.295	2	-
XZMFGB0500LAE			500	1.456	2	-
XZMFGB0600LAE			600	1.616	2	-
XZMFGB0700LAE			700	1.777	2	-
XZMFGB0800LAE			800	1.937	2	-
XZMFGB1000LAE			1000	2.259	2	-

AC 5002

● G 2"



● G 2"

Femmina

Femmina

CODICE	RACCORDI	DN	LUNGHEZZA mm			
ZZMGAB0300LAE	Femmina G 2"	50	300	1.566	1	-
ZZMGAB0400LAE			400	1.789	1	-
ZZMGAB0500LAE			500	2.012	1	-
ZZMGAB0600LAE			600	2.235	1	-
ZZMGAB0700LAE			700	2.458	1	-
ZZMGAB0800LAE			800	2.681	1	-
ZZMGAB1000LAE			1000	3.127	1	-



DN
32
40
50



Max temperatura
110 °C



Max pressione
6 bar
6 bar
6 bar



Portata a 3 bar
490 l/min
800 l/min
1300 l/min



Raggio min. di curvatura
168 mm
212 mm
275 mm



Tubo interno
EPDM



Treccia
ACCIAIO ZINCATO



Raccordi
ACCIAIO ZINCATO



Istruzioni
Pag. 438

AC 1503

● G 1/2

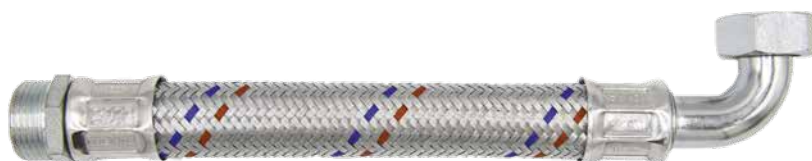

Maschio

Femmina Curva

● G 1/2

CODICE	RACCORDI	DN	LUNGHEZZA mm			
QZMECZ0300LAE	Maschio G 1/2 Femmina Curva G 1/2	15	300	201	5	-
QZMECZ0400LAE			400	236	5	-
QZMECZ0500LAE			500	270	5	-
QZMECZ0600LAE			600	305	5	-
QZMECZ0700LAE			700	340	5	-
QZMECZ0800LAE			800	374	5	-
QZMECZ1000LAE			1000	443	5	-

AC 1805

● G 3/4

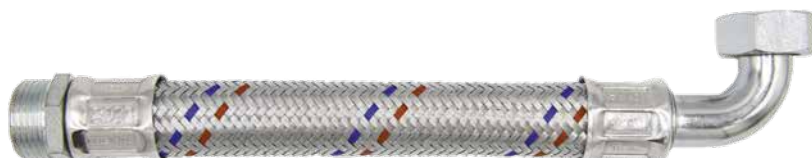

Maschio

Femmina Curva

● G 3/4

CODICE	RACCORDI	DN	LUNGHEZZA mm			
SZMEYG0300LAE	Maschio G 3/4 Femmina Curva G 3/4	18	300	280	5	-
SZMEYG0400LAE			400	330	5	-
SZMEYG0500LAE			500	382	5	-
SZMEYG0600LAE			600	432	5	-
SZMEYG0700LAE			700	483	5	-
SZMEYG0800LAE			800	535	5	-
SZMEYG1000LAE			1000	637	5	-

AC 1806

● G 1"

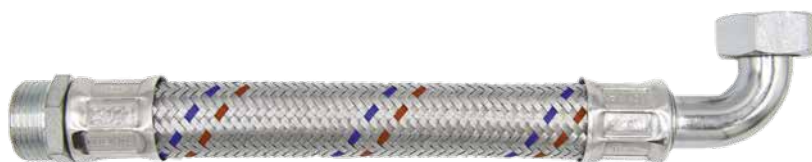

Maschio

Femmina Curva

● G 1"

CODICE	RACCORDI	DN	LUNGHEZZA mm			
SZMDVG0300LAE	Maschio G 1" Femmina Curva G 1"	18	300	317	2	-
SZMDVG0400LAE			400	368	2	-
SZMDVG0500LAE			500	419	2	-
SZMDVG0600LAE			600	470	2	-
SZMDVG0700LAE			700	520	2	-
SZMDVG0800LAE			800	571	2	-
SZMDVG1000LAE			1000	673	2	-



DN
15
18



Max temperatura
110 °C



Max pressione
10 bar
10 bar



Portata a 3 bar
83 l/min
200 l/min



Raggio min. di curvatura
80 mm
104 mm



Tubo interno
EPDM



Treccia
ACCIAIO ZINCATO



Raccordi
ACCIAIO ZINCATO



Istruzioni
Pag. 438

AC 2503

● G 1"

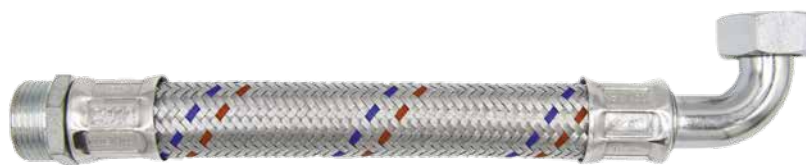

● G 1"

Maschio

Femmina Curva

CODICE	RACCORDI	DN	LUNGHEZZA mm			
TZMDVG0300LAE	Maschio G 1" Femmina Curva G 1"	25	300	394	2	-
TZMDVG0400LAE			400	465	2	-
TZMDVG0500LAE			500	535	2	-
TZMDVG0600LAE			600	606	2	-
TZMDVG0700LAE			700	677	2	-
TZMDVG0800LAE			800	748	2	-
TZMDVG1000LAE			1000	889	2	-

AC 3203

● G 1" 1/4

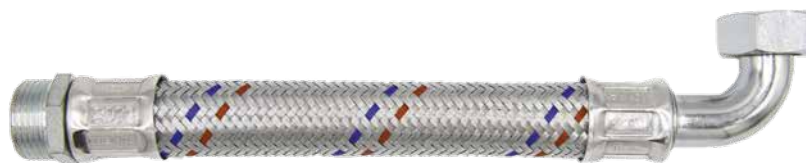

● G 1" 1/4

Maschio

Femmina Curva

CODICE	RACCORDI	DN	LUNGHEZZA mm			
VZMDZG0300LAE	Maschio G 1" 1/4 Femmina Curva in acciaio inox G 1" 1/4	32	300	706	2	-
VZMDZG0400LAE			400	814	2	-
VZMDZG0500LAE			500	922	2	-
VZMDZG0600LAE			600	1.030	2	-
VZMDZG0700LAE			700	1.138	2	-
VZMDZG0800LAE			800	1.246	2	-
VZMDZG1000LAE			1000	1.462	2	-



DN
25
32



Max temperatura
110 °C



Max pressione
10 bar
6 bar



Portata a 3 bar
280 l/min
490 l/min



Raggio min. di curvatura
132 mm
168 mm



Tubo interno
EPDM



Treccia
ACCIAIO ZINCATO



Raccordi
ACCIAIO ZINCATO



Istruzioni
Pag. 438



TUBI FLESSIBILI INDUSTRIALI

4.2 / ACFZ-B

ACFZ-B

RACCORDI IN OTTONE



Per soddisfare le esigenze di più clienti sono nati i tubi ACFZ-B che uniscono l'economicità della treccia in acciaio

zincato alle caratteristiche migliori dei raccordi in ottone. Questi flessibili sono disponibili dal DN15 al DN50.

CARATTERISTICHE TECNICHE



DN

15
18
25
32
40
50



Max temperatura

110 °C



Max pressione

10 bar
10 bar
10 bar
6 bar
6 bar
6 bar



Portata a 3 bar

83 l/min
200 l/min
280 l/min
490 l/min
800 l/min
1300 l/min



Raggio min. di curvatura
80 mm
104 mm
132 mm
168 mm
212 mm
275 mm



Tubo interno

EPDM



Treccia

ACCIAIO
ZINCATO



Raccordi

CW617N

CAMPI DI APPLICAZIONE



pompe



colonne montanti



impianti di riscaldamento



installazioni generiche

TUBO INTERNO



EPDM

La gomma EPDM perossidica è il materiale più utilizzato per la realizzazione del tubo interno.

Con diverse composizioni chimiche, ha proprietà igieniche e meccaniche di alto livello, unitamente ad un'assoluta resistenza all'ossidazione, agli agenti atmosferici ed alle alte temperature.

TIPOLOGIA DI RACCORDI

Maschio (raccordi ottone)

G 1/2
G 3/4
G 1"
G 1" 1/4
G 1" 1/2
G 2"



Femmina (raccordi ottone)

G 1/2
G 3/4
G 1"
G 1" 1/4
G 1" 1/2
G 2"



Femmina Curva (raccordi ottone)

G 1/2
G 3/4
G 1"
G 1" 1/4



Istruzioni
Pag. 438

Per informazioni sulle specifiche tecniche e sui prodotti certificati si prega di rivolgersi ai nostri uffici o visitare il sito web degli enti di certificazione corrispondenti.

AC 1504

● G 1/2



● G 1/2

Maschio (raccordi ottone)

Femmina (raccordi ottone)

CODICE	RACCORDI	DN	LUNGHEZZA mm			
QZMANS0300LAE	Maschio (raccordi ottone) G 1/2	15	300	181	5	-
QZMANS0400LAE			400	216	5	-
QZMANS0500LAE			500	250	5	-
QZMANS0600LAE			600	285	5	-
QZMANS0700LAE	Femmina (raccordi ottone) G 1/2	15	700	320	5	-
QZMANS0800LAE			800	354	5	-
QZMANS1000LAE			1000	423	5	-

AC 1807

● G 3/4



● G 3/4

Maschio (raccordi ottone)

Femmina (raccordi ottone)

CODICE	RACCORDI	DN	LUNGHEZZA mm			
SZMBSS0300LAE	Maschio (raccordi ottone) G 3/4	18	300	265	5	-
SZMBSS0400LAE			400	316	5	-
SZMBSS0500LAE			500	367	5	-
SZMBSS0600LAE			600	418	5	-
SZMBSS0700LAE	Femmina (raccordi ottone) G 3/4	18	700	469	5	-
SZMBSS0800LAE			800	520	5	-
SZMBSS1000LAE			1000	622	5	-

AC 2504

● G 1"



● G 1"

Maschio (raccordi ottone)

Femmina (raccordi ottone)

CODICE	RACCORDI	DN	LUNGHEZZA mm			
TZMAAS0300LAE	Maschio (raccordi ottone) G 1"	25	300	412	5	-
TZMAAS0400LAE			400	483	5	-
TZMAAS0500LAE			500	554	5	-
TZMAAS0600LAE			600	624	5	-
TZMAAS0700LAE	Femmina (raccordi ottone) G 1"	25	700	695	5	-
TZMAAS0800LAE			800	766	5	-
TZMAAS1000LAE			1000	907	5	-



DN
15
18
25



Max temperatura
110 °C



Max pressione
10 bar
10 bar
10 bar



Portata a 3 bar
83 l/min
200 l/min
280 l/min



Raggio min. di curvatura
80 mm
104 mm
132 mm



Tubo interno
EPDM



Treccia
ACCIAIO ZINCATO



Raccordi
CW617N



Istruzioni
Pag. 438

AC 3204

● G 1" 1/4



● G 1" 1/4

Maschio (raccordi ottone)

Femmina (raccordi ottone)

CODICE	RACCORDI	DN	LUNGHEZZA mm			
VZMAFS0300LAE	Maschio (raccordi ottone) G 1" 1/4	32	300	714	2	-
VZMAFS0400LAE			400	822	2	-
VZMAFS0500LAE			500	930	2	-
VZMAFS0600LAE			600	1.038	2	-
VZMAFS0700LAE	Femmina (raccordi ottone) G 1" 1/4	32	700	1.146	2	-
VZMAFS0800LAE			800	1.254	2	-
VZMAFS1000LAE			1000	1.470	2	-

AC 4003

● G 1" 1/2



● G 1" 1/2

Maschio (raccordi ottone)

Femmina (raccordi ottone)

CODICE	RACCORDI	DN	LUNGHEZZA mm			
XZMAES0300LAE	Maschio (raccordi ottone) G 1" 1/2	40	300	1.140	2	-
XZMAES0400LAE			400	1.300	2	-
XZMAES0500LAE			500	1.461	2	-
XZMAES0600LAE			600	1.622	2	-
XZMAES0700LAE	Femmina (raccordi ottone) G 1" 1/2	40	700	1.783	2	-
XZMAES0800LAE			800	1.943	2	-
XZMAES1000LAE			1000	2.264	2	-

AC 5003

● G 2"



● G 2"

Maschio (raccordi ottone)

Femmina (raccordi ottone)

CODICE	RACCORDI	DN	LUNGHEZZA mm			
ZZMBNS0300LAE	Maschio (raccordi ottone) G 2"	50	300	1.641	1	-
ZZMBNS0400LAE			400	1.864	1	-
ZZMBNS0500LAE			500	2.087	1	-
ZZMBNS0600LAE			600	2.310	1	-
ZZMBNS0700LAE	Femmina (raccordi ottone) G 2"	50	700	2.533	1	-
ZZMBNS0800LAE			800	2.756	1	-
ZZMBNS1000LAE			1000	3.202	1	-



DN
32
40
50



Max temperatura
110 °C



Max pressione
6 bar
6 bar
6 bar



Portata a 3 bar
490 l/min
800 l/min
1300 l/min



Raggio min. di curvatura
168 mm
212 mm
275 mm



Tubo interno
EPDM



Treccia
ACCIAIO ZINCATO



Raccordi
CW617N



Istruzioni
Pag. 438

AC 1505



● G 1/2



● G 1/2

Femmina (raccordi ottone)

Femmina (raccordi ottone)

CODICE	RACCORDI	DN	LUNGHEZZA mm			
QZMFHS0300LAE	Femmina (raccordi ottone) G 1/2	15	300	185	5	-
QZMFHS0400LAE			400	220	5	-
QZMFHS0500LAE			500	255	5	-
QZMFHS0600LAE			600	289	5	-
QZMFHS0700LAE	Femmina (raccordi ottone) G 1/2	15	700	323	5	-
QZMFHS0800LAE			800	358	5	-
QZMFHS1000LAE			1000	427	5	-

AC 1808



● G 3/4



● G 3/4

Femmina (raccordi ottone)

Femmina (raccordi ottone)

CODICE	RACCORDI	DN	LUNGHEZZA mm			
SZMGBS0300LAE	Femmina (raccordi ottone) G 3/4	18	300	270	5	-
SZMGBS0400LAE			400	321	5	-
SZMGBS0500LAE			500	372	5	-
SZMGBS0600LAE			600	423	5	-
SZMGBS0700LAE	Femmina (raccordi ottone) G 3/4	18	700	474	5	-
SZMGBS0800LAE			800	525	5	-
SZMGBS1000LAE			1000	627	5	-

AC 2505



● G 1"



● G 1"

Femmina (raccordi ottone)

Femmina (raccordi ottone)

CODICE	RACCORDI	DN	LUNGHEZZA mm			
TZMFAS0300LAE	Femmina (raccordi ottone) G 1"	25	300	508	5	-
TZMFAS0400LAE			400	578	5	-
TZMFAS0500LAE			500	649	5	-
TZMFAS0600LAE			600	720	5	-
TZMFAS0700LAE	Femmina (raccordi ottone) G 1"	25	700	790	5	-
TZMFAS0800LAE			800	861	5	-
TZMFAS1000LAE			1000	1.002	5	-



DN

15
18
25

Max temperatura

110 °C



Max pressione

10 bar
10 bar
10 bar

Portata a 3 bar

83 l/min
200 l/min
280 l/min

Raggio min. di curvatura

80 mm
104 mm
132 mm

Tubo interno

EPDM



Treccia

ACCIAIO ZINCATO



Raccordi

CW617N



Istruzioni

Pag. 438

AC 3205

● G 1" 1/4



● G 1" 1/4

Femmina (raccordi ottone)

Femmina (raccordi ottone)

CODICE	RACCORDI	DN	LUNGHEZZA mm			
VZMFES0300LAE	Femmina (raccordi ottone) G 1" 1/4	32	300	704	2	-
VZMFES0400LAE			400	812	2	-
VZMFES0500LAE			500	920	2	-
VZMFES0600LAE			600	1.028	2	-
VZMFES0700LAE	Femmina (raccordi ottone) G 1" 1/4	32	700	1.136	2	-
VZMFES0800LAE			800	1.244	2	-
VZMFES1000LAE			1000	1.460	2	-

AC 4004

● G 1" 1/2



● G 1" 1/2

Femmina (raccordi ottone)

Femmina (raccordi ottone)

CODICE	RACCORDI	DN	LUNGHEZZA mm			
XZMFGS0300LAE	Femmina (raccordi ottone) G 1" 1/2	40	300	1.180	2	-
XZMFGS0400LAE			400	1.341	2	-
XZMFGS0500LAE			500	1.501	2	-
XZMFGS0600LAE			600	1.662	2	-
XZMFGS0700LAE	Femmina (raccordi ottone) G 1" 1/2	40	700	1.823	2	-
XZMFGS0800LAE			800	1.983	2	-
XZMFGS1000LAE			1000	2.305	2	-

AC 5004

● G 2"



● G 2"

Femmina (raccordi ottone)

Femmina (raccordi ottone)

CODICE	RACCORDI	DN	LUNGHEZZA mm			
ZZMGAS0300LAE	Femmina (raccordi ottone) G 2"	50	300	1.672	1	-
ZZMGAS0400LAE			400	1.895	1	-
ZZMGAS0500LAE			500	2.118	1	-
ZZMGAS0600LAE			600	2.341	1	-
ZZMGAS0700LAE	Femmina (raccordi ottone) G 2"	50	700	2.564	1	-
ZZMGAS0800LAE			800	2.787	1	-
ZZMGAS1000LAE			1000	3.233	1	-



DN
32
40
50



Max temperatura
110 °C



Max pressione
6 bar
6 bar
6 bar



Portata a 3 bar
490 l/min
800 l/min
1300 l/min



Raggio min. di curvatura
168 mm
212 mm
275 mm



Tubo interno
EPDM



Treccia
ACCIAIO ZINCATO



Raccordi
CW617N



Istruzioni
Pag. 438

AC 1506

● G 1/2

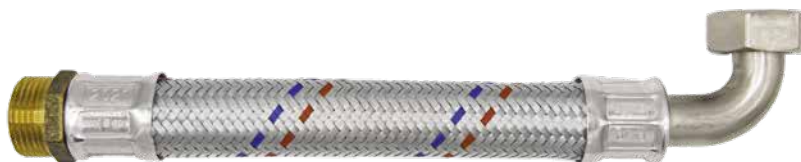

● G 1/2

Maschio (raccordi ottone)

Femmina Curva (raccordi ottone)

CODICE	RACCORDI	DN	LUNGHEZZA mm			
QZMECS0300LAE	Maschio (raccordi ottone) G 1/2	15	300	195	5	-
QZMECS0400LAE			400	230	5	-
QZMECS0500LAE			500	265	5	-
QZMECS0600LAE			600	299	5	-
QZMECS0700LAE	Femmina Curva (raccordi ottone) G 1/2	15	700	333	5	-
QZMECS0800LAE			800	368	5	-
QZMECS1000LAE			1000	437	5	-

AC 1809

● G 3/4

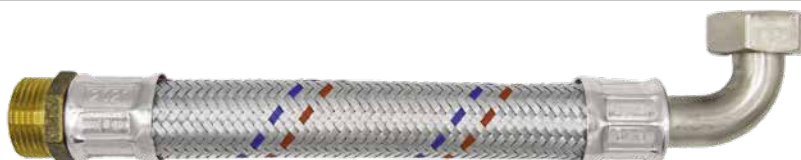

● G 3/4

Maschio (raccordi ottone)

Femmina Curva (raccordi ottone)

CODICE	RACCORDI	DN	LUNGHEZZA mm			
SZMENS0300LAE	Maschio (raccordi ottone) G 3/4	18	300	272	5	-
SZMENS0400LAE			400	323	5	-
SZMENS0500LAE			500	374	5	-
SZMENS0600LAE			600	425	5	-
SZMENS0700LAE	Femmina Curva (raccordi ottone) G 3/4	18	700	476	5	-
SZMENS0800LAE			800	527	5	-
SZMENS1000LAE			1000	627	5	-

AC 2506

● G 1"

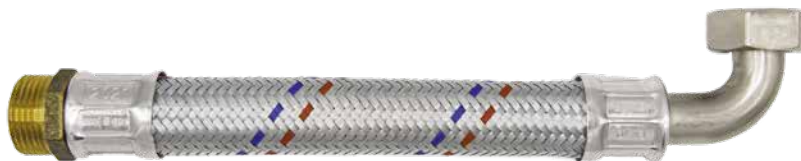

● G 1"

Maschio (raccordi ottone)

Femmina Curva (raccordi ottone)

CODICE	RACCORDI	DN	LUNGHEZZA mm			
TZMDUS0300LAE	Maschio (raccordi ottone) G 1"	25	300	413	2	-
TZMDUS0400LAE			400	483	2	-
TZMDUS0500LAE			500	554	2	-
TZMDUS0600LAE			600	625	2	-
TZMDUS0700LAE	Femmina Curva (raccordi ottone) G 1"	25	700	695	2	-
TZMDUS0800LAE			800	766	2	-
TZMDUS1000LAE			1000	906	2	-

AC 3206

● G 1" 1/4

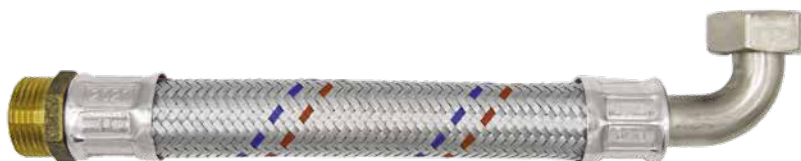

● G 1" 1/4

Maschio (raccordi ottone)

Femmina Curva

CODICE	RACCORDI	DN	LUNGHEZZA mm			
VZMDYS0300LAE	Maschio (raccordi ottone) G 1" 1/4	32	300	715	2	-
VZMDYS0400LAE			400	823	2	-
VZMDYS0500LAE			500	931	2	-
VZMDYS0600LAE			600	1.039	2	-
VZMDYS0700LAE	Femmina Curva in acciaio inox G 1" 1/4	32	700	1.147	2	-
VZMDYS0800LAE			800	1.255	2	-
VZMDYS1000LAE			1000	1.470	2	-



DN

15
18
25
32



Max temperatura

110 °C



Max pressione

10 bar
10 bar
10 bar
6 bar



Portata a 3 bar

83 l/min
200 l/min
280 l/min
490 l/min



Raggio min. di curvatura

80 mm
104 mm
132 mm
168 mm



Tubo interno

EPDM



Treccia

ACCIAIO ZINCATO



Raccordi

CW617N



Istruzioni

Pag. 438



TUBI FLESSIBILI INDUSTRIALI

4.3 / ACFX

ACFX

FLESSIBILI IN ACCIAIO INOX



Rivestiti di treccia metallica INOX con raccordi in OTTONE, sono adatti al collegamento di pompe, caldaie, autoclavi

e colonne montanti, l'ideale per le applicazioni industriali. Sono disponibili dal diametro DN15 al DN50.

CARATTERISTICHE TECNICHE



DN

15
18
25
32
40
50



Max temperatura

110 °C



Max pressione

10 bar
10 bar
10 bar
6 bar
6 bar
6 bar



Portata a 3 bar

83 l/min
200 l/min
280 l/min
490 l/min
800 l/min
1300 l/min



Raggio min. di curvatura
80 mm
104 mm
132 mm
168 mm
212 mm
275 mm



Tubo interno

EPDM



Treccia

INOX AISI 304



Raccordi

CW617N

CAMPI DI APPLICAZIONE



pompe



colonne montanti



impianti di riscaldamento



impianti condizionamento



installazioni generiche

TUBO INTERNO



EPDM

La gomma EPDM perossidica è il materiale più utilizzato per la realizzazione del tubo interno.

Con diverse composizioni chimiche, ha proprietà igieniche e meccaniche di alto livello, unitamente ad un'assoluta resistenza all'ossidazione, agli agenti atmosferici ed alle alte temperature.

TIPOLOGIA DI RACCORDI

Maschio

G 1/2
G 3/4
G 1"
G 1" 1/4
G 1" 1/2
G 2"



Femmina

G 1/2
G 3/4
G 1"
G 1" 1/4
G 1" 1/2
G 2"



Femmina Curva

G 1/2
G 3/4
G 1"
G 1" 1/4



CERTIFICAZIONI

EN 13618

UE



DN 15-18-25



TÜV

Germania



Istruzioni
Pag. 438

Per informazioni sulle specifiche tecniche e sui prodotti certificati si prega di rivolgersi ai nostri uffici o visitare il sito web degli enti di certificazione corrispondenti.

AC 1507

● G 1/2



● G 1/2

Maschio (raccordi ottone)

Femmina (raccordi ottone)

CODICE	RACCORDI	DN	LUNGHEZZA mm			
QCMANS0300TAE	Maschio (raccordi ottone) G 1/2	15	300	167	5	-
QCMANS0400TAE			400	196	5	-
QCMANS0500TAE			500	225	5	-
QCMANS0600TAE			600	254	5	-
QCMANS0700TAE	Femmina (raccordi ottone) G 1/2	15	700	283	5	-
QCMANS0800TAE			800	612	5	-
QCMANS1000TAE			1000	871	5	-

AC 1810

● G 3/4



● G 3/4

Maschio (raccordi ottone)

Femmina (raccordi ottone)

CODICE	RACCORDI	DN	LUNGHEZZA mm			
SCMBSS0300TAE	Maschio (raccordi ottone) G 3/4	18	300	247	5	-
SCMBSS0400TAE			400	291	5	-
SCMBSS0500TAE			500	335	5	-
SCMBSS0600TAE			600	379	5	-
SCMBSS0700TAE	Femmina (raccordi ottone) G 3/4	18	700	423	5	-
SCMBSS0800TAE			800	467	5	-
SCMBSS1000TAE			1000	555	5	-

AC 2507

● G 1"



● G 1"

Maschio (raccordi ottone)

Femmina (raccordi ottone)

CODICE	RACCORDI	DN	LUNGHEZZA mm			
TCMAAS0300TAE	Maschio (raccordi ottone) G 1"	25	300	398	5	-
TCMAAS0400TAE			400	464	5	-
TCMAAS0500TAE			500	529	5	-
TCMAAS0600TAE			600	594	5	-
TCMAAS0700TAE	Femmina (raccordi ottone) G 1"	25	700	660	5	-
TCMAAS0800TAE			800	725	5	-
TCMAAS1000TAE			1000	856	5	-



DN
15
18
25



Max temperatura
110 °C



Max pressione
10 bar
10 bar
10 bar



Portata a 3 bar
83 l/min
200 l/min
280 l/min



Raggio min. di curvatura
80 mm
104 mm
132 mm



Tubo interno
EPDM



Treccia
INOX AISI 304



Raccordi
CW617N



Istruzioni
Pag. 438

AC 3207

● G 1" 1/4



● G 1" 1/4

Maschio (raccordi ottone)

Femmina (raccordi ottone)

CODICE	RACCORDI	DN	LUNGHEZZA mm			
VCMAFS0300TAE	Maschio (raccordi ottone) G 1" 1/4	32	300	684	2	-
VCMAFS0400TAE			400	780	2	-
VCMAFS0500TAE			500	876	2	-
VCMAFS0600TAE			600	972	2	-
VCMAFS0700TAE	Femmina (raccordi ottone) G 1" 1/4	32	700	1.068	2	-
VCMAFS0800TAE			800	1.164	2	-
VCMAFS1000TAE			1000	1.356	2	-

AC 4005

● G 1" 1/2



● G 1" 1/2

Maschio (raccordi ottone)

Femmina (raccordi ottone)

CODICE	RACCORDI	DN	LUNGHEZZA mm			
XCMAES0300TAE	Maschio (raccordi ottone) G 1" 1/2	40	300	1.136	2	-
XCMAES0400TAE			400	1.296	2	-
XCMAES0500TAE			500	1.456	2	-
XCMAES0600TAE			600	1.616	2	-
XCMAES0700TAE	Femmina (raccordi ottone) G 1" 1/2	40	700	1.776	2	-
XCMAES0800TAE			800	1.936	2	-
XCMAES1000TAE			1000	2.256	2	-

AC 5005

● G 2"



● G 2"

Maschio (raccordi ottone)

Femmina (raccordi ottone)

CODICE	RACCORDI	DN	LUNGHEZZA mm			
ZCMBNS0300TAE	Maschio (raccordi ottone) G 2"	50	300	1.618	1	-
ZCMBNS0400TAE			400	1.840	1	-
ZCMBNS0500TAE			500	2.063	1	-
ZCMBNS0600TAE			600	2.285	1	-
ZCMBNS0700TAE	Femmina (raccordi ottone) G 2"	50	700	2.507	1	-
ZCMBNS0800TAE			800	2.729	1	-
ZCMBNS1000TAE			1000	3.174	1	-



DN
32
40
50



Max temperatura
110 °C



Max pressione
6 bar
6 bar
6 bar



Portata a 3 bar
490 l/min
800 l/min
1300 l/min



Raggio min. di curvatura
168 mm
212 mm
275 mm



Tubo interno
EPDM



Treccia
INOX AISI 304



Raccordi
CW617N



Istruzioni
Pag. 438

AC 1508

● G 1/2



● G 1/2

Femmina (raccordi ottone)

Femmina (raccordi ottone)

CODICE	RACCORDI	DN	LUNGHEZZA mm			
QCMFHS0300TAE	Femmina (raccordi ottone) G 1/2	15	300	171	5	-
QCMFHS0400TAE			400	200	5	-
QCMFHS0500TAE			500	229	5	-
QCMFHS0600TAE			600	258	5	-
QCMFHS0700TAE	Femmina (raccordi ottone) G 1/2	15	700	287	5	-
QCMFHS0800TAE			800	316	5	-
QCMFHS1000TAE			1000	374	5	-

AC 1811

● G 3/4



● G 3/4

Femmina (raccordi ottone)

Femmina (raccordi ottone)

CODICE	RACCORDI	DN	LUNGHEZZA mm			
SCMGBS0300TAE	Femmina (raccordi ottone) G 3/4	18	300	251	5	-
SCMGBS0400TAE			400	295	5	-
SCMGBS0500TAE			500	339	5	-
SCMGBS0600TAE			600	383	5	-
SCMGBS0700TAE	Femmina (raccordi ottone) G 3/4	18	700	427	5	-
SCMGBS0800TAE			800	471	5	-
SCMGBS1000TAE			1000	559	5	-

AC 2508

● G 1"



● G 1"

Femmina (raccordi ottone)

Femmina (raccordi ottone)

CODICE	RACCORDI	DN	LUNGHEZZA mm			
TCMFAS0300TAE	Femmina (raccordi ottone) G 1"	25	300	403	5	-
TCMFAS0400TAE			400	469	5	-
TCMFAS0500TAE			500	534	5	-
TCMFAS0600TAE			600	599	5	-
TCMFAS0700TAE	Femmina (raccordi ottone) G 1"	25	700	665	5	-
TCMFAS0800TAE			800	730	5	-
TCMFAS1000TAE			1000	861	5	-



DN
15
18
25



Max temperatura
110 °C



Max pressione
10 bar
10 bar
10 bar



Portata a 3 bar
83 l/min
200 l/min
280 l/min



Raggio min. di curvatura
80 mm
104 mm
132 mm



Tubo interno
EPDM



Treccia
INOX AISI 304



Raccordi
CW617N



Istruzioni
Pag. 438

AC 3208

● G 1" 1/4



● G 1" 1/4

Femmina (raccordi ottone)

Femmina (raccordi ottone)

CODICE	RACCORDI	DN	LUNGHEZZA mm			
VCMFES0300TAE	Femmina (raccordi ottone) G 1" 1/4	32	300	673	2	-
VCMFES0400TAE			400	769	2	-
VCMFES0500TAE			500	865	2	-
VCMFES0600TAE			600	961	2	-
VCMFES0700TAE	Femmina (raccordi ottone) G 1" 1/4	32	700	1.057	2	-
VCMFES0800TAE			800	1.154	2	-
VCMFES1000TAE			1000	1.346	2	-

AC 4006

● G 1" 1/2



● G 1" 1/2

Femmina (raccordi ottone)

Femmina (raccordi ottone)

CODICE	RACCORDI	DN	LUNGHEZZA mm			
XCMFGS0300TAE	Femmina (raccordi ottone) G 1" 1/2	40	300	1.176	2	-
XCMFGS0400TAE			400	1.336	2	-
XCMFGS0500TAE			500	1.496	2	-
XCMFGS0600TAE			600	1.656	2	-
XCMFGS0700TAE	Femmina (raccordi ottone) G 1" 1/2	40	700	1.816	2	-
XCMFGS0800TAE			800	1.976	2	-
XCMFGS1000TAE			1000	2.296	2	-

AC 5006

● G 2"



● G 2"

Femmina (raccordi ottone)

Femmina (raccordi ottone)

CODICE	RACCORDI	DN	LUNGHEZZA mm			
ZCMGAS0300TAE	Femmina (raccordi ottone) G 2"	50	300	1.628	1	-
ZCMGAS0400TAE			400	1.850	1	-
ZCMGAS0500TAE			500	2.073	1	-
ZCMGAS0600TAE			600	2.295	1	-
ZCMGAS0700TAE	Femmina (raccordi ottone) G 2"	50	700	2.517	1	-
ZCMGAS0800TAE			800	2.739	1	-
ZCMGAS1000TAE			1000	3.184	1	-



DN
32
40
50



Max temperatura
110 °C



Max pressione
6 bar
6 bar
6 bar



Portata a 3 bar
490 l/min
800 l/min
1300 l/min



Raggio min. di curvatura
168 mm
212 mm
275 mm



Tubo interno
EPDM



Treccia
INOX AISI 304



Raccordi
CW617N



Istruzioni
Pag. 438

AC 1509

● G 1/2



● G 1/2

Maschio (raccordi ottone)

Femmina Curva (raccordi ottone)

CODICE	RACCORDI	DN	LUNGHEZZA mm				
QCMECS0300TAE	Maschio (raccordi ottone) G 1/2	15	300	183	5	-	
QCMECS0400TAE			400	212	5	-	
QCMECS0500TAE			500	241	5	-	
QCMECS0600TAE			600	270	5	-	
QCMECS0700TAE			Femmina Curva (raccordi ottone) G 1/2	700	299	5	-
QCMECS0800TAE			800	328	5	-	
QCMECS1000TAE			1000	386	5	-	

AC 1812

● G 3/4



● G 3/4

Maschio (raccordi ottone)

Femmina Curva (raccordi ottone)

CODICE	RACCORDI	DN	LUNGHEZZA mm				
SCMENS0300TAE	Maschio (raccordi ottone) G 3/4	18	300	256	5	-	
SCMENS0400TAE			400	300	5	-	
SCMENS0500TAE			500	344	5	-	
SCMENS0600TAE			600	388	5	-	
SCMENS0700TAE			Femmina Curva (raccordi ottone) G 3/4	700	432	5	-
SCMENS0800TAE			800	476	5	-	
SCMENS1000TAE			1000	564	5	-	

AC 2509

● G 1"



● G 1"

Maschio (raccordi ottone)

Femmina Curva (raccordi ottone)

CODICE	RACCORDI	DN	LUNGHEZZA mm				
TCMDUS0300TAE	Maschio (raccordi ottone) G 1"	25	300	400	2	-	
TCMDUS0400TAE			400	466	2	-	
TCMDUS0500TAE			500	531	2	-	
TCMDUS0600TAE			600	596	2	-	
TCMDUS0700TAE			Femmina Curva (raccordi ottone) G 1"	700	662	2	-
TCMDUS0800TAE			800	727	2	-	
TCMDUS1000TAE			1000	858	2	-	

AC 3209

● G 1" 1/4



● G 1" 1/4

Maschio (raccordi ottone)

Femmina Curva

CODICE	RACCORDI	DN	LUNGHEZZA mm				
VCMDYS0300TAE	Maschio (raccordi ottone) G 1" 1/4	32	300	689	2	-	
VCMDYS0400TAE			400	785	2	-	
VCMDYS0500TAE			500	881	2	-	
VCMDYS0600TAE			600	977	2	-	
VCMDYS0700TAE			Femmina Curva in acciaio inox G 1" 1/4	700	1.073	2	-
VCMDYS0800TAE			800	1.169	2	-	
VCMDYS1000TAE			1000	1.361	2	-	



DN

15
18
25
32



Max temperatura

110 °C



Max pressione

10 bar
10 bar
10 bar
6 bar



Portata a 3 bar

83 l/min
200 l/min
280 l/min
490 l/min



Raggio min. di curvatura

80 mm
104 mm
132 mm
168 mm



Tubo interno

EPDM



Treccia

INOX AISI 304



Raccordi

CW617N



Istruzioni

Pag. 438



TUBI FLESSIBILI INDUSTRIALI

4.4 / ACEX

ACEX

FLESSIBILI ESTENSIBILI



Per il collegamento tra la rete idrica e le caldaie murali. Flessibile metallico estensibile con soffiutto in acciaio inox di-

ponibile in diverse misure per soddisfare le esigenze dell'installatore e dei produttori di caldaie murali.

CARATTERISTICHE TECNICHE



DN

15
20
25



Max temperatura

90 °C



Max pressione

6
4
4



Portata a 3 bar

-



Raggio min. di curvatura

-



Tubo interno

AISI 316



Treccia

-



Raccordi

AISI 303
CW614N

CAMPI DI APPLICAZIONE



pompe



colonne montanti



impianti di riscaldamento



impianti condizionamento



installazioni generiche

TIPOLOGIA DI RACCORDI

Maschio

R 1/2
R 3/4
R 1"



Femmina

G 1/2
G 3/4
G 1"



Istruzioni
Pag. 438

Per informazioni sulle specifiche tecniche e sui prodotti certificati si prega di rivolgersi ai nostri uffici o visitare il sito web degli enti di certificazione corrispondenti.

AC 1510

● G 1/2



Maschio

Femmina

● G 1/2

CODICE	RACCORDI	DN	LUNGHEZZA mm			
81200100	Maschio R 1/2	15	90 x 140	78	-	10
81200200			130 x 220	86	-	10
81200300	Femmina G 1/2		220 x 420	112	-	10

AC 1511

● G 1/2



Maschio

Femmina

● G 3/4

CODICE	RACCORDI	DN	LUNGHEZZA mm			
81210100	Maschio R 1/2	15	90 x 140	100	-	10
81210200			130 x 220	112	-	10
81210300	Femmina G 3/4		220 x 420	152	-	10

AC 2001

● G 3/4



Maschio

Femmina

● G 3/4

CODICE	RACCORDI	DN	LUNGHEZZA mm			
81220100	Maschio R 3/4	20	90 x 140	102	-	10
81220200			130 x 220	118	-	10
81220300	Femmina G 3/4		220 x 420	164	-	10

AC 2510

● G 1"



Maschio

Femmina

● G 1"

CODICE	RACCORDI	DN	LUNGHEZZA mm			
81230100	Maschio R 1"	25	90 x 140	196	-	10
81230200			130 x 220	222	-	10
81230300	Femmina G 1"		220 x 420	296	-	10



DN
15
20
25



Max temperatura
90 °C



Max pressione
6
4
4



Portata a 3 bar
-



Raggio min. di curvatura
-



Tubo interno
AISI 316



Treccia
-



Raccordi
AISI 303
CW614N



Istruzioni
Pag. 438

ISTRUZIONI DI INSTALLAZIONE

I tubi flessibili Luxor Spa sono progettati per l'adduzione e la distribuzione di acqua. Il trasporto di altri liquidi o soluzioni non viene garantito se non espressamente concordato con l'Ufficio Tecnico.

Eseguire sempre il collaudo dell'impianto dopo l'installazione dei tubi flessibili per verificare perdite o difettosità funzionali del prodotto.

Verificare la corretta messa a terra delle apparecchiature elettriche (impianti di condizionamento, vasche idromassaggio, ecc.) a cui vengono collegati i tubi flessibili.

Eventuali correnti disperse potrebbero favorire il fenomeno della corrosione. Per impianti situati in condizioni di umidità molto elevata e in cui si genera condensa è necessario utilizzare tubi flessibili con treccia e bussole inox.

Progettare l'impianto utilizzando flessibili di lunghezza adeguata e raccordi atti a ridurre al minimo torsioni e tensioni del tubo (verificare sempre le schede del prodotto).

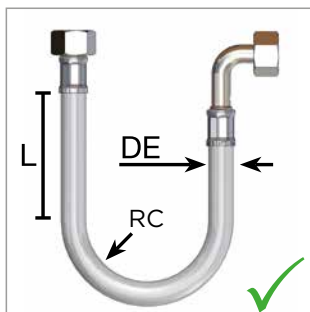

$RC \geq 4 DE$ $L \geq 4 DE$



Verificare sempre che le bussole di serraggio siano pressate e che non fuoriescano fili di treciatura. In caso di dubbio non installare il tubo flessibile.



I flessibili devono mantenere un tratto rettilineo in corrispondenza dei raccordi pari a 4 volte il diametro esterno del tubo (DN6 = Ø 10mm → tratto rettilineo 40 mm), il raggio di curvatura non deve essere inferiore a 4 volte il diametro esterno del tubo (DN6 = Ø 10mm → raggio di curvatura 40 mm).

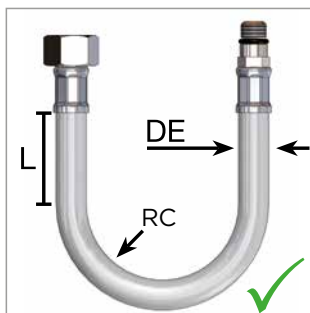

$RC \geq 4 DE$ $L \geq 4 DE$



Non installare il tubo flessibile in condizioni di torsione o tensione.

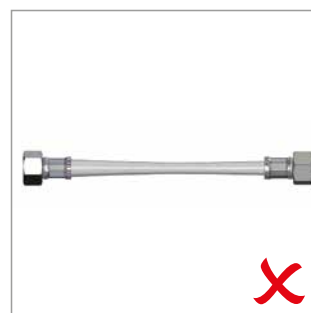

I flessibili devono poter essere ispezionati. Non installare all'interno di muri o in cunicoli non ispezionabili. Non rivestire con materiale isolante (tranne in caso di flessibili con treccia inox e bussole inox).

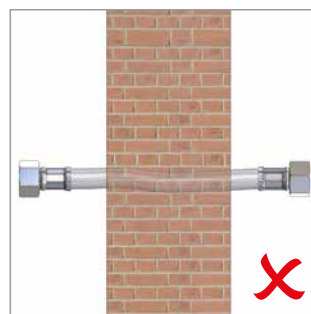
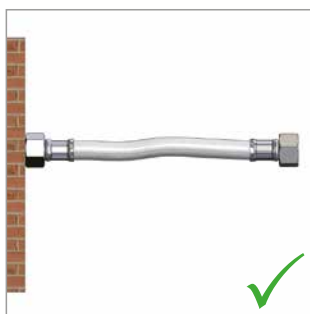

Utilizzare solo attrezzi adeguati alla tipologia di prodotto. Gli attrezzi vanno utilizzati solo in presenza di dado esagonale, ogni altra configurazione (raccordo cilindrico, ghiera zigrinata, ...) deve esser chiusa a mano (forza di chiusura non superiore a 3 Nm).



Non utilizzare alcun attrezzo sulla bussola di serraggio. Una forza applicata a questa bussola ne determina spesso il danneggiamento e la conseguente rottura del tubo flessibile.

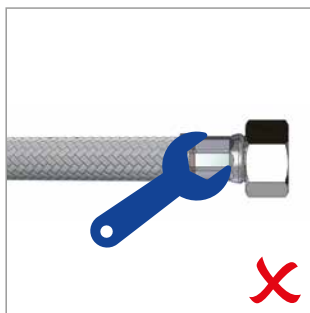

Non assemblare mai due o più flessibili in serie, in caso scegliere una lunghezza maggiore.



Evitare di colpire il tubo con oggetti taglienti o appuntiti per non danneggiare la treccia esterna.

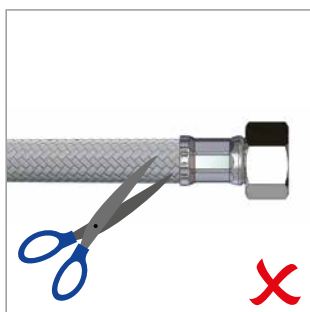

ISTRUZIONI DI MANUTENZIONE

- Monitorare periodicamente lo stato dei tubi flessibili, in caso di ossidazione o evidente stato di usura provvedere alla sostituzione.
- Evitare l'esposizione diretta o indiretta a sostanze corrosive, comprese sostanze utilizzate per le pulizie (candeggina e similari).
- Per la pulizia utilizzare solo panni umidi (non bagnati) senza l'ausilio di sostanze per la pulizia.
- Evitare di colpire il tubo con oggetti taglienti o appuntiti per evitare la rottura della treccia esterna (comprese cassette e contenitori metallici, in legno o altri materiali).
- In caso di impianti in luoghi periodicamente disabitati (per esempio case vacanze oppure in luoghi con condizioni climatiche particolarmente rigide) verificare sempre la chiusura dell'impianto e, in ogni caso, evitare di lasciare l'impianto in pressione.



5 / COLLEGAMENTI RIGIDI SOTTOLAVABO

COLLEGAMENTI RIGIDI SOTTOLAVABO



CARATTERISTICHE TECNICHE



Max temperatura

90 °C



Max pressione

10 bar

CARATTERISTICHE COSTRUTTIVE

I collegamenti rigidi sottolavabo offrono tutta la qualità e la garanzia del prodotto Made in Italy. La gamma dei prodotti include svariati tubetti in rame cromato, curvette direzionabili attraverso raccordi snodabili e squadrette sfilabili a lunghezza variabile, tutte soluzioni tecniche che fanno dei collegamenti rigidi sottolavabo Luxor la soluzione ideale per ogni tipo di installazione.

GAMMA

Tutta la gamma viene prodotta con finitura cromata a telaio che garantisce maggiori spessori di ricopertura e di conseguenza una maggiore resistenza all'invecchiamento e alla corrosione, nonché una finitura estetica di livello superiore. Tale cromatura viene realizzata utilizzando sostanze e processi galvanici conformi alle più rigide normative internazionali in

materia di sanità e di sicurezza ambientale.

TUBETTI

I tubetti di collegamento vengono realizzati utilizzando rame disossidato al fosforo qualità Cu-DHP con composizione chimica Cu 99,9% min, le cui caratteristiche meccaniche, le dimensioni e le tolleranze sono rispondenti alla norma EN1057 e norme ad essa collegate. Per offrire una migliore qualità di prodotto i tubetti vengono lucidati al momento del taglio e viene eseguita una "doppia cartellatura" che garantisce una maggiore resistenza in fase di assemblaggio e assicura l'eliminazione di bave e spigoli vivi causa di possibili perdite. Tutti i particolari realizzati vengono rigorosamente lavati in vasche ad ultrasuoni con agenti neutri che permettono di eliminare sostanze di lavorazione residue.

SQUADRETTE E RACCORDI

Le squadrette e i raccordi in ottone CW617N e CW614N sono a basso contenuto di piombo in conformità alle più recenti normative UNI EN12165 e UNI EN12164.

ROSETTE

Le rosette sono realizzate in acciaio inox AISI 430 resistente all'azione degli agenti atmosferici, alle soluzioni alcaline degli acidi organici e all'ossidazione fino ad alte temperature.

Le tenute sono garantite dall'utilizzo di guarnizioni piane in EPDM perossidico e da cartucce di serraggio idonee per l'aduzione di acqua potabile.



CARTUCCIA RCC



La cartuccia RCC è la soluzione più sicura e funzionale per la connessione dei collegamenti rigidi sottolavabo alle utenze finali. Essendo i tre componenti raccolti in un corpo unico, la cartuccia RCC è la soluzione definitiva ai problemi di installazione dei raccordi a compressione.

Non più componenti persi o montati in modo erraneo, ma un solo pezzo che garantisce un'ottima tenuta meccanica e idraulica allo stesso tempo.

1. Rondella a stringere in ottone CW614N

La rondella in ottone possiede ottime caratteristiche meccaniche grazie al processo di ricottura che migliora la malleabilità del materiale garantendo il corretto accoppiamento tra raccordo e tubo senza esercitare un'eccessiva forza di serraggio.

2. Guarnizione interna in NBR

Campo di utilizzo per temperature fino a 90°C: le guarnizioni in NBR possiedono buone proprietà meccaniche, bassa deformazione permanente e bassa permeabilità al gas.

3. Cartuccia esterna in Nylon (Poliammide 6.6)

Campo di utilizzo per temperature fino a 90°C: la cartuccia in Nylon possiede ottime caratteristiche di resistenza meccanica accoppiate a grande tenacità ed elevata resistenza all'urto.

ISTRUZIONI DI INSTALLAZIONE



Attenzione

- Verificare il corretto verso della cartuccia.
- Coppia di serraggio consigliata da 25 a 30 Nm max.

Per il corretto montaggio dei collegamenti rigidi sottolavabo è necessario attenersi alla sequenza sopra indicata, verificando

scrupolosamente il verso di assemblaggio di cartuccia e guarnizioni. È quindi importante collegare per prima cosa il nipplo con rosetta alla rete idrica, inserire correttamente le eventuali guarnizioni tra la curvetta e il nipplo, inserire la cartuccia RCC all'interno del dado di serraggio facendo attenzione al verso di inserimento e in fine serrare il raccordo al tubetto.

TUBETTI RAME CROMATO

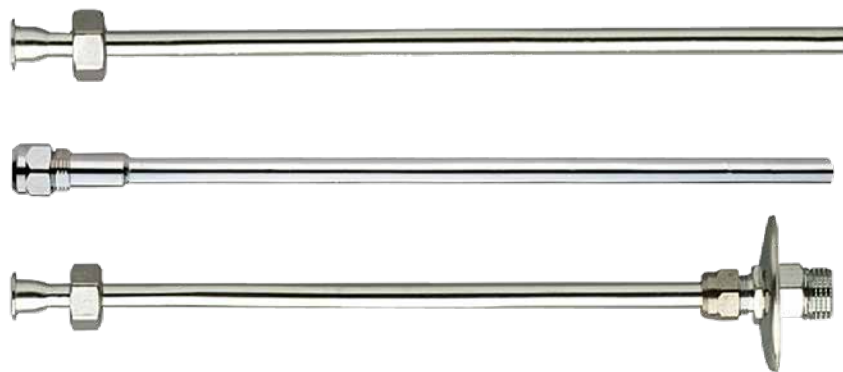

I tubetti in rame cromato Luxor Spa vengono utilizzati per collegare i rubinetti o i miscelatori alla rete idrica. In particolare si utilizzano dove i collegamenti sottolavabo restano scoperti ed è di conseguenza necessario un grado estetico elevato.

Si utilizzano inoltre dove non ci sono lunghezze di collegamento predefinite, lasciando quindi la possibilità all'installatore di rendere la lunghezza dei tubetti rame idonea ad ogni situazione.

Applicazioni:

- Lavabi aperti, con collegamenti a vista, senza coperture
- Bidet aperti, con collegamenti a vista, senza coperture
- Applicazioni personalizzate con ingombri specifici

- Lavabi con comandi a pedale
- Casette di scarico WC esterne

I tubetti cromati Luxor Spa sono realizzati in rame disossidato al 99,9%. La cartellatura delle estremità è doppia per garantire una maggiore resistenza in fase di collegamento.

Tutte le cannette vengono sbavate, lucidate e cromate al fine di distribuire un prodotto di immediato utilizzo e con un'ottima finitura estetica. La serie di tubetti in rame cromati Luxor Spa è corredata da accessori come raccordi a compressione, riduzioni e rosette copri foro.



TUBETTO IN RAME CROMATO

Tubetto con flangia ricavata, raccordo a compressione e cartuccia a 3 pezzi.

CODICE	RACCORDI	A	B	C	D	E	F	G	H	L			
05060125CC	M 3/8 - F 3/8	14	10	17	19	19	G 3/8	G 3/8	-	250	107	-	20
05060130CC		14	10	17	19	19	G 3/8	G 3/8	-	300	116	-	20
05060135CC		14	10	17	19	19	G 3/8	G 3/8	-	350	125	-	20
05060140CC		14	10	17	19	19	G 3/8	G 3/8	-	400	134	10	-
05060150CC		14	10	17	19	19	G 3/8	G 3/8	-	500	152	10	-
05060170CC		14	10	17	19	19	G 3/8	G 3/8	-	700	188	10	-
05060199CC		14	10	17	19	19	G 3/8	G 3/8	-	1000	242	10	-

05060225CC	M 3/8 - F 1/2	18	10	17	19	23	G 3/8	G 1/2	-	250	109	-	20
05060230CC		18	10	17	19	23	G 3/8	G 1/2	-	300	118	-	20
05060235CC		18	10	17	19	23	G 3/8	G 1/2	-	350	127	-	20
05060240CC		18	10	17	19	23	G 3/8	G 1/2	-	400	136	10	-
05060250CC		18	10	17	19	23	G 3/8	G 1/2	-	500	154	10	-
05060270CC		18	10	17	19	23	G 3/8	G 1/2	-	700	190	10	-
05060299CC		18	10	17	19	23	G 3/8	G 1/2	-	1000	244	10	-

05060325CC	M 1/2 - F 3/8	14	10	21	19	19	G 1/2	G 3/8	-	250	114	-	20
05060330CC		14	10	21	19	19	G 1/2	G 3/8	-	300	123	-	20
05060335CC		14	10	21	19	19	G 1/2	G 3/8	-	350	132	-	20
05060340CC		14	10	21	19	19	G 1/2	G 3/8	-	400	141	10	-
05060350CC		14	10	21	19	19	G 1/2	G 3/8	-	500	159	10	-
05060370CC		14	10	21	19	19	G 1/2	G 3/8	-	700	195	10	-
05060399CC		14	10	21	19	19	G 1/2	G 3/8	-	1000	249	10	-

05060425CC	M 1/2 - F 1/2	18	10	21	19	23	G 1/2	G 1/2	-	250	116	-	20
05060430CC		18	10	21	19	23	G 1/2	G 1/2	-	300	125	-	20
05060435CC		18	10	21	19	23	G 1/2	G 1/2	-	350	136	-	20
05060440CC		18	10	21	19	23	G 1/2	G 1/2	-	400	143	10	-
05060450CC		18	10	21	19	23	G 1/2	G 1/2	-	500	161	10	-
05060470CC		18	10	21	19	23	G 1/2	G 1/2	-	700	197	10	-
05060499CC		18	10	21	19	23	G 1/2	G 1/2	-	1000	251	10	-



TUBETTO IN RAME CROMATO

Tubetto con flangia ricavata, raccordo a compressione, cartuccia a 3 pezzi, maschio prolungato e rosetta scorrevole.

CODICE	RACCORDI	A	B	C	D	E	F	G	H	L			
05070125CC	MPR 3/8 - F 3/8	14	10	17	19	19	G 3/8	G 3/8	60	250	125	-	20
05070130CC		14	10	17	19	19	G 3/8	G 3/8	60	300	134	-	20
05070135CC		14	10	17	19	19	G 3/8	G 3/8	60	350	143	-	20
05070140CC		14	10	17	19	19	G 3/8	G 3/8	60	400	152	10	-
05070150CC		14	10	17	19	19	G 3/8	G 3/8	60	500	170	10	-
05070170CC		14	10	17	19	19	G 3/8	G 3/8	60	700	206	10	-
05070199CC		14	10	17	19	19	G 3/8	G 3/8	60	1000	260	10	-

05070225CC	MPR 3/8 - F 1/2	18	10	17	19	23	G 3/8	G 1/2	60	250	127	-	20
05070230CC		18	10	17	19	23	G 3/8	G 1/2	60	300	136	-	20
05070235CC		18	10	17	19	23	G 3/8	G 1/2	60	350	145	-	20
05070240CC		18	10	17	19	23	G 3/8	G 1/2	60	400	154	10	-
05070250CC		18	10	17	19	23	G 3/8	G 1/2	60	500	172	10	-
05070270CC		18	10	17	19	23	G 3/8	G 1/2	60	700	208	10	-
05070299CC		18	10	17	19	23	G 3/8	G 1/2	60	1000	262	10	-

05070325CC	MPR 1/2 - F 3/8	14	10	21	19	19	G 1/2	G 3/8	60	250	135	-	20
05070330CC		14	10	21	19	19	G 1/2	G 3/8	60	300	144	-	20
05070335CC		14	10	21	19	19	G 1/2	G 3/8	60	350	153	-	20
05070340CC		14	10	21	19	19	G 1/2	G 3/8	60	400	162	10	-
05070350CC		14	10	21	19	19	G 1/2	G 3/8	60	500	180	10	-
05070370CC		14	10	21	19	19	G 1/2	G 3/8	60	700	216	10	-
05070399CC		14	10	21	19	19	G 1/2	G 3/8	60	1000	270	10	-

05070425CC	MPR 1/2 - F 1/2	18	10	21	19	23	G 1/2	G 1/2	60	250	137	-	20
05070430CC		18	10	21	19	23	G 1/2	G 1/2	60	300	146	-	20
05070435CC		18	10	21	19	23	G 1/2	G 1/2	60	350	155	-	20
05070440CC		18	10	21	19	23	G 1/2	G 1/2	60	400	164	10	-
05070450CC		18	10	21	19	23	G 1/2	G 1/2	60	500	182	10	-
05070470CC		18	10	21	19	23	G 1/2	G 1/2	60	700	218	10	-
05070499CC		18	10	21	19	23	G 1/2	G 1/2	60	1000	272	10	-



TUBETTO IN RAME RICOTTO E CROMATO

Tubetto dritto senza flangiatura.

CODICE	RACCORDI	A	B	C	D	E	F	G	H	L			
05421000	Ø 10	-	10	-	-	-	-	-	-	1000	200	10	-
05421200	Ø 12	-	12	-	-	-	-	-	-	1000	222	10	-
05421400	Ø 14	-	14	-	-	-	-	-	-	1000	258	10	-

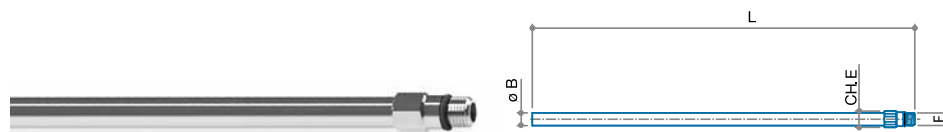

TUBETTO IN RAME

Tubetto rame cromato con raccordo maschio.

05012230	Ø 10 - M 10 x 1	-	10	-	-	12	M 10 x 1	-	-	300	66	10	-
05012240		-	10	-	-	12	M 10 x 1	-	-	400	87	10	-
05012260		-	10	-	-	12	M 10 x 1	-	-	600	126	10	-

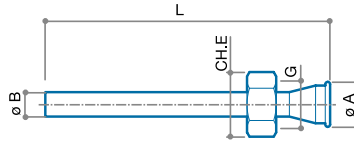

TUBETTO IN RAME CROMATO

Tubetto con flangia ricavata e dado.

CODICE	RACCORDI	A	B	C	D	E	F	G	H	L			
05051720	Ø 10 - F 3/8	14	10	-	-	19	-	G 3/8	-	200	53	10	50
05051725		14	10	-	-	19	-	G 3/8	-	250	62	10	50
05051730		14	10	-	-	19	-	G 3/8	-	300	71	10	50
05051735		14	10	-	-	19	-	G 3/8	-	350	80	10	50
05051740		14	10	-	-	19	-	G 3/8	-	400	89	10	-
05051750		14	10	-	-	19	-	G 3/8	-	500	107	10	-
05051770		14	10	-	-	19	-	G 3/8	-	700	143	10	-
05051799		14	10	-	-	19	-	G 3/8	-	1000	197	10	-

05052120	Ø 10 - F 1/2	18	10	-	-	23	-	G 1/2	-	200	55	10	50
05052125		18	10	-	-	23	-	G 1/2	-	250	64	10	50
05052130		18	10	-	-	23	-	G 1/2	-	300	73	10	50
05052135		18	10	-	-	23	-	G 1/2	-	350	82	10	50
05052140		18	10	-	-	23	-	G 1/2	-	400	91	10	-
05052150		18	10	-	-	23	-	G 1/2	-	500	109	10	-
05052170		18	10	-	-	23	-	G 1/2	-	700	145	10	-
05052199		18	10	-	-	23	-	G 1/2	-	1000	199	10	-

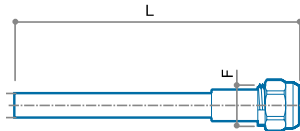

TUBETTO IN RAME RICOTTO E CROMATO

Tubetto con raccordo a compressione e cartuccia a 3 pezzi.

CODICE	RACCORDI	A	B	C	D	E	F	G	H	L			
05100030CC	Ø 10 - RCC 3/8	-	10	-	-	19	G 3/8	-	-	300	86	10	50

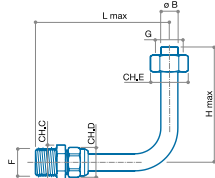

CURVA IN RAME CROMATO

Curva completa di nipplo e raccordo a compressione, con cartuccia a 3 pezzi.

CODICE	RACCORDI	A	B	C	D	E	F	G	H	L			
05422112	M 1/2 - F 1/2	-	12	21	19	23	G 1/2	G 1/2	20	250	160	2	80
05422114		-	14	21	19	23	G 1/2	G 1/2	20	250	184	2	80

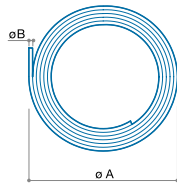

ROTOLO IN RAME RICOTTO E CROMATO

Rotolo di tubo rame pieghevole.

CODICE	RACCORDI	A	B	C	D	E	F	G	H	L			
05401000	Ø 10	350	10	-	-	-	-	-	-	5000	920	-	1
05401200	Ø 12	350	12	-	-	-	-	-	-	5000	1120	-	1

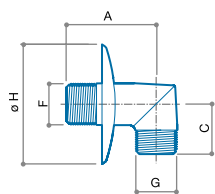

CURVETTA FISSA 90°

Curvetta in ottone cromato per doccia con rosetta scorrevole in ottone cromato.

CODICE	RACCORDI	A	B	C	D	E	F	G	H	L			
85620001	M 1/2 - M 1/2	45	-	25	-	-	G 1/2	G 1/2	68	-	50	10	100
85620002	M 1/2 - M 1/2	45	-	25	-	-	G 1/2	G 1/2	55	-	50	25	200

CURVETTE E SQUADRETTE SOTTOLAVABO



Le curvette e le squadrette sottolavabo Luxor spa vengono utilizzate per facilitare il collegamento tra i tubetti rame e la rete idrica. Questi articoli trovano maggiore utilizzo nelle applicazioni scoperte, dove i collegamenti restano visibili anche dopo l'installazione.

Applicazioni:

- Lavabi aperti, con collegamenti a vista, senza coperture
- Bidet aperti, con collegamenti a vista, senza coperture
- Applicazioni personalizzate con ingombri specifici
- Ogni collegamento generico dei tubetti rame

Le curvette sottolavabo Luxor Spa sono realizzate per il collegare le cannette in rame alla rete idrica.

Questa serie di articoli è stata progettata con interessanti accorgimenti tecnici che permettono agli utilizzatori una rapida e semplice installazione essendo regolabili in profondità e orientabili in angolazione.

La serie di curvette e squadrette sottolavabo Luxor Spa è corredata da accessori come raccordi a compressione, riduzioni e rosette copri foro.

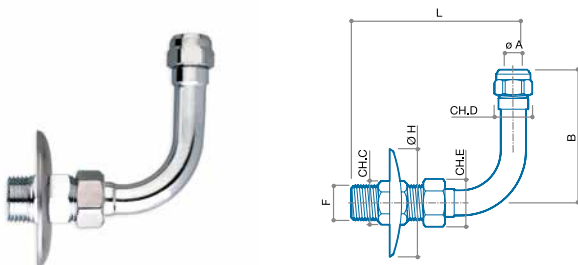

CURVETTA FISSA 90°

Squadretta in rame cromato per tubo \varnothing 10 mm con rosetta scorrevole e cartuccia a 3 pezzi.

CODICE	RACCORDI	A	B	C	D	E	F	G	H	L			
05391700CC	MPR 3/8 - RCC 3/8	10	78	21	19	23	G 3/8	-	60	82	130	10	100
05392100CC	MPR 1/2 - RCC 3/8	10	78	21	19	23	G 1/2	-	60	82	134	10	100

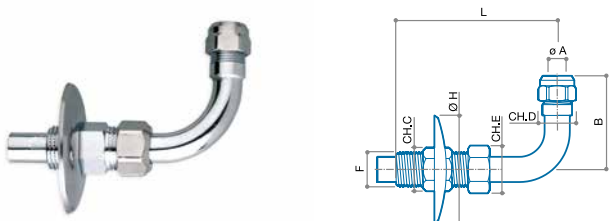

CURVETTA SFILABILE 90°

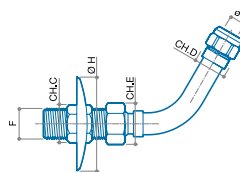

Squadretta in rame cromato, per tubo \varnothing 10 mm con rosetta scorrevole e cartuccia a 3 pezzi.

CODICE	RACCORDI	A	B	C	D	E	F	G	H	L			
05392115CC	MPR 1/2 - RCC 3/8	10	60	21	19	23	G 1/2	-	60	120	154	10	100



CURVETTA ORIENTABILE CON SNODO

Squadretta in rame cromato per tubo \varnothing 10 mm con rosetta scorrevole e cartuccia a 3 pezzi.

CODICE	RACCORDI	A	B	C	D	E	F	G	H	L			
05392125CC	MPR 1/2 - RCC 3/8	10	-	21	19	23	G 1/2	-	60	-	158	10	100

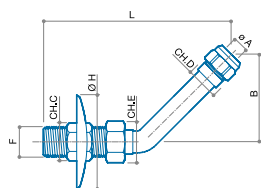

CURVETTA FISSA 45°

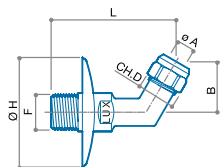

Squadretta in rame cromato per tubo \varnothing 10 mm con rosetta scorrevole e cartuccia a 3 pezzi.

CODICE	RACCORDI	A	B	C	D	E	F	G	H	L			
05391735CC	MPR 3/8 - RCC 3/8	10	60	21	19	23	G 3/8	-	60	120	134	10	100
05392135CC	MPR 1/2 - RCC 3/8	10	60	21	19	23	G 1/2	-	60	120	138	10	100



SQUADRETTA FISSA 60°

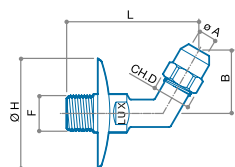

Squadretta in ottone stampato cromato per tubo \varnothing 10 mm con rosetta scorrevole e cartuccia a 3 pezzi.

CODICE	RACCORDI	A	B	C	D	E	F	G	H	L			
05142101CC	MPR 1/2 - RCC 3/8	10	29	-	19	-	G 1/2	-	60	70	98	10	100



SQUADRETTA FISSA 60° DADO ALTO

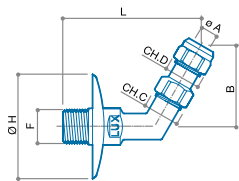

Squadretta in ottone stampato cromato per tubo \varnothing 10 mm con rosetta scorrevole e cartuccia a 3 pezzi dado alto.

CODICE	RACCORDI	A	B	C	D	E	F	G	H	L			
05142102CC	MPR 1/2 - RCC 3/8	10	35	-	19	-	G 1/2	-	60	72	105	10	100



SQUADRETTA FISSA 60° CON PROLUNGA

Squadretta in ottone stampato cromato per tubo \varnothing 10 mm con rosetta scorrevole, cartuccia a 3 pezzi e prolunga.

CODICE	RACCORDI	A	B	C	D	E	F	G	H	L			
05152101CC	MPR 1/2 - RCC 3/8	10	48	19	19	-	G 1/2	-	60	82	124	10	100

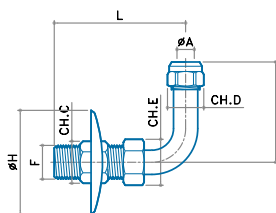

CURVETTA FISSA 90°

Curvetta in ottone cromato per tubo \varnothing 10 mm con rosetta scorrevole e cartuccia a 3 pezzi.

CODICE	RACCORDI	A	B	C	D	E	F	G	H	L			
05391710CC	MPR 3/8 - RCC 3/8	10	57	21	19	23	G 3/8	-	60	76	138	10	100
05392110CC	MPR 1/2 - RCC 3/8	10	57	21	19	23	G 1/2	-	60	76	138	10	100

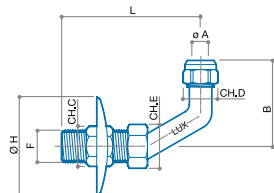

SQUADRETTA FISSA 90°

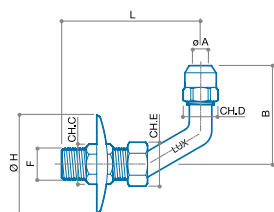

Squadretta in ottone stampato cromato per tubo \varnothing 10 mm con rosetta scorrevole e cartuccia a 3 pezzi.

CODICE	RACCORDI	A	B	C	D	E	F	G	H	L			
05391750CC	MPR 3/8 - RCC 3/8	10	55	21	19	23	G 3/8	-	60	78	144	10	100
05392150CC	MPR 1/2 - RCC 3/8	10	55	21	19	23	G 1/2	-	60	78	144	10	100



SQUADRETTA FISSA 90° DADO ALTO

Squadretta in ottone stampato cromato per tubo \varnothing 10 mm con rosetta scorrevole e cartuccia 3 pezzi dado alto.

CODICE	RACCORDI	A	B	C	D	E	F	G	H	L			
05392160CC	MPR 1/2 - RCC 3/8	10	62	21	19	23	G 1/2	-	60	78	151	10	100

RACCORDI A COMPRESSIONE

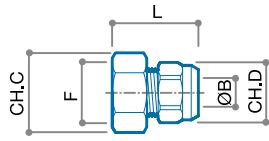

RACCORDO FEMMINA A COMPRESSIONE

Raccordo in ottone cromato per collegamento tubetti rame \varnothing 10 mm e \varnothing 12 mm.

CODICE	RACCORDI	A	B	C	D	E	F	G	H	L			
Cartuccia a tre pezzi													
05301710CC	F 3/8 - RCC 3/8	-	10	20	19	-	G 3/8	-	-	30	40	30	-
05302110CC	F 1/2 - RCC 3/8	-	10	24	19	-	G 1/2	-	-	30	45	30	-
Ogiva teflon													
05301712	F 3/8 - RCO 3/8	-	12	20	19	-	G 3/8	-	-	30	29	30	-
05302112	F 1/2 - RCO 3/8	-	12	24	19	-	G 1/2	-	-	30	40	30	-

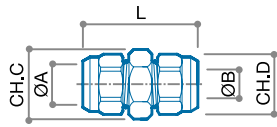

RACCORDO NIPPLO A COMPRESSIONE

Raccordo in ottone cromato per collegamento tubetti rame \varnothing 10 mm e \varnothing 12 mm.

CODICE	RACCORDI	A	B	C	D	E	F	G	H	L			
Cartuccia a tre pezzi													
05291710CC	RCC 3/8 - RCC 3/8	10	10	17	-	-	-	-	-	40	55	30	-
Ogiva teflon													
05291712	RCO 1/2 - RCO 3/8	12	12	17	-	-	-	-	-	40	44	30	-

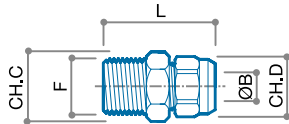

RACCORDO MASCHIO A COMPRESSIONE

Raccordo in ottone cromato per collegamento tubetti rame.

CODICE	RACCORDI	A	B	C	D	E	F	G	H	L			
Cartuccia a tre pezzi													
05321710CC	M 3/8 - RCC 3/8	-	10	17	19	-	G 3/8	-	-	40	45	30	-
05322110CC	M 1/2 - RCC 3/8	-	10	21	19	-	G 1/2	-	-	40	50	30	-
Ogiva teflon													
05321712	M 3/8 - RCO 3/8	-	12	17	19	-	G 3/8	-	-	40	35	30	-
05322112	M 1/2 - RCO 3/8	-	12	21	19	-	G 1/2	-	-	40	46	30	-
05322114	M 1/2 - RCO 1/2	-	14	21	19	-	G 1/2	-	-	40	56	20	-

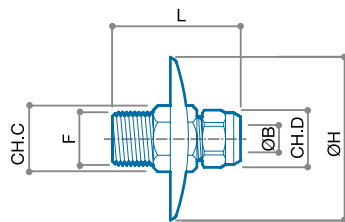

RACCORDO MASCHIO PROLUNGATO A COMPRESSIONE

Raccordo in ottone cromato con rosetta scorrevole per collegamento tubetti rame.

CODICE	RACCORDI	A	B	C	D	E	F	G	H	L			
05311701CC	MPR 3/8 - RCC 3/8	-	10	17	19	-	G 3/8	-	60	48	63	20	-
05312101CC	MPR 1/2 - RCC 3/8	-	10	21	19	-	G 1/2	-	60	48	73	20	200

ROSETTE

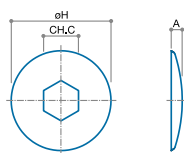
**ROSETTA CON FORO ESAGONALE ϕ 60**

Rosetta scorrevole in acciaio inox ϕ 60 mm con foro esagonale.

CODICE	RACCORDI	A	B	C	D	E	F	G	H	L			
30011700CF	G 3/8	6	-	17	-	-	-	-	60	-	9	10	-
30012100CF	G 1/2	6	-	21	-	-	-	-	60	-	8	10	-

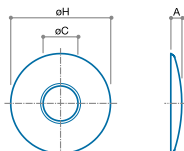

**ROSETTA CON FORO ROTONDO ϕ 60**

Rosetta in acciaio inox ϕ 60 mm con foro rotondo.

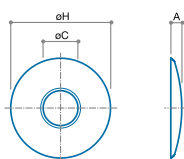
CODICE	RACCORDI	A	B	C	D	E	F	G	H	L			
30031700CF	G 3/8	6	-	17	-	-	-	-	60	-	9	50	-
30032100CF	G 1/2	6	-	21	-	-	-	-	60	-	8	50	-
30032700CF	G 3/4	6	-	27	-	-	-	-	60	-	7	-	50
30033400CF	G 1"	6	-	34	-	-	-	-	60	-	6	-	50

**ROSETTA CON FORO ROTONDO ϕ 55**

Rosetta scorrevole in ottone cromato ϕ 55 mm con foro rotondo.

CODICE	RACCORDI	A	B	C	D	E	F	G	H	L			
30051700CF	G 3/8	6	-	17	-	-	-	-	55	-	7	50	-
30052100CF	G 1/2	6	-	21	-	-	-	-	55	-	6	50	-

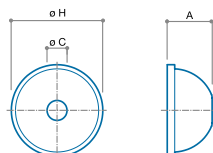

**ROSETTA A CAMPANA ϕ 55**

Rosetta a campana in acciaio inox ϕ 55 mm.

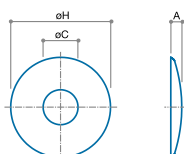
CODICE	RACCORDI	A	B	C	D	E	F	G	H	L			
05260010CF	ϕ 10	27	-	10	-	-	-	-	55	-	14	-	50
05260012CF	ϕ 12	27	-	12	-	-	-	-	55	-	13	-	50
05260014CF	ϕ 14	27	-	14	-	-	-	-	55	-	12	-	50

**ROSETTA CON ALETTE ϕ 57**

Rosetta scorrevole in acciaio inox ϕ 57 mm con aletta.

CODICE	RACCORDI	A	B	C	D	E	F	G	H	L			
30152100CF	G 1/2	8	-	21	-	-	-	-	57	-	9	50	-





6 / RUBINETTI

RUBINETTI



I rubinetti di intercettazione Luxor Spa sono prodotti di alta qualità che trovano spazio in diversi campi di applicazione: dal consolidato utilizzo sottolavabo al collegamento delle cassette scarico WC passando per la connessione delle lavatrici e delle lavastoviglie.

Ai rubinetti di intercettazione Luxor Spa si possono collegare sia tubetti in rame cromato che tubi flessibili. I rubinetti Luxor Spa sono versatili, sicuri e facili da installare.

CAMPI DI APPLICAZIONE



lavabi



bidet



cassette di scarico



lavastoviglie



lavatrici

GAMMA

La gamma di rubinetti Luxor Spa copre ogni tipo di applicazione idrosanitaria e soddisfa i bisogni degli utilizzatori: versatili, facili da installare e garantiti nel tempo.

I rubinetti Luxor Spa possono avere la chiusura a vite oppure a sfera, il tappo di ispezione e il filtro, i raccordi di collegamento orientabili.

Tutti i rubinetti Luxor Spa sono verificati a pressione per garantirne la corretta tenuta. I rubinetti Luxor Spa sono corredate da accessori come raccordi a compressione, riduzioni e rosette copri foro.

**Starx**

Rubinetti a vite con filtro

**Deltax**

Rubinetti a vite senza filtro

**Spheralux**

Rubinetti sottolavabo a sfera

**Serie 50TH**

Rubinetti sottolavabo d'arredo

**Serie SC**

Rubinetti per cassetta scarico

**Serie K**

Rubinetti per elettrodomestici



RUBINETTI

6.1 / STARX

STARX

RUBINETTI A VITONE CON FILTRO



I rubinetti a vitone con filtro serie STARX sono prodotti di alta qualità che trovano spazio in diversi campi di applicazione oltre al consolidato utilizzo sottolavabo.

Possono essere collegati sia tubetti in rame cromato che tubi flessibili: i rubinetti STARX sono versatili, sicuri e facili da installare.

CARATTERISTICHE TECNICHE

		
Max temperatura	Max pressione	Materiale
90 °C	10 bar	CW617N
		
Manopola	Collaudo	Istruzioni di installazione
ABS	100%	Pag. 469

CAMPI DI APPLICAZIONE



lavabi



bidet

EASY-OUT
Facile sostituzione
del sistema
di filtraggio

NUOVO DESIGN
Ottimizzazione
estetica
e funzionale

**DOPPIO
O-RING**
Filettatura protetta
e massima tenuta
garantita



**VITONE
IN NYLON**
Evita il deposito di
calcare e impurità
dell'acqua

VITONE IN NYLON

Il vitone è realizzato in Nylon (Poliammide 6.6). Oltre alle ottime qualità igieniche, il vitone possiede elevate proprietà meccaniche che gli permettono di lavorare senza alcuna alterazione di funzionamen-

to ad alte e basse temperature, e gli permettono di resistere alle sollecitazioni di trazione, torsione e urto a cui potrebbe essere sottoposto il rubinetto durante il suo normale utilizzo.

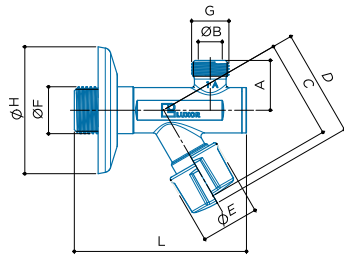
LA GAMMA



S 19

Rubinetto sottolavabo a vitone con filtro e rosetta scorrevole.

CODICE	MISURA	A	B	C	D	E	F	G	H	L	M	N	P			
70502100	G 1/2 - G 3/8	22	10	44	47,5	25,6	G 1/2	G 3/8	56	76	-	-	-	141	10	100

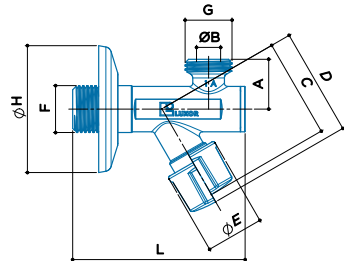

S 20

Rubinetto sottolavabo a vitone con filtro e rosetta scorrevole.

CODICE	MISURA	A	B	C	D	E	F	G	H	L	M	N	P			
70512100	G 1/2 - G 1/2	22	10	44	47,5	25,6	G 1/2	G 1/2	56	76	-	-	-	144	10	100

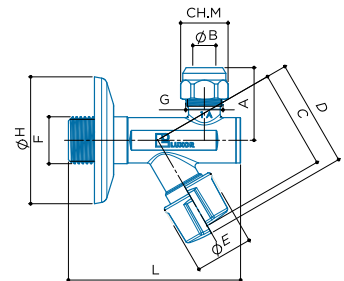

S 23

Rubinetto sottolavabo a vitone con filtro, rosetta scorrevole e cartuccia a 3 pezzi.

CODICE	MISURA	A	B	C	D	E	F	G	H	L	M	N	P			
70502101CC	G 1/2 - G 3/8	32	10	44	47,5	25,6	G 1/2	G 3/8	56	76	19	-	-	156	10	100

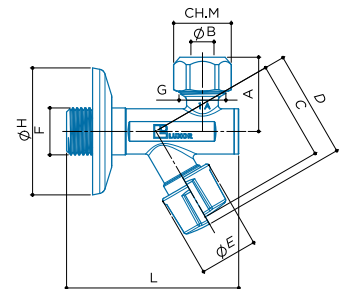

S 24

Rubinetto sottolavabo a vitone con filtro e rosetta scorrevole e ogiva in teflon.

CODICE	MISURA	A	B	C	D	E	F	G	H	L	M	N	P			
70512101	G 1/2 - G 1/2	33	10	44	47,5	25,6	G 1/2	G 1/2	56	76	23	-	-	169	10	100

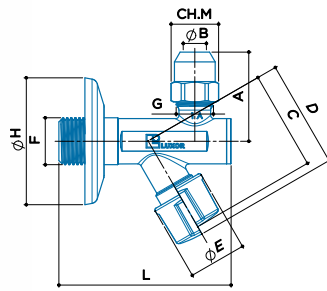

S 27

Rubinetto sottolavabo a vitone con filtro, rosetta scorrevole e cartuccia a 3 pezzi dado alto.

CODICE	MISURA	A	B	C	D	E	F	G	H	L	M	N	P			
70502102CC	G 1/2 - G 3/8	40	10	44	47,5	25,6	G 1/2	G 3/8	56	76	19	-	-	162	10	100

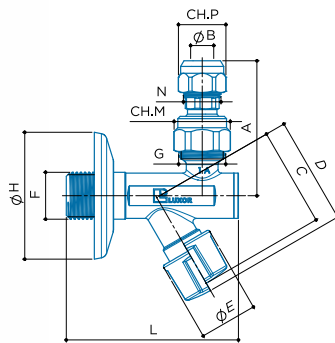

S 30

Rubinetto sottolavabo a vitone con filtro, rosetta scorrevole e cartuccia a 3 pezzi a uscita orientabile.

CODICE	MISURA	A	B	C	D	E	F	G	H	L	M	N	P			
70512111CC	G 1/2 - G 3/8	60	10	44	47,5	25,6	G 1/2	G 1/2	56	76	23	G 3/8	19	198	10	100

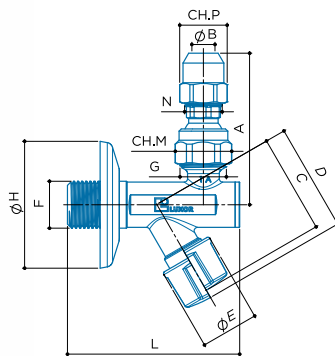

S 31

Rubinetto sottolavabo a vitone con filtro, rosetta scorrevole e cartuccia a 3 pezzi dado alto a uscita orientabile.

CODICE	MISURA	A	B	C	D	E	F	G	H	L	M	N	P			
70512112CC	G 1/2 - G 3/8	67	10	44	47,5	25,6	G 1/2	G 1/2	56	76	23	G 3/8	19	205	10	100

DIAGRAMMA DI PORTATA

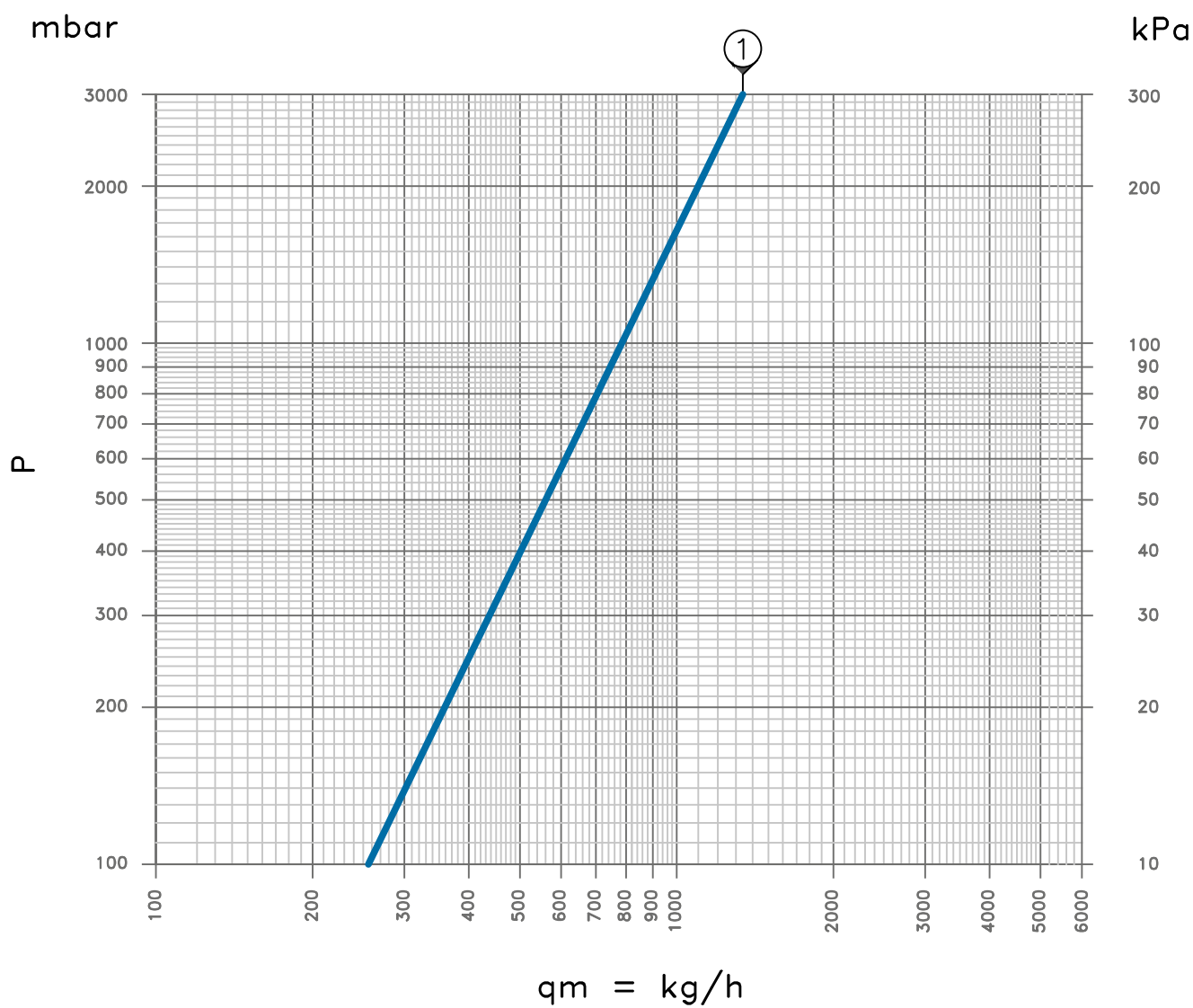

ARTICOLI	CODICE	Kv
S 19	70502100	0,75
S 20	70512100	
S 23	70502101CC	
S 24	70512101	
S 27	70502102CC	
S 30	70512111CC	
S 31	70512112CC	



RUBINETTI

6.2 / DELTAX

DELTAX

RUBINETTI A VITONE SENZA FILTRO



I rubinetti a vitone Luxor Spa offrono tutta la qualità e la garanzia del prodotto Made in Italy. La gamma di prodotti comprende rubinetti con filtro, corpi a dimensione compatta

e raccordi di uscita direzionabili per favorirne il collegamento in ogni condizione di lavoro.

CARATTERISTICHE TECNICHE



Max temperatura

90 °C



Max pressione

10 bar



Materiale

CW617N



Manopola

ABS



Collaudo

100%



Istruzioni di
installazione

Pag. 469

CAMPI DI APPLICAZIONE



lavabi



bidet

VITONE IN NYLON

Il vitone è realizzato in Nylon (Poliammide 6.6). Oltre alle ottime qualità igieniche, il vitone possiede elevate proprietà meccaniche che gli permettono di lavorare senza alcuna alterazione di funzionamen-

to ad alte e basse temperature, e gli permettono di resistere alle sollecitazioni di trazione, torsione e urto a cui potrebbe essere sottoposto il rubinetto durante il suo normale utilizzo.

LA GAMMA

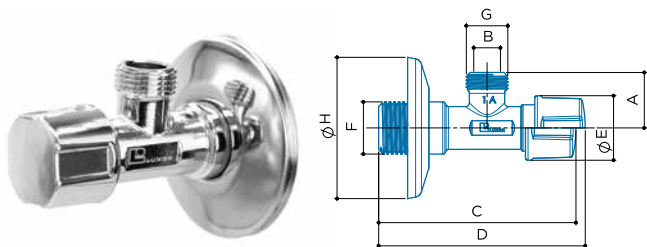

S 2

Rubinetto sottolavabo a vitone senza filtro con rosetta scorrevole.

CODICE	MISURA	A	B	C	D	E	F	G	H	L	M			
70202100	G 1/2 - G 3/8	22	10	78,2	81,9	25,6	G1/2	G3/8	56	-	-	93	10	100

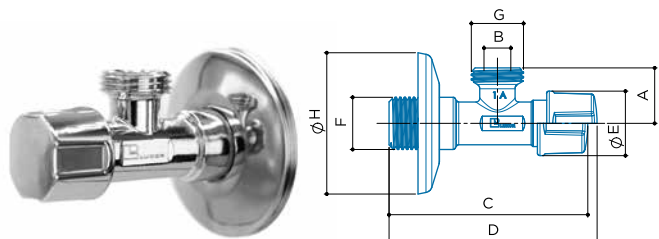

S 3

Rubinetto sottolavabo a vitone senza filtro con rosetta scorrevole.

CODICE	MISURA	A	B	C	D	E	F	G	H	L	M			
70212100	G 1/2 - G 1/2	22	10	78,2	81,9	25,6	G1/2	G1/2	56	-	-	97	10	100

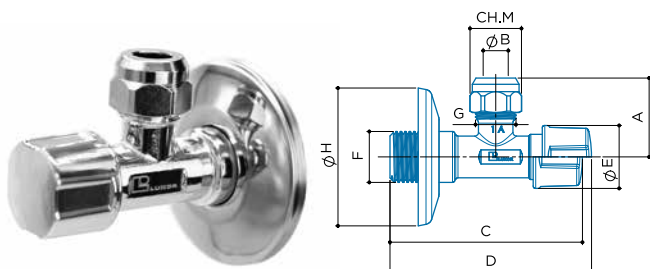

S 7

Rubinetto sottolavabo a vitone senza filtro con rosetta scorrevole e cartuccia a 3 pezzi.

CODICE	MISURA	A	B	C	D	E	F	G	H	L	M			
70202101CC	G 1/2 - G 3/8	32	10	78,2	81,9	25,6	G1/2	G3/8	56	-	19	108	10	100

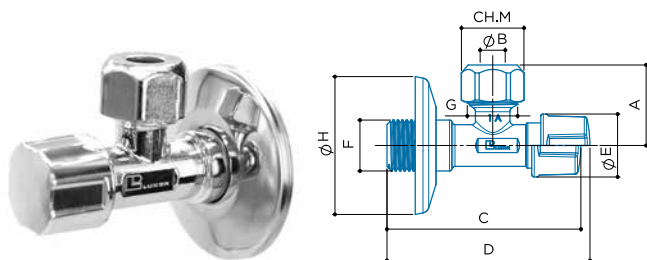

S 8

Rubinetto sottolavabo a vitone senza filtro con rosetta scorrevole e ogiva in teflon.

CODICE	MISURA	A	B	C	D	E	F	G	H	L	M			
70212101	G 1/2 - G 1/2	32,8	10	78,2	81,9	25,6	G1/2	G1/2	56	-	23	122	10	100

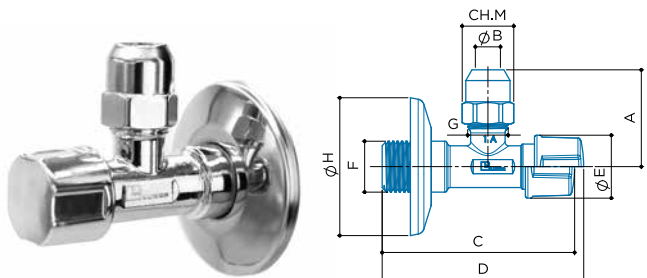

S 12

Rubinetto sottolavabo a vitone senza filtro con rosetta scorrevole e cartuccia a 3 pezzi dado alto.

CODICE	MISURA	A	B	C	D	E	F	G	H	L	M			
70202102CC	G 1/2 - G 3/8	39	10	78,2	81,9	25,6	G1/2	G3/8	56	-	19	113	10	100

DIAGRAMMA DI PORTATA

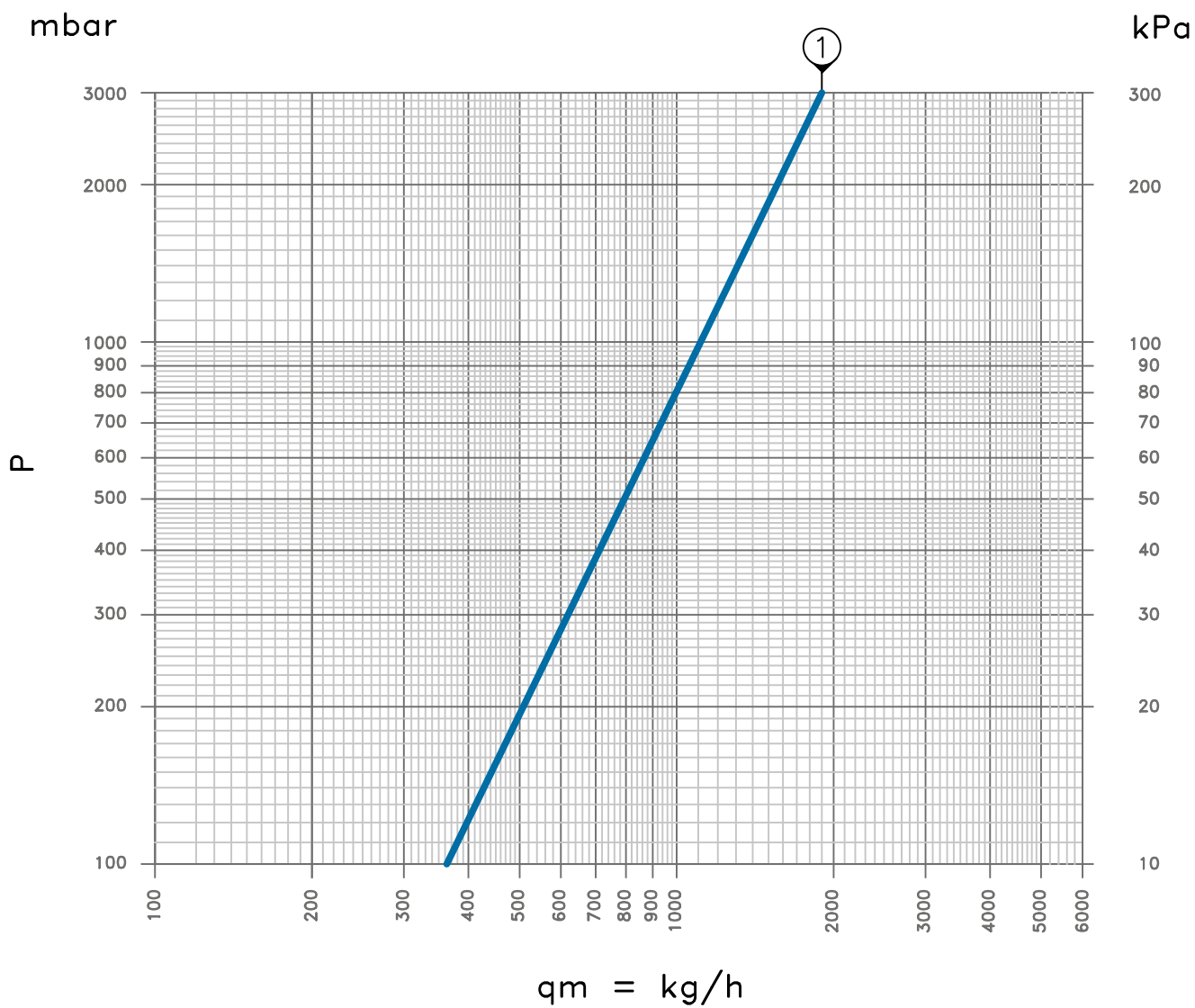

ARTICOLI	CODICE	Kv
S 2	70202100	1,1
S 3	70212100	
S 7	70202101CC	
S 8	70212101	
S 12	70202102CC	



RUBINETTI

6.3 / SPHERALUX

SPHERALUX

RUBINETTI SOTTOLAVABO A SFERA



I rubinetti a sfera offrono la praticità della classica chiusura a corsa corta unita alla qualità e alla garanzia del prodotto Made in Italy.

La gamma di articoli comprende rubinetti standard e con uscita direzionabile attraverso raccordi snodabili che facilitano la loro installazione.

CARATTERISTICHE TECNICHE



Max temperatura

90 °C



Max pressione

10 bar



Materiale

CW617N



Manopola

ABS



Collaudo

100%



Istruzioni di
installazione
Pag. 469

CAMPI DI APPLICAZIONE



lavabi



bidet

SFERA E ASTA DI COMANDO

La sfera e l'asta di comando sono realizzate in ottone CW614N a basso contenuto di piombo in conformità alla normativa Europea UNI EN12164 che ne stabilisce le caratteristiche di composizione chimica. La tenuta della sfera è realizzata attraverso guarnizioni in PTFE vergine, mentre l'asta di comando utilizza a tale scopo

un sistema di sicurezza a doppio o-ring in EPDM, che preserva le sue caratteristiche di tenuta e di resistenza meccanica nel tempo. Tutte le guarnizioni utilizzate, PTFE ed EPDM, sono realizzate in conformità alle più rigide normative internazionali in materia di sanità e di sicurezza ambientale.

FILTRO

Il filtro è realizzato in acciaio inox AISI 304 resistente all'azione degli agenti atmosferici e all'ossidazione. L'apposito tappo di ispezione è dotato di un comodo intaglio per facilitare le operazioni di apertura/chiusura e per semplificare l'operazione di pulizia del filtro.

MANIGLIA

La maniglia, con la comoda chiusura a quarto di giro, è realizzata in ABS con finitura cromata e possiede elevate proprietà meccaniche che gli permettono di resistere alle sollecitazioni di trazione, torsione e urto a cui potrebbe essere sottoposto il rubinetto durante il suo normale utilizzo.



TENUTA GARANTITA

Tutti i rubinetti a sfera Luxor Spa vengono accuratamente controllati a pressione al 100% in linea durante la fase di assemblaggio degli articoli per garantirne la tenuta ed evitare possibili perdite dopo l'installazione finale.

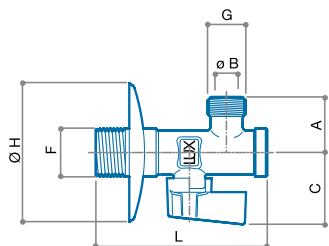
LA GAMMA



**V 35**

Rubinetto sottolavabo a sfera con filtro e rosetta scorrevole.

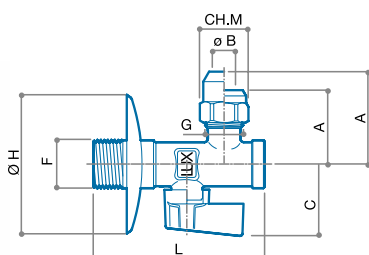
CODICE	MISURA	A	B	C	D	E	F	G	H	L	M	N	P			
70902100	G 1/2 - G 3/8	24	10	31	-	-	G 1/2	G 3/8	56	74	-	-	-	128	10	100

**V 43**

Rubinetto sottolavabo a sfera con filtro, con rosetta scorrevole e cartuccia a 3 pezzi dado alto.

CODICE	MISURA	A	B	C	D	E	F	G	H	L	M	N	P			
70902102CC	G 1/2 - G 3/8	40	10	31	-	-	G 1/2	G 3/8	56	74	19	-	-	148	10	100

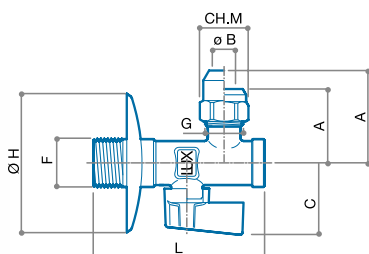
**V 39**

Rubinetto sottolavabo a sfera con filtro, con rosetta scorrevole e cartuccia a 3 pezzi.

CODICE	MISURA	A	B	C	D	E	F	G	H	L	M	N	P			
70902101CC	G 1/2 - G 3/8	32	10	31	-	-	G 1/2	G 3/8	56	74	19	-	-	142	10	100

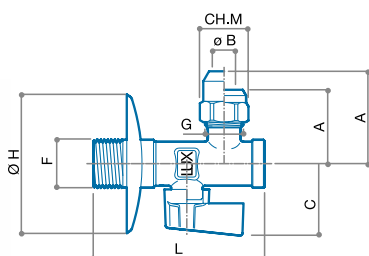

**V 40**

Rubinetto sottolavabo a sfera con filtro, con rosetta scorrevole e ogiva in teflon.

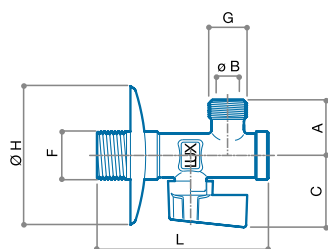
CODICE	MISURA	A	B	C	D	E	F	G	H	L	M	N	P			
70912101	G 1/2 - G 1/2	32	10	31	-	-	G 1/2	G 1/2	56	74	23	-	-	162	10	100



**V 36**

Rubinetto sottolavabo a sfera con filtro e rosetta scorrevole.

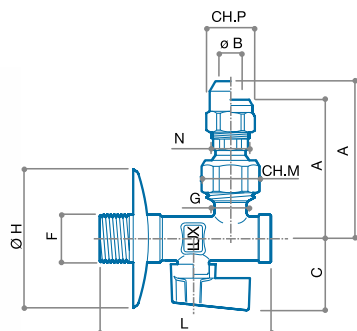
CODICE	MISURA	A	B	C	D	E	F	G	H	L	M	N	P			
70912100	G 1/2 - G 1/2	24	10	31	-	-	G 1/2	G 1/2	56	74	-	-	-	134	10	100



**V 46**

Rubinetto sottolavabo a sfera con filtro, con rosetta scorrevole e cartuccia a 3 pezzi a uscita orientabile.

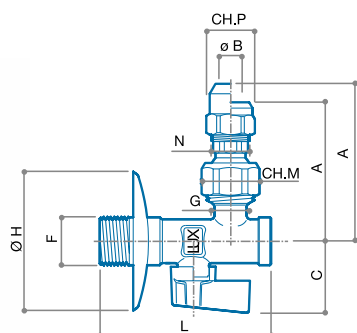
CODICE	MISURA	A	B	C	D	E	F	G	H	L	M	N	P			
7091211CC	G 1/2 - G 3/8	62	10	31	-	-	G 1/2	G 1/2	56	74	23	G 3/8	19	192	10	100

**V 47**

Rubinetto sottolavabo a sfera con filtro, con rosetta scorrevole e cartuccia a 3 pezzi dado alto a uscita orientabile.

CODICE	MISURA	A	B	C	D	E	F	G	H	L	M	N	P			
70912112CC	G 1/2 - G 3/8	68	10	31	-	-	G 1/2	G 1/2	56	74	23	G 3/8	19	198	10	100

ISTRUZIONI DI INSTALLAZIONE PER RUBINETTI STARX, DELTAX E SPHERALUX

Per il corretto montaggio dei collegamenti rigidi sottolavabo è necessario attenersi alla sequenza sotto indicata, verificando scrupolosamente il verso di assemblaggio di cartuccia e guarnizioni.

È quindi importante collegare per prima cosa il nipplo con rosetta alla rete idrica, inserire correttamente le eventuali guarnizioni tra la curvetta e il nipplo, inserire la cartuccia RCC

all'interno del dado di serraggio facendo attenzione al verso di inserimento e infine serrare il raccordo al tubetto.

Attenzione:

- **Verificare il corretto verso della cartuccia;**
- **Coppia di serraggio consigliata da 25 a 30 Nm max.**



DIAGRAMMA DI PORTATA



ARTICOLI	CODICE	Kv
V 35	70902100	1,20
V 36	70912100	
V 39	70902101CC	
V 40	70912101	
V 43	70902102CC	
V 46	70912111CC	
V 47	70912112CC	

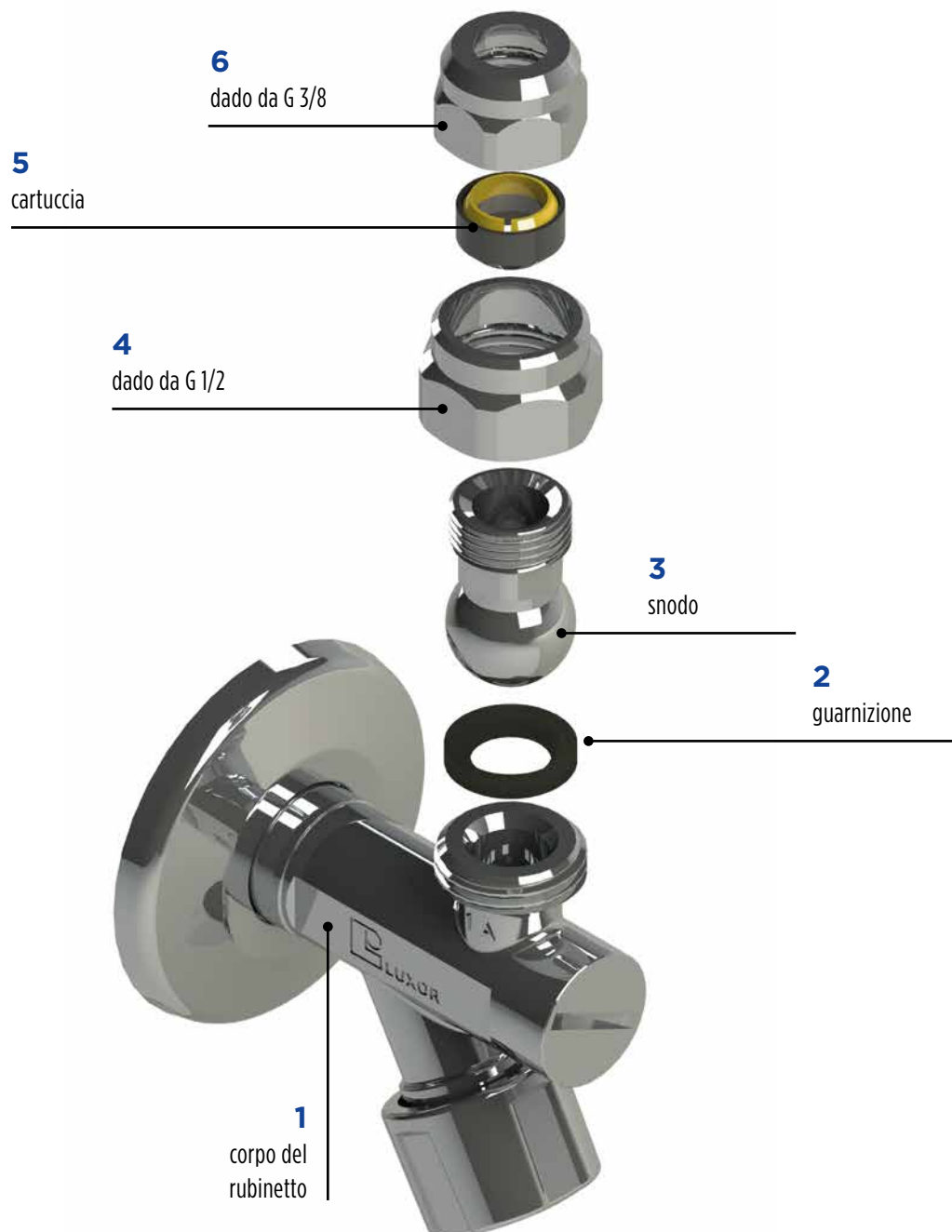
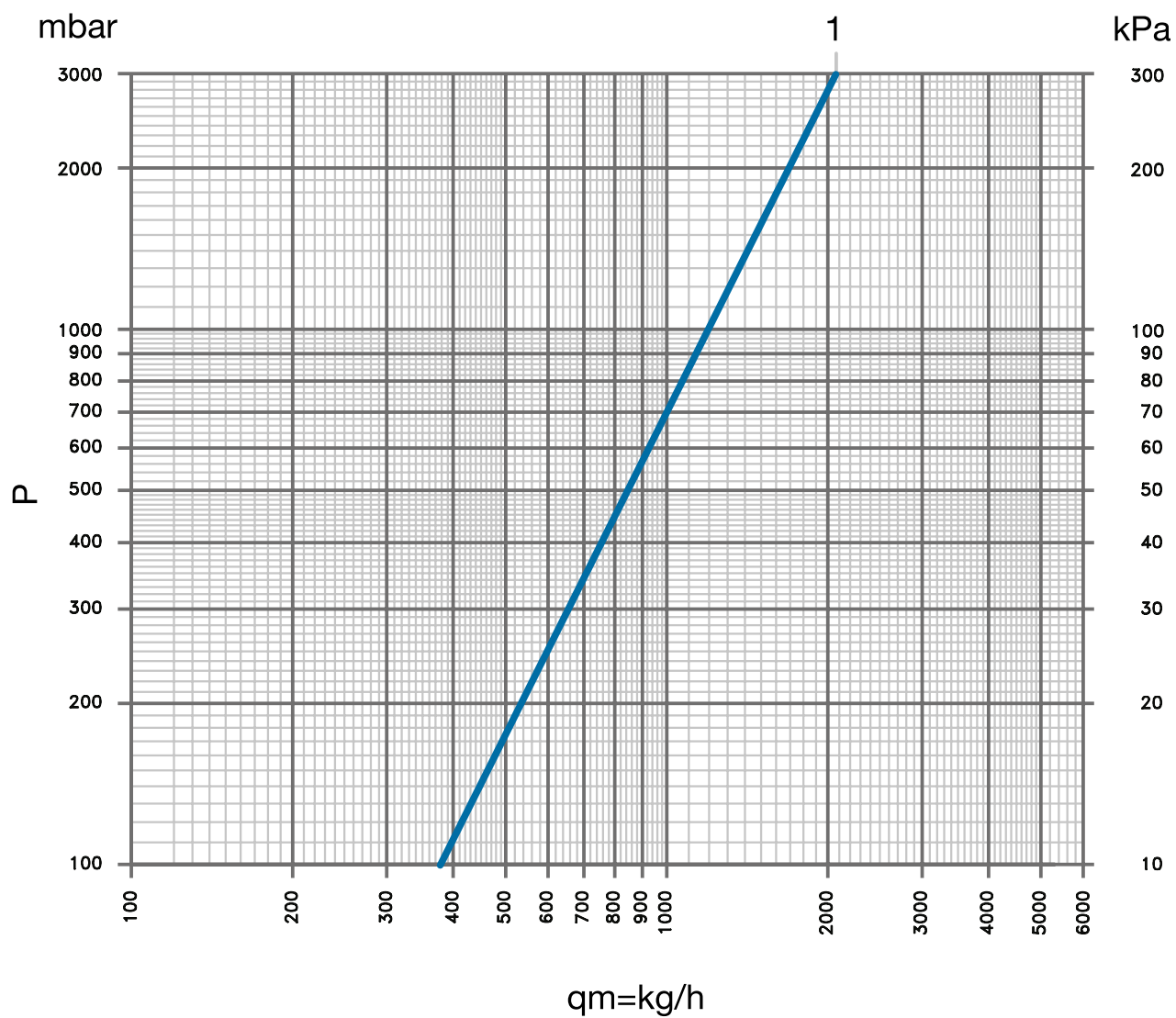

RUBINETTI

6.4 / SERIE 50th

SERIE 50th

RUBINETTI SOTTOLAVABO D'ARREDO



Tutta la gamma di rubinetti Serie 50th viene prodotta con finitura cromata a telaio, garantendo ai prodotti la massima resistenza nel tempo. I corpi dei rubinetti vengono realizzati utilizzando ottone CW617N a basso contenuto di piombo. Il

vitone è realizzato in ottone CW614N e tutte le guarnizioni sono prodotte in EPDM perossidico. I rubinetti Serie 50th sono sottoposti ad doppio processo di lucidatura che permette l'ottenimento di una finitura eccellente.

CARATTERISTICHE TECNICHE



Max temperatura
90 °C



Max pressione
10 bar



Materiale
CW617N



Manopola
ABS

CAMPI DI APPLICAZIONE



lavabi



bidet

LA GAMMA



CROMATO



NERO

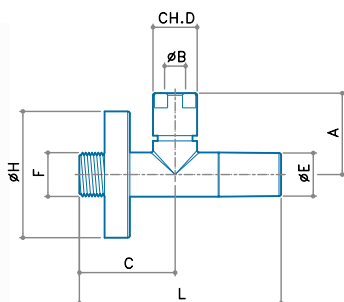

S 53

Kit composto da: 2 rubinetti dritti sottolavabo con asta fissa, rosetta scorrevole e cartuccia 3 pezzi.

CODICE	MISURA	FINITURA	A	B	C	D	E	F	G	H	L	M			
7095210ICC	G 1/2 - G 3/8	CROMATO	39	10	46	19	21	G 1/2	-	60	96	-	400	1	12
7095210CCN	G 1/2 - G 3/8	NERO	39	10	46	19	21	G 1/2	-	60	96	-	400	1	12



CROMATO



NERO

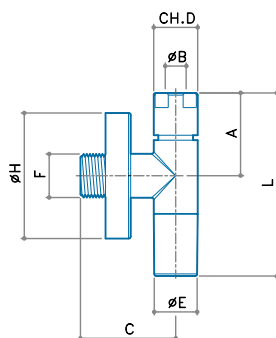

S 54

Kit composto da: 2 rubinetti a squadra sottolavabo con asta fissa, rosetta scorrevole e cartuccia 3 pezzi.

CODICE	MISURA	FINITURA	A	B	C	D	E	F	G	H	L	M			
7097210ICC	G 1/2 - G 3/8	CROMATO	39	10	46	19	21	G 1/2	-	60	88	-	388	1	12
7097210CCN	G 1/2 - G 3/8	NERO	39	10	46	19	21	G 1/2	-	60	88	-	388	1	12

DIAGRAMMA DI PORTATA

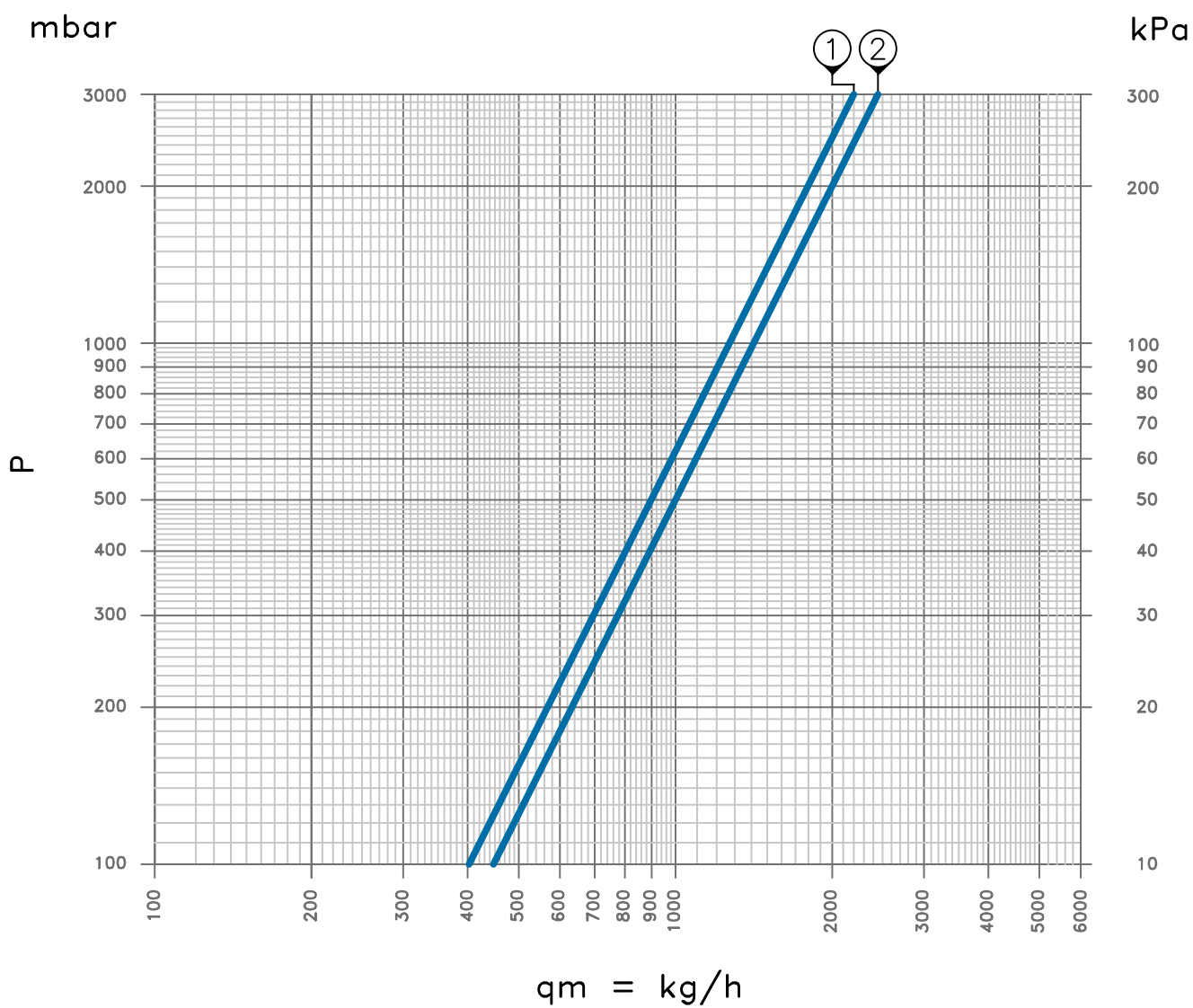

ARTICOLI	CODICE	CURVA	Kv
S 53	70952101CC	1	1,4
	70952101CCN		
S 54	70972101CC	2	1,45
	70972101CCN		



LUXOR®

RUBINETTI

6.5 / SERIE SC

SERIE SC

RUBINETTI PER CASSETTA SCARICO



La gamma di questi rubinetti viene utilizzata prevalentemente per collegare le cassette di scarico WC alla rete idrica. La gamma è composta, oltre che dal compatto rubinetto a vitone, da kit di assemblaggio con tubetti rame, raccordi a com-

pressione, nipli di collegamento e rosette. La completezza e la versatilità di questi prodotti facilita e semplifica le operazioni di installazione nelle più svariate condizioni di utilizzo.

CARATTERISTICHE TECNICHE



Max temperatura

90 °C



Max pressione

10 bar



Materiale

CW617N



Manopola

ABS



Collaudo

100%

CAMPI DI APPLICAZIONE



cassette di scarico

VITONE IN NYLON

Il vitone è realizzato in Nylon (Poliammide 6.6). Oltre alle ottime qualità igieniche, il vitone possiede elevate proprietà meccaniche che gli permettono di lavorare senza alcuna alterazione di funzionamen-

to ad alte e basse temperature, e gli permettono di resistere alle sollecitazioni di trazione, torsione e urto a cui potrebbe essere sottoposto il rubinetto durante il suo normale utilizzo.

TUBETTI

I tubetti di collegamento vengono realizzati utilizzando rame disossidato al fosforo qualità Cu-DHP con composizione chimica Cu 99,9% min, le cui caratteristiche meccaniche, dimensioni e tolleranze sono rispondenti alla norma EN1057 e norme ad essa collegate. Tutti i particolari realizzati vengono rigorosamente lavati in vasche ad ultrasuoni con agenti neutri che permettono di eliminare sostanze di lavorazione residue.

MANIGLIA

La maniglia ergonomica è realizzata in ABS con finitura cromata e possiede elevate proprietà meccaniche che gli permettono di resistere alle sollecitazioni di trazione, torsione e urto a cui potrebbe essere sottoposto il rubinetto durante il suo normale utilizzo.

ROSETTE

Le rosette sono realizzate in acciaio inox AISI 430 resistente all'azione degli agenti atmosferici, alle soluzioni alcaline degli acidi organici e all'ossidazione fino ad alte temperature.

LA GAMMA

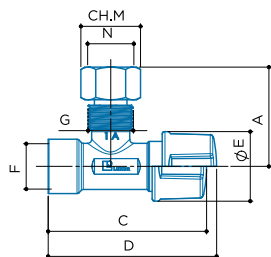

S 60

Rubinetto per cassetta di scarico.

CODICE	MISURA	A	B	C	D	E	F	G	H	L	N			
70600100	F 3/8 - M 3/8 - F 3/8	36	-	58,2	61,9	25,6	G 3/8	G 3/8	-	-	G 3/8	79	10	100

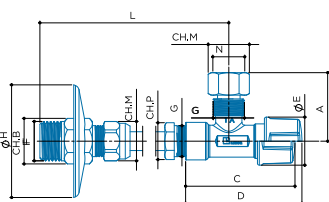

S 61

Rubinetto per cassetta di scarico con rosetta scorrevole, tubetto in rame cromato da 20cm e cartuccia a 3 pezzi.

CODICE	MISURA	A	B	C	D	E	F	G	H	L	M	N	P			
70600020CC	MPR 1/2 - F 3/8	36	21	58,2	61,9	25,6	G 1/2	G 3/8	60	208	19	G 3/8	17	206	10	80

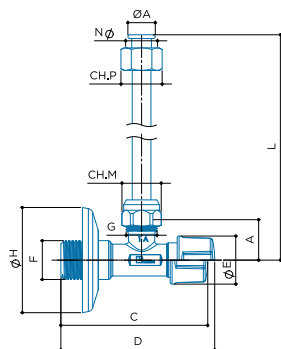

S 62

Rubinetto per cassetta di scarico con rosetta scorrevole, tubetto in rame cromato da 25cm e cartuccia a 3 pezzi.

CODICE	MISURA	A	B	C	D	E	F	G	H	L	M	N	P			
70610030CC	M 1/2 - F 3/8	14	-	78,2	81,9	25,6	G 1/2	G 3/8	60	258	19	G 3/8	19	175	10	80

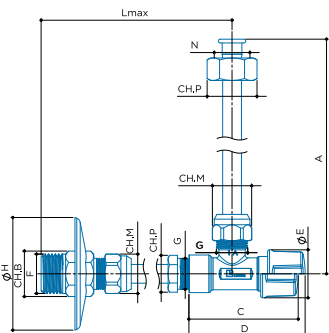

S 63

Rubinetto per cassetta di scarico con rosetta scorrevole, tubetti in rame cromati da 20 cm e cartuccia a 3 pezzi.

CODICE	MISURA	A	B	C	D	E	F	G	H	L	M	N	P			
70610025CC	MPR 1/2 - F 1/2	258	21	58,2	61,9	25,6	G 1/2	G 3/8	60	208	19	G 1/2	23	257	10	80
70611025CC	MPR 1/2 - F 3/8	258	21	58,2	61,9	25,6	G 1/2	G 3/8	60	208	19	G 3/8	19	255	10	60

DIAGRAMMA DI PORTATA

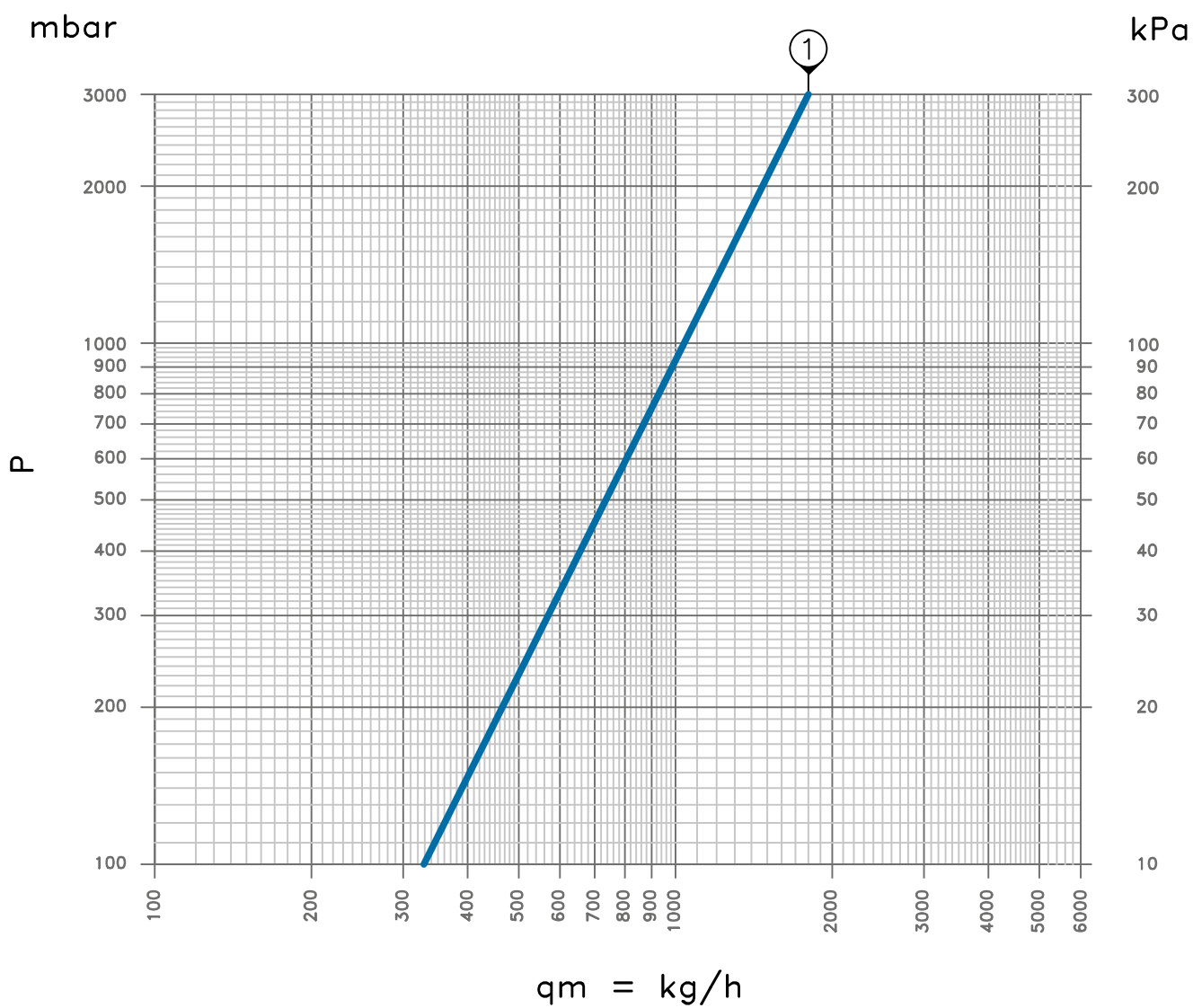

ARTICOLI	CODICE	Kv
S 60	70600100	1,10
S 61	70600020CC	
S 62	70601030CC	
S 63	70610025CC	
	70611025CC	



RUBINETTI

6.6 / SERIE K

SERIE K

RUBINETTI PER ELETTRODOMESTICI



La gamma dei rubinetti multiuso comprende una varietà di articoli utilizzabili per i più disparati impieghi.

Gli articoli comprendono rubinetti a vitone, a sfera, a più derivazioni, per collegamento lavatrice, lavastoviglie e sottolavabo.

CARATTERISTICHE TECNICHE



Max temperatura

90 °C



Max pressione

10 bar



Materiale

CW617N



Manopola

ABS

CAMPI DI APPLICAZIONE



lavastoviglie



lavatrici



lavabi

MANIGLIA

La maniglia è realizzata in ABS con finitura cromata e possiede elevate proprietà meccaniche che gli permettono di resistere alle sollecitazioni di trazione, torsione e urto a cui potrebbe essere sottoposto il rubinetto durante il suo normale utilizzo.

ROSETTE

Le rosette sono realizzate in acciaio inox AISI 430 resistente all'azione degli agenti atmosferici, alle soluzioni alcaline degli acidi organici e all'ossidazione fino ad alte temperature.

LA GAMMA

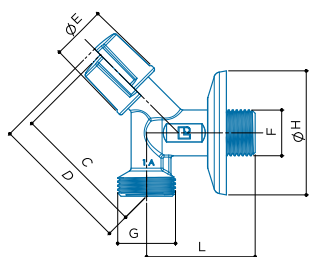

S 70

Rubinetto per lavatrice a vitone con rosetta scorrevole e maniglia inclinato a 45°. Senza valvola di ritorno.

CODICE	MISURA	A	B	C	D	E	F	G	H	L	M			
70352105	G 1/2 - G 3/4	-	-	60	65	25,6	G1/2	G3/4	56	49	-	142	10	100

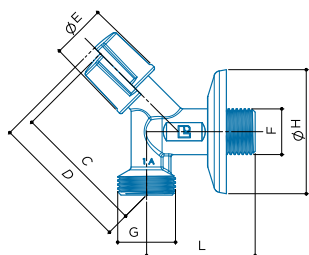

S 71

Rubinetto per lavatrice a vitone con rosetta scorrevole e maniglia inclinato a 45° con valvola di non ritorno per evitare il riflusso delle acque inquinate nella rete idrica.

CODICE	MISURA	A	B	C	D	E	F	G	H	L	M			
70352102	G 1/2 - G 3/4	-	-	60	65	25,6	G1/2	G3/4	56	49	-	144	10	100

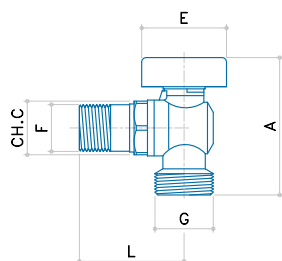

S 72

Rubinetto per lavatrice a sfera con maniglia a farfalla.

CODICE	MISURA	A	B	C	D	E	F	G	H	L	M			
70292127	G 1/2 - G 3/4	62	-	22	-	38	G1/2	G3/4	-	47	-	144	10	100

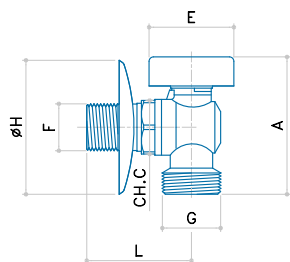

S 73

Rubinetto per lavatrice a sfera con maniglia a farfalla e rosetta scorrevole.

CODICE	MISURA	A	B	C	D	E	F	G	H	L	M			
70302127	G 1/2 - G 3/4	62	-	22	-	38	G1/2	G3/4	56	47	-	152	10	100

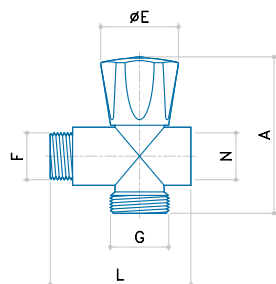

S 74

Rubinetto intermedio a vitone con attacco per lavatrice e maniglia a 6 punte.

CODICE	MISURA	A	E	F	G	L	N			
70312100	G 1/2 - G 1/2 (intermedio) G 3/4 (attacco lavatrice)	70	35	G1/2	G3/4	63	G1/2	174	10	100

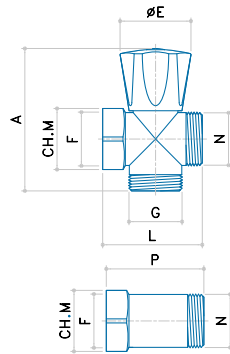

S 75

Rubinetto intermedio a vitone con attacco per lavatrice, maniglia a 6 punte e distanziatore.

CODICE	MISURA	A	B	E	F	G	H	L	M	N	P			
70370000	G 3/4	70	-	35	G3/4	G3/4	-	49	30	G3/4	48	230	10	-

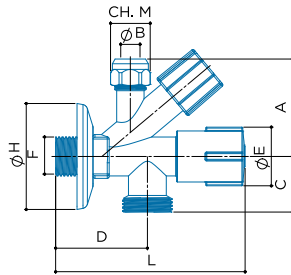

S 76

Rubinetto doppia uscita a vitone con attacco per lavatrice, rosetta scorrevole e cartuccia a 3 pezzi.

CODICE	MISURA	A	B	C	D	E	F	G	H	L	M			
70402101CC	G 3/4 - G 3/8 - G 1/2	53	10	28	49	31	G1/2	G3/4	56	100	19	236	5	50

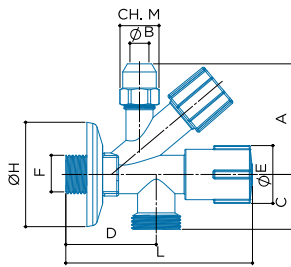

S 77

Rubinetto doppia uscita a vitone con attacco per lavatrice, rosetta scorrevole e cartuccia a 3 pezzi dado alto.

CODICE	MISURA	A	B	C	D	E	F	G	H	L	M			
70402102CC	G 3/4 - G 3/8 - G 1/2	61	10	28	49	31	G1/2	G3/4	56	100	19	244	5	50

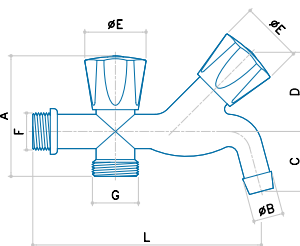

S 78

Rubinetto doppia uscita a vitone con attacco per lavatrice.

CODICE	MISURA	A	B	C	D	E	F	G	H	L	M			
70162100	G 1/2 - G 3/4	69	17	34	45	35	G1/2	G3/4	-	130	-	376	6	-

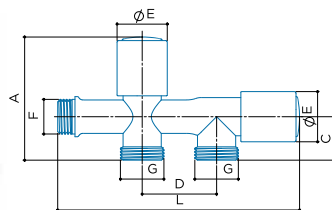

S 79

Rubinetto doppia uscita a vitone con attacco per lavatrice e lavastoviglie.

CODICE	MISURA	A	B	C	D	E	F	G	H	L	M			
70382100	G 1/2 - G 3/4 - G 3/4	74	-	26	45	30	G1/2	G3/4	-	144	-	296	6	-

CARTUCCIA RCC

La cartuccia RCC è la soluzione più sicura e funzionale per la connessione dei rubinetti alle utenze finali. Essendo i tre componenti raccolti in un corpo unico, la cartuccia RCC è la soluzione definitiva ai problemi di installazione dei raccordi a compressione. Non più componenti persi o montati in modo erraneo, ma un solo pezzo che garantisce un'ottima tenuta meccanica e idraulica allo stesso tempo.

La cartuccia è composta da una rondella a stringere in ottone ricotto CW614N con ottime caratteristiche meccaniche di malleabilità, da una guarnizione NBR e da una capsula conte-

nitiva in Nylon a grande tenacità ed elevata resistenza all'urto. Il filtro anticalcare è realizzato in acciaio inox AISI 304 resistente all'azione degli agenti atmosferici e all'ossidazione.

L'apposito tappo di ispezione è dotato di un comodo intaglio per facilitare le operazioni di apertura/chiusura e per semplificare l'operazione di pulizia del filtro. La maniglia ergonomica è realizzata in ABS con finitura cromata e possiede elevate proprietà meccaniche che gli permettono di resistere alle sollecitazioni di trazione, torsione e urto a cui potrebbe essere sottoposto il rubinetto durante il suo normale utilizzo.

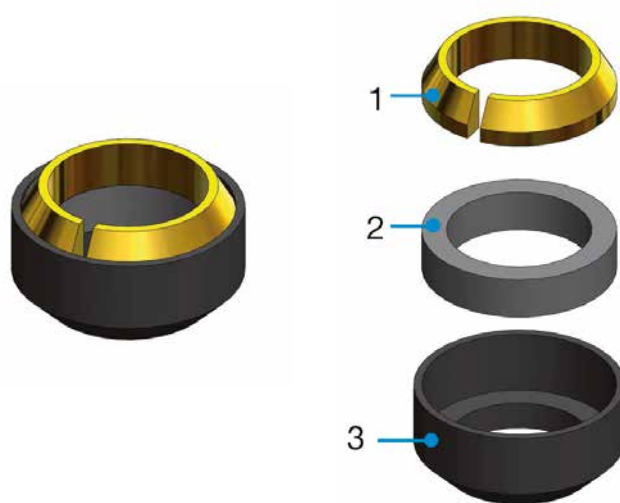

1. Rondella a stringere in ottone CW614N

La rondella in ottone possiede ottime caratteristiche meccaniche grazie al processo di ricottura che migliora la malleabilità del materiale garantendo il corretto accoppiamento tra raccordo e tubo senza esercitare un'eccessiva forza di serraggio.

2. Guarnizione interna in NBR

Campo di utilizzo per temperature fino a 90°C:

le guarnizioni in NBR possiedono buone proprietà meccaniche, bassa deformazione permanente e bassa permeabilità al gas.

3. Cartuccia esterna in Nylon (Poliamide 6.6)

Campo di utilizzo per temperature fino a 90°C:

la cartuccia in Nylon possiede ottime caratteristiche di resistenza meccanica accoppiate a grande tenacità ed elevata resistenza all'urto.

DIAGRAMMA DI PORTATA

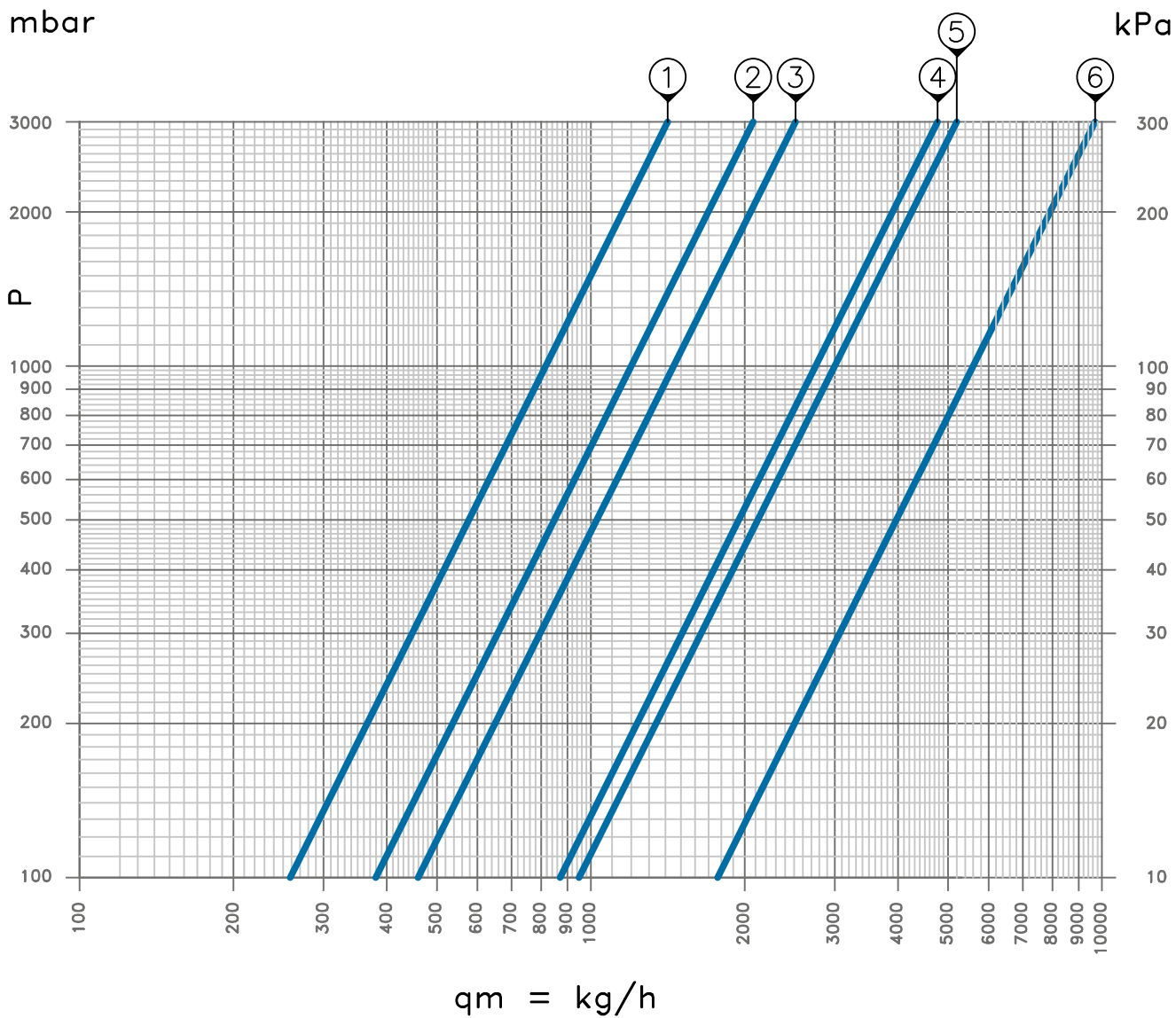

ARTICOLI	CODICE	CURVA	Kv
S 70	70352105	1	0,85
S 71	70352102		
S 76	70402101CC	2	1,20
S 77	70402102CC		
S 72	70292127	3	1,55
S 73	70302127		
S 74	70312100	4	2,75
S 79	70382100		
S 78	70162100	5	3,00
S 75	70370000	6	5,60



RUBINETTI

6.7 / ACCESSORI

ACCESSORI

**RUBINETTI A GALLEGGIANTE
ASTA TONDA**

Rubinetto a galleggiante in ottone serie pesante, 5 coppie.

CODICE	MISURA			
65041700	G 3/8	146	10	-
65042100	G 1/2	168	10	-

**RUBINETTI A GALLEGGIANTE
ASTA PIATTA**

Rubinetto a galleggiante in ottone serie pesante, 5 coppie.

CODICE	MISURA			
65012700	G 3/4	271	1	50
65013400	G 1"	410	1	50
65074200	G 1"1/4	1058	-	10
65074800	G 1"1/2	1385	-	10
65076000	G 2"	1872	-	5

**RUBINETTI A GALLEGGIANTE
SILENZIOSO**

Rubinetto a galleggiante in ottone silenzioso, regolabile con sede e tubo in plastica.

CODICE	MISURA			
65091700	G 3/8	154	10	-
65092100	G 1/2	182	10	-

**RUBINETTI A GALLEGGIANTE
CON SEDE INOX FLOATING**

Rubinetto a galleggiante in ottone con sede inox e tubo in plastica collaudato 9 bar.

CODICE	MISURA			
65131700	G 3/8	152	10	-
65132100	G 1/2	182	10	-

**RUBINETTI A GALLEGGIANTE
PER ALTA PRESSIONE**

Rubinetto a galleggiante in ottone regolabile, per alta pressione (12 bar), con asta piatta e tubo in plastica.

CODICE	MISURA			
65122700	G 3/4	926	-	30
65123400	G 1"	980	-	30
65124200	G 1"1/4	1834	-	10
65124800	G 1"1/2	1880	-	10
65126000	G 2"	3030	-	5

**SNODO E DADO BASSO**

Snodo 3/8 con dado basso.

CODICE	MISURA			
05210000CC	G 1/2 - G 3/8 Ø 10	56	30	-

**SNODO E DADO ALTO**

Snodo 3/8 con dado alto.

CODICE	MISURA			
05220000CC	G 1/2 - G 3/8 Ø 10	62	30	-

**SFERA PIATTA**

Sfera in plastica con filetto per attacco asta tonda.

CODICE	MISURA			
65150000	-	34	10	50

**SFERA TONDA**

Sfera in plastica con attacco scorrevole per asta piatta.

CODICE	MISURA			
65160001	Ø 120	82	5	20
65160002	Ø 180	214	1	10

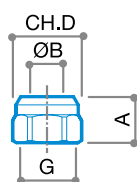

**DADO**

Dado in ottone cromato per raccordi a compressione.

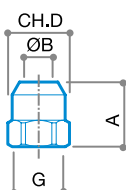
CODICE	RACCORDI	A	B	C	D	E	F	G	H	L			
76171000CF	3/8 - Ø 10	14	10	-	19	-	-	G 3/8	-	-	12	50	-
76171200CF	3/8 - Ø 12	14	12	-	19	-	-	G 3/8	-	-	12	50	-
76211000CF	1/2 - Ø 10	15	10	-	23	-	-	G 1/2	-	-	23	50	-
76211200CF	1/2 - Ø 12	15	12	-	23	-	-	G 1/2	-	-	21	50	-
76211400CF	1/2 - Ø 14	15	14	-	23	-	-	G 1/2	-	-	19	50	-



**DADO ALTO**

Dado alto in ottone cromato per raccordi a compressione.

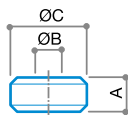
CODICE	RACCORDI	A	B	C	D	E	F	G	H	L			
76171001CF	3/8 - Ø 10	22	10	-	19	-	-	G 3/8	-	-	18	50	-



**OGIVA IN TEFLON**

Guarnizione di tenuta per raccordi a compressione.

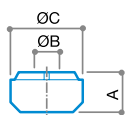
CODICE	RACCORDI	A	B	C	D	E	F	G	H	L			
77171000CF	3/8 - Ø 10	6,5	10	14,5	-	-	-	-	-	-	1	100	-
77171200CF	3/8 - Ø 12	7	12	14,5	-	-	-	-	-	-	2	100	-
77211000CF	1/2 - Ø 10	7,5	10	18,5	-	-	-	-	-	-	1	100	-
77211200CF	1/2 - Ø 12	7,5	12	18,5	-	-	-	-	-	-	2	100	-
77211400CF	1/2 - Ø 14	7,5	14	18,5	-	-	-	-	-	-	2	100	-

**CARTUCCIA 3 PEZZI BASSA**

Guarnizione di tenuta per raccordi a compressione.

CODICE	RACCORDI	A	B	C	D	E	F	G	H	L			
77171002CF	3/8 - Ø 10	8	10	14,5	-	-	-	-	-	-	1	100	-

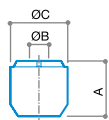

**CARTUCCIA 3 PEZZI ALTA**

Guarnizione di tenuta per raccordi a compressione dado alto.

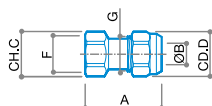
CODICE	RACCORDI	A	B	C	D	E	F	G	H	L			
77171003CF	3/8 - Ø 10	14	10	14,5	-	-	-	-	-	-	2	100	-



**PROLUNGA CROMATA**

Prolunga in ottone femmina-raccordo a compressione con cartuccia a 3 pezzi.

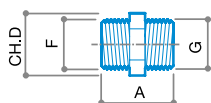
CODICE	RACCORDI	A	B	C	D	E	F	G	H	L			
05160000CC	F 3/8 - RCC 3/8	40	10	19	19	-	G 3/8	G 3/8	-	-	40	30	-



**RACCORDO NIPPOLO CROMATO**

Raccordo in ottone Maschio-Maschio.

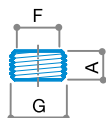
CODICE	RACCORDI	A	B	C	D	E	F	G	H	L			
55021700	M 3/8 x M 3/8	31	-	-	17	-	G 3/8	G 3/8	-	-	31	25	-
55022100	M 1/2 x M 1/2	28	-	-	21	-	G 1/2	G 1/2	-	-	36	25	-

**RIDUZIONE**

Riduzione in ottone Maschio-Femmina.

CODICE	RACCORDI	A	B	C	D	E	F	G	H	L			
55051700	M 1/2 x F 3/8	10	-	-	-	-	G 3/8	G 1/2	-	-	4	100	-
55052100	M 3/4 x F 1/2	11	-	-	-	-	G 1/2	G 3/4	-	-	14	100	-

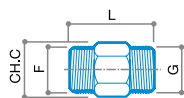

RACCORDO NIPPOLO PROLUNGATO CROMATO

Raccordo in ottone Maschio-Maschio.

CODICE	RACCORDI	A	B	C	D	E	F	G	H	L			
05331721	MP 1/2 x M 3/8	-	-	17	-	-	G 1/2	G 3/8	-	38	50	25	-
05332121	MP 1/2 x M 1/2	-	-	21	-	-	G 1/2	G 1/2	-	38	52	25	-

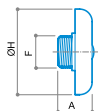

TAPPO CON ROSETTA

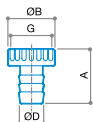

Tappo in ottone con rosetta Ø 55 mm di copertura e vite di fissaggio.

CODICE	RACCORDI	A	B	C	D	E	F	G	H	L			
55072100	M 1/2	23	-	-	-	-	G 1/2	-	55	-	55	20	200



GIRELLO

Ghiera girello con portagomma in ottone nichelato.

CODICE	RACCORDI	A	B	C	D	E	F	G	H	L			
55271500	F 3/4	33	28	-	15	-	-	G 3/4	-	-	24	25	-
55342000	F 1"	40	35	-	20	-	-	G 1"	-	-	38	20	-

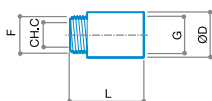

PROLUNGA CROMATA M-F

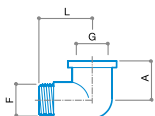

Prolunga in ottone lucido cromato Maschio-Femmina.

CODICE	RACCORDI	A	B	C	D	E	F	G	H	L			
55062110	M 1/2 - F 1/2	-	-	13	24	-	G 1/2	G 1/2	-	20	26	50	-
55062115	M 1/2 - F 1/2	-	-	13	24	-	G 1/2	G 1/2	-	25	32	50	-
55062120	M 1/2 - F 1/2	-	-	13	24	-	G 1/2	G 1/2	-	30	38	50	-
55062125	M 1/2 - F 1/2	-	-	13	24	-	G 1/2	G 1/2	-	35	46	25	-
55062130	M 1/2 - F 1/2	-	-	13	24	-	G 1/2	G 1/2	-	40	52	25	-
55062140	M 1/2 - F 1/2	-	-	13	24	-	G 1/2	G 1/2	-	50	68	25	-
55062150	M 1/2 - F 1/2	-	-	13	24	-	G 1/2	G 1/2	-	60	82	25	-



CURVA 90° CROMATA M-F

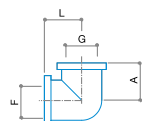

Curva in ottone lucida cromata Maschio-Femmina.

CODICE	RACCORDI	A	B	C	D	E	F	G	H	L			
55131700	M 3/8 - F 3/8	24	-	-	-	-	G 3/8	G 3/8	-	30	58	25	-
55132100	M 1/2 - F 1/2	24	-	-	-	-	G 1/2	G 1/2	-	33	68	25	-
55132700	M 3/4 - F 3/4	30	-	-	-	-	G 3/4	G 3/4	-	41	132	10	-
55133400	M 1" - F 1"	39	-	-	-	-	G 1"	G 1"	-	51	268	10	-



CURVA 90° CROMATA F-F

Curva in ottone lucida cromata Femmina-Femmina.

CODICE	RACCORDI	A	B	C	D	E	F	G	H	L			
55151700	F 3/8 - F 3/8	23	-	-	-	-	G 3/8	G 3/8	-	23	48	25	-
55152100	F 1/2 - F 1/2	24	-	-	-	-	G 1/2	G 1/2	-	24	68	25	-
55152700	F 3/4 - F 3/4	24	-	-	-	-	G 3/4	G 3/4	-	24	112	10	-
55153400	F 1" - F 1"	35	-	-	-	-	G 1"	G 1"	-	35	168	10	-

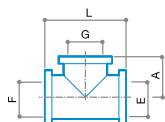

RACCORDO A T CROMATO

Raccordo di derivazione a 3 vie in ottone cromato.

CODICE	RACCORDI	A	B	C	D	E	F	G	H	L			
55171700	F 3/8	24	-	-	-	G 3/8	G 3/8	G 3/8	-	48	102	25	-
55172100	F 1/2	24	-	-	-	G 1/2	G 1/2	G 1/2	-	47	98	25	-
55172700	F 3/4	25	-	-	-	G 3/4	G 3/4	G 3/4	-	49	108	10	-
55173400	F 1"	35	-	-	-	G 1"	G 1"	G 1"	-	67	264	10	-

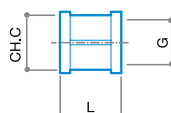

MANICOTTO CROMATO F-F

Raccordo in ottone lucido cromato Femmina-Femmina.

CODICE	RACCORDI	A	B	C	D	E	F	G	H	L			
55191700	F 3/8-F 3/8	-	-	-	-	-	-	G 3/8	-	31	40	25	-
55192100	F 1/2-F 1/2	-	-	24	-	-	-	G 1/2	-	27	44	25	-
55192700	F 3/4-F 3/4	-	-	30	-	-	-	G 3/4	-	33	66	10	-
55193400	F 1"-F 1"	-	-	37	-	-	-	G 1"	-	250	90	10	-

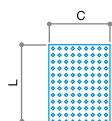

FILTRO INOX

Filtro in acciaio inox per rubinetti a sfera sottolavabo Luxor.

CODICE	RACCORDI	A	B	C	D	E	F	G	H	L			
2903015CF	Ø 13,8	-	-	13,8	-	-	-	-	-	17,5	0,4	50	-



7 / SIFONI

SIFONI



CARATTERISTICHE COSTRUTTIVE

I sifoni Luxor Spa offrono la qualità e l'affidabilità del prodotto Made in Italy. La gamma di articoli, apprezzata dagli installatori per la loro solidità e durata nel tempo, comprende i tipi di sifone comunemente utilizzati per convogliare l'acqua di scarico di lavabo, bidet e lavatrice.

Alcuni tra gli articoli proposti sono conformi a quanto previsto dalla norma UNI EN274 ed in particolare soddisfano il requisito dimensionale relativo alla colonna d'acqua che non deve essere inferiore ai 50 mm.

FINITURA CROMATA

Tutta la gamma viene prodotta con finitura cromata a telaio che garantisce maggiori spessori di ricopertura e di conseguenza una maggiore resistenza all'invecchiamento e alla corrosione, nonché una finitura estetica di livello superiore.

Tale cromatura viene realizzata utilizzando sostanze e processi galvanici conformi alle più rigide normative internazionali in materia di sanità e di sicurezza ambientale.

I corpi dei sifoni vengono realizzati utilizzando ottone CW617N a basso contenuto di piombo in conformità alla norma UNI EN12165 che ne regola la composizione chimica.

I sifoni realizzati da tubo vengono invece prodotti utilizzando ottone CW508L conforme alla norma UNI EN12449. Nella gamma di prodotti sono presenti inoltre sifoni in ABS cromato con ottima durezza superficiale, resistenza chimica agli agenti esterni e resistenza agli urti.

Le rosette, lucidate e cromate, sono realizzate sia in acciaio inox AISI 430 che in ottone e sono in grado di resistere all'azione degli agenti atmosferici e all'ossidazione che si potrebbe formare durante il normale utilizzo.





SIFONI

7.1 / SERIE ST

SERIE ST

SIFONI STANDARD

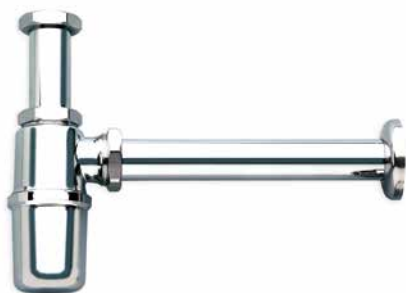

I sifoni Luxor Spa offrono la qualità e l'affidabilità del prodotto Made in Italy.

La gamma di articoli, apprezzata dagli installatori per la loro solidità e durata nel tempo, comprende i tipi di sifone comunemente utilizzati per convogliare l'acqua di scarico di lavabo e bidet.

CARATTERISTICHE TECNICHE



Materiale corpo sifone

CW 617 N - DW UNI-EN 12165:2016



Materiale rosone

AISI 430



Materiale codolo e canotto

CW 508L



Finitura

Cromata

CAMPI DI APPLICAZIONE



lavabi





lavabo cucina

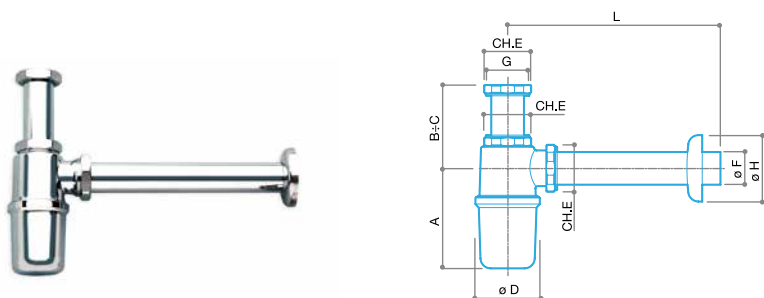

bidet

**SIF 001**



Sifone bottiglia in ottone cromato senza piletta, ispezionabile, con rosone in acciaio inox.

CODICE	MISURA	Ø TUBO x L mm	A	B	C	D	E	F	G	H	L			
93323401	G 1"	26 x 200	80	43	100	55	36	26	G 1"	75	223	434	1	40
93323403		26 x 250	80	43	100	55	36	26	G 1"	75	273	442	1	40
93323404		26 x 250	80	43	140	55	36	26	G 1"	75	273	450	1	40

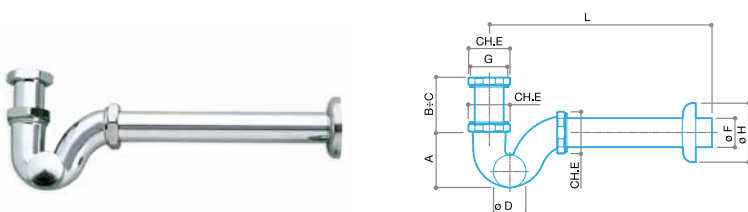
93324201	G 1 1/4	32 x 200	98	50	103	64	44	32	G 1 1/4	75	223	496	1	40
93324203		32 x 250	98	50	103	64	44	32	G 1 1/4	75	273	504	1	40
93324204		32 x 250	98	50	143	64	44	32	G 1 1/4	75	273	512	1	40

**SIF 002**



Sifone "S" per bidet in ottone cromato senza piletta, ispezionabile, con rosone in acciaio inox.

CODICE	MISURA	Ø TUBO x L mm	A	B	C	D	E	F	G	H	L			
93363401	G 1"	26 x 200	50	59	74	30	36	26	G 1"	75	265	356	1	40
93363403		26 x 250	50	59	74	30	36	26	G 1"	75	315	364	1	40
93363404		26 x 250	50	59	114	30	36	26	G 1"	75	315	372	1	40

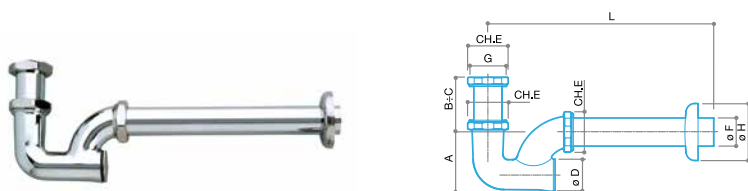
93364201	G 1 1/4	32 x 200	60	47	58	36	44	32	G 1 1/4	75	265	452	1	40
93364203		32 x 250	60	47	58	36	44	32	G 1 1/4	75	315	460	1	40
93364204		32 x 250	60	47	98	36	44	32	G 1 1/4	75	315	468	1	40

**SIF 003**

Sifone colonna per lavabo in ottone cromato senza piletta, ispezionabile, con rosone in acciaio inox.



CODICE	MISURA	Ø TUBO x L mm	A	B	C	D	E	F	G	H	L			
93403401	G 1"	26 x 200	65	53	58	32	36	26	G 1"	75	282	384	1	40
93403403		26 x 250	65	53	58	32	36	26	G 1"	75	332	392	1	40
93403404		26 x 250	65	53	98	32	36	26	G 1"	75	332	400	1	40

93404201	G 1 1/4	32 x 200	67	51	58	36	44	32	G 1 1/4	75	276	458	1	40
93404203		32 x 250	67	51	58	36	44	32	G 1 1/4	75	326	466	1	40
93404204		32 x 250	67	51	98	36	44	32	G 1 1/4	75	326	474	1	40

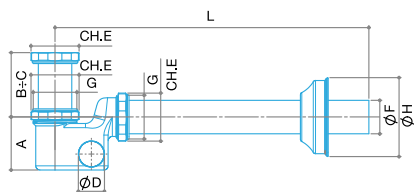
* codolo 120 mm



**SIF 004**

Sifone compatto in ottone cromato senza piletta, ispezionabile, con rosone in acciaio inox.

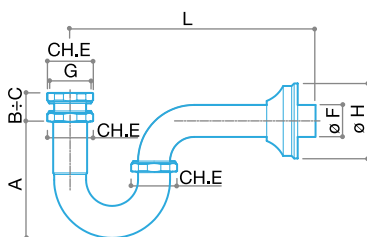
CODICE	MISURA	Ø TUBO x L mm	A	B	C	D	E	F	G	H	L			
93444203	G 1"1/4	32 x 250	51	30	50	25	44	32	G 1"1/4	75	300	571	1	40



**SIF 017**

Sifone per lavabo in tubo di ottone cromato senza piletta, con rosone in ottone cromato.

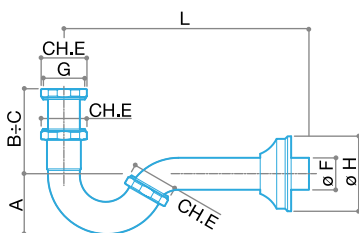
CODICE	MISURA	A	B	C	D	E	F	G	H	L			
93544200	G 1"1/4	118	28	65	-	44	32	G 1"1/4	75	317	400	1	40

**SIF 018**

Sifone per bidet in tubo di ottone cromato senza piletta, con rosone in ottone cromato.

CODICE	MISURA	A	B	C	D	E	F	G	H	L			
93524200	G 1"1/4	62	80	100	-	44	32	G 1"1/4	75	310	396	1	40



SIFONI

7.2 / SERIE PREMIUM

SERIE PREMIUM

SIFONI DI LUSO

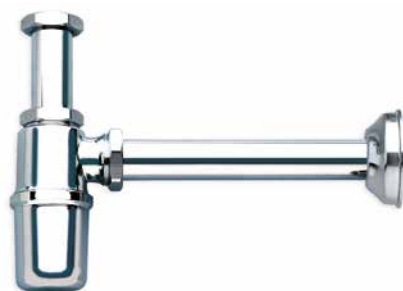

I sifoni Luxor Spa offrono la qualità e l'affidabilità del prodotto Made in Italy.

La gamma di articoli, apprezzata dagli installatori per la loro solidità e durata nel tempo, comprende i tipi di sifone comunemente utilizzati per convogliare l'acqua di scarico di lavabo e bidet.

CARATTERISTICHE TECNICHE



Materiale corpo sifone

CW 617 N - DW UNI-EN 12165:2016



Materiale rosone

CW 508L



Materiale codolo e canotto

CW 508L



Finitura

Cromata

CAMPI DI APPLICAZIONE



lavabi





lavabo cucina

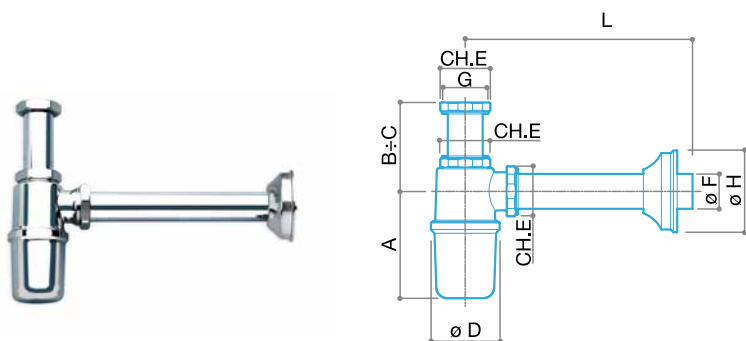

bidet

**SIF 005**



Sifone bottiglia lusso in ottone cromato senza piletta, ispezionabile, con rosone in ottone cromato.

CODICE	MISURA	Ø TUBO x L mm	A	B	C	D	E	F	G	H	L			
93023400	G 1"	26 x 250	80	43	100	55	36	26	G 1"	75	273	438	1	40
93023404		26 x 250	80	43	140	55	36	26	G 1"	75	273	446	1	40

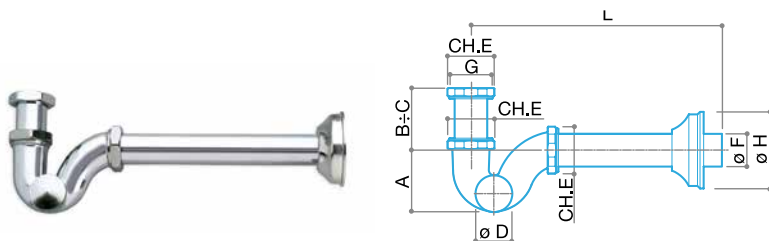
93024200	G 1 1/4	32 x 250	98	50	103	64	44	32	G 1 1/4	75	273	572	1	40
93024204		32 x 250	98	50	143	64	44	32	G 1 1/4	75	273	578	1	40

**SIF 006**



Sifone "S" lusso per bidet in ottone cromato senza piletta, ispezionabile, con rosone in ottone cromato.

CODICE	MISURA	Ø TUBO x L mm	A	B	C	D	E	F	G	H	L			
93163400	G 1"	26 x 250	50	59	74	30	36	26	G 1"	75	315	360	1	40
93163404		26 x 250	50	99	114	30	36	26	G 1"	75	315	368	1	40

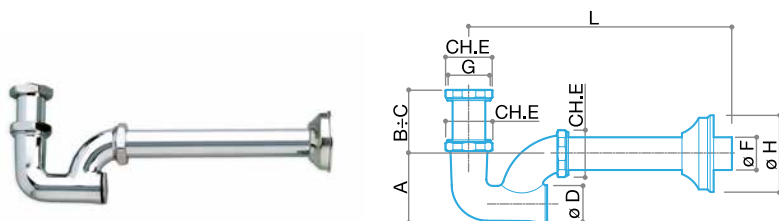
93164200	G 1 1/4	32 x 250	60	47	58	36	44	32	G 1 1/4	75	315	454	1	40
93164204		32 x 250	60	87	98	36	44	32	G 1 1/4	75	315	462	1	40

**SIF 007**

Sifone colonna lusso per lavabo in ottone cromato senza piletta, ispezionabile, con rosone in ottone cromato.

CODICE	MISURA	Ø TUBO x L mm	A	B	C	D	E	F	G	H	L			
93203400	G 1"	26 x 250	65	53	58	32	36	26	G 1"	75	332	388	1	40
93203404		26 x 250	65	93	98	32	36	26	G 1"	75	332	396	1	40

93204200	G 1 1/4	32 x 250	67	51	58	36	44	32	G 1 1/4	75	332	460	1	40
93204204		32 x 250	67	91	98	36	44	32	G 1 1/4	75	332	468	1	40

* codolo 120 mm



SIFONI

7.3 / SERIE PL

SERIE PL

SIFONI IN ABS



I sifoni Luxor Spa offrono la qualità e l'affidabilità del prodotto Made in Italy.

La gamma di articoli, apprezzata dagli installatori per la loro solidità e durata nel tempo, comprende i tipi di sifone comunemente utilizzati per convogliare l'acqua di scarico di lavabo e bidet.

In ogni scatola dei sifoni in ABS è incluso un paio di guanti per una migliore cura e pulizia del sifone in fase di montaggio.

CARATTERISTICHE TECNICHE



Materiale corpo sifone
ABS Cromato



Materiale rosone
ABS Cromato



Materiale codolo e canotto
ABS Cromato



Finitura
Cromata

CAMPI DI APPLICAZIONE



lavabi





lavabo cucina

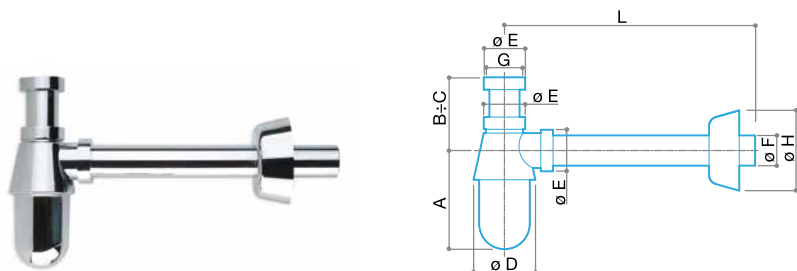

bidet



**SIF 008**

Sifone bottiglia in ABS cromato senza piletta, ispezionabile, con rosone in ABS cromato.

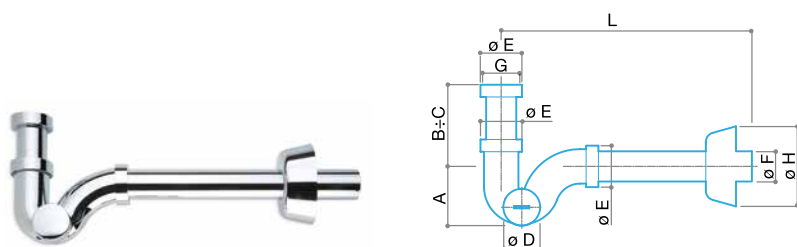
CODICE	MISURA	Ø TUBO x L mm	A	B	C	D	E	F	G	H	L			
96023400	G 1"	26 x 250	84	45	121	61	35	26	G 1"	85	287	202	1	10
* 96024200	G 1 1/4	32 x 250	105	48	128	66	44	32	G 1 1/4	85	293	272	1	10



**SIF 009**

Sifone "S" per bidet in ABS cromato senza piletta, ispezionabile, con rosone in ABS cromato.

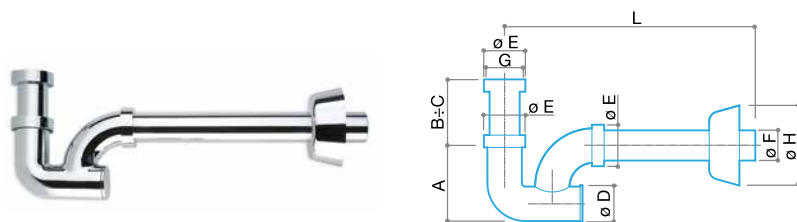
CODICE	MISURA	Ø TUBO x L mm	A	B	C	D	E	F	G	H	L			
96163400	G 1"	26 x 250	68	57	102	35	35	26	G 1"	85	342	188	1	10
96164200	G 1 1/4	32 x 250	63	87	132	39	44	32	G 1 1/4	85	342	228	1	10

**SIF 010**

Sifone colonna per lavabo in ABS cromato senza piletta, ispezionabile, con rosone in ABS cromato.

CODICE	MISURA	Ø TUBO x L mm	A	B	C	D	E	F	G	H	L			
96203400	G 1"	26 x 250	67	63	92	35	35	26	G 1"	85	345	174	1	10
96204200	G 1 1/4	32 x 250	80	70	110	39	44	32	G 1 1/4	85	350	236	1	10

* Sifone conforme a quanto richiesto dallo standard EN 274 con colonna d'acqua > 50 mm



SIFONI

7.4 / SERIE 50th

SERIE 50th

SIFONI D'ARREDO



CARATTERISTICHE COSTRUTTIVE

I sifoni d'arredo Serie 50th sono dei prodotti d'eccellenza Made in Italy e si distinguono per il design, per le finiture superficiali altissimo livello e per le caratteristiche tecniche che li rendono conformi a quanto previsto dalla norma UNI EN274. In particolare soddisfano il requisito dimensionale relativo alla colonna d'acqua che non deve essere inferiore ai 50 mm.

CROMATURA A TELAIO

I sifoni vengono lucidati finemente a mano e la cromatura viene eseguita a telaio garantendo maggiori spessori di ricopertura e di conseguenza una maggiore resistenza all'invecchiamento e alla corrosione, nonché una finitura estetica di livello pregiato. Tale cromatura viene realizzata utilizzando sostanze e processi galvanici conformi alle più rigide normative internazionali in materia di sanità e di sicurezza ambientale.

CORPO

Il corpo del sifone viene realizzato utilizzando ottone CW617N a basso contenuto di piombo in conformità alla normativa Europea UNI EN12165 a garanzia di un prodotto igienicamente sicuro ed affidabile. Le ghiera di serraggio e il tappo d'ispezione sono in ottone CW614N a basso contenuto di piombo in conformità alla normativa Europea UNI EN12164 che ne stabilisce le caratteristiche di composizione chimica.

DOPPIA TENUTA O-RING

Caratteristica peculiare ed esclusiva dei sifoni d'arredo Prestige è la doppia tenuta o-ring in EPDM e il canotto sfilabile. Questo sistema consente di collegare il sifone alla piletta di scarico e permette agli installatori di tagliare comodamente in un secondo momento il canotto, senza rovinare il corpo del sifone ed evitando di scartare l'intero sifone per un errore di taglio del tubo di scarico. Questa soluzione tecnica fa del sifone d'arredo Luxor Spa un sicuro punto di riferimento per ogni tipo di esigenza estetica, funzionale e di installazione.

TAPPO DI ISPEZIONE

L'apposito tappo di ispezione in ottone è dotato di un comodo intaglio per facilitare le operazioni di apertura/chiusura e per semplificare la periodica pulizia del sifone. Non sono necessari particolari attrezzi di lavoro per eseguire l'ispezione del sifone, basta una semplice moneta.

ROSONE DI COPERTURA

Il rosone di copertura scarico è realizzato in ottone. E' resistente all'usura e alla corrosione del tempo e viene anch'esso lucidato e cromato a telaio con finitura di ottimo pregio.

CARATTERISTICHE TECNICHE



Materiale corpo sifone

CW 617 N - DW UNI-EN 12165:2016



Materiale rosone

CW 508L



Materiale codolo e canotto

CW 508L



Finitura

Cromata

CAMPI DI APPLICAZIONE



lavabi



lavabo cucina





CHROME

BLACK



SIF 011

Sifone d'arredo classico in ottone con finitura cromata o nera, senza piletta, ispezionabile, con canotti, rosone e ghiera in ottone.

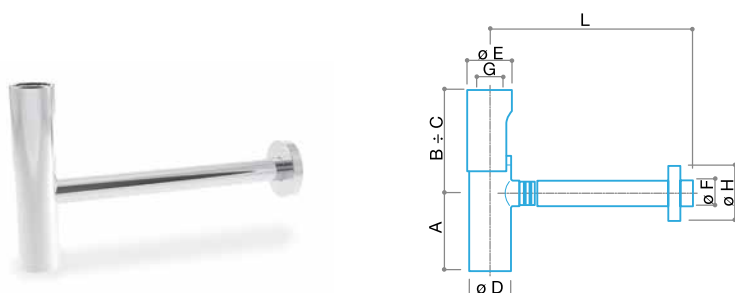
	CODICE	MISURA	Ø TUBO x L mm	FINITURA	A	B	C	D	E	F	G	H	L			
**	93654200	G 1"1/4	32 x 320	CHROME	95	58	128	52	52	32	G 1"1/4	68	356	950	1	5
**	93654200N	G 1"1/4	32 x 320	BLACK	95	58	128	52	52	32	G 1"1/4	68	356	950	1	5



**SIF 012**

Sifone d'arredo a scomparsa in ottone cromato senza piletta, ispezionabile, con canotti, rosone, ghiera e guscio in ottone cromato.

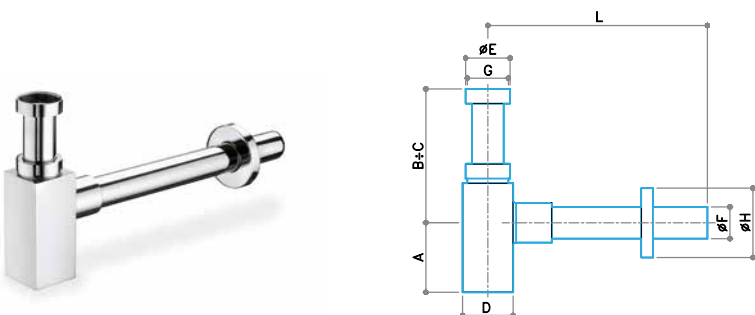
	CODICE	MISURA	Ø TUBO x L mm	A	B	C	D	E	F	G	H	L			
**	93664200	G 1"1/4	32 x 320	95	58	128	52	55	32	G 1"1/4	68	356	1.060	1	5



**SIF 013**

Sifone d'arredo quadrato in ottone cromato senza piletta, ispezionabile, con canotti, rosone e ghiera in ottone cromato.

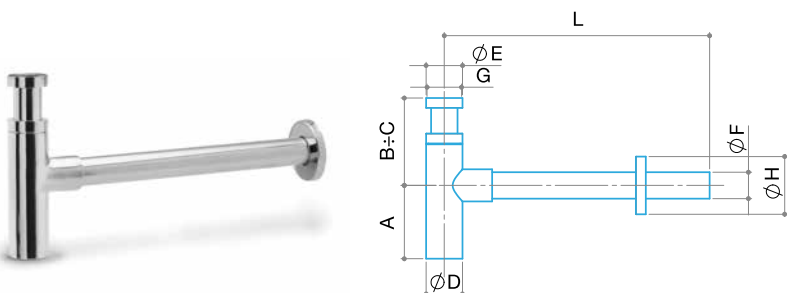
	CODICE	MISURA	Ø TUBO x L mm	A	B	C	D	E	F	G	H	L			
	93634200	G 1" 1/4	32 x 300	70	80	180	50	44	32	G 1"1/4	70	325	890	1	5

**SIF 014**



Sifone d'arredo tondo in ottone cromato senza piletta, ispezionabile, con canotti, rosone, ghiera in ottone cromato.

	CODICE	MISURA	Ø TUBO x L mm	A	B	C	D	E	F	G	H	L			
	93624200	G 1" 1/4	32 x 300	89	75	175	44	44	32	G 1"1/4	70	322	680	1	5

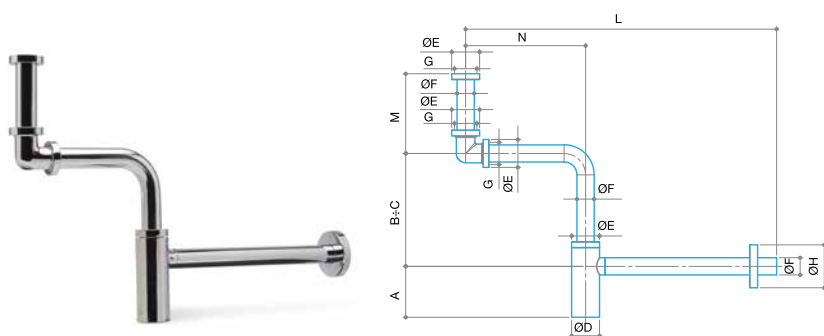
** Sifone conforme a quanto richiesto dallo standard EN 274 con colonna d'acqua > 50 mm

**SIF 015**

Sifone d'arredo salvaspazio in ottone cromato senza piletta, ispezionabile, con canotti, curve, rosone e ghiere in ottone cromato.

CODICE	MISURA	Ø TUBO x L mm	A	B	C	D	E	F	G	H	L	M	N		
93674200	G 1" 1/4	32 x 320	95	175	245	52	52	32	G 1"1/4	80	580	140	223	1440	1



SIFONI

7.5 / SERIE K

SERIE K

SIFONI PER ELETTRODOMESTICI



CAMPI DI APPLICAZIONE



lavatrici

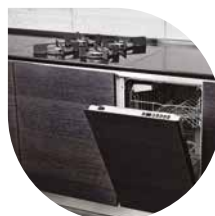

lavastoviglie

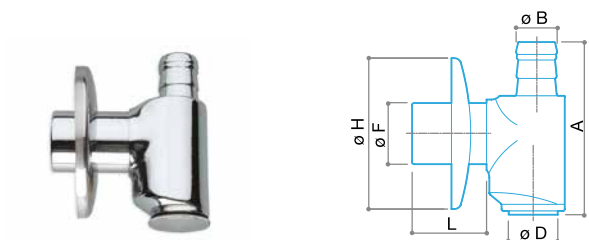

SIF 019

Sifone scarico elettrodomestici in ottone cromato da esterno, ispezionabile per scarico lavatrice e lavastoviglie.

CODICE	MISURA	A	B	C	D	E	F	G	H	L			
93733400	32 x 40	92	22	-	30	-	32	-	80	40	360	2	20

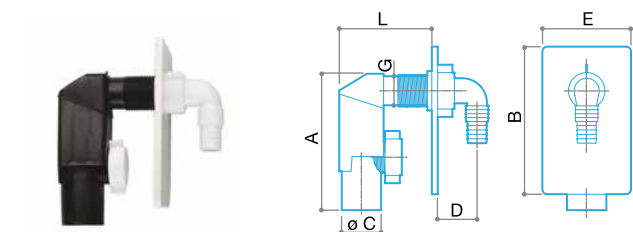

SIF 020

Sifone scarico elettrodomestici in plastica bianca da incasso, ispezionabile per scarico lavatrice e lavastoviglie.

CODICE	MISURA	A	B	C	D	E	F	G	H	L			
96264800	40	139	150	40	40	90	-	G 1"	-	94	176	1	50



SIFONI

7.6 / TUBI DI SCARICO E ACCESSORI

TUBI DI SCARICO E ACCESSORI



CARATTERISTICHE COSTRUTTIVE

I tubi scarico sono realizzati in ottone CW508L a basso contenuto di piombo in conformità alla norma UNI EN12449.

GAMMA

La gamma è composta da tubi lisci, tubi con flangia, tubi con curva, adattatori e prolunghe cromati a telaio per garantire una maggiore resistenza all'invecchiamento e alla corrosione.

Tale cromatura viene realizzata utilizzando sostanze e processi galvanici conformi alle più rigide normative internazionali in materia di sanità e di sicurezza ambientale.





ROSONI

I rosoni, lucidati e cromati, sono realizzati sia in acciaio inox AISI 430 che in ottone e sono in grado di resistere all'azione degli agenti atmosferici e all'ossidazione che si potrebbe formare durante il normale utilizzo.







TUBO LISCIO

Tubo di scarico in ottone cromato.

CODICE	MISURA	A	B	C	D	E	F	G	H	L				
35012620	Ø 26	26	-	-	-	-	-	-	-	200	52	-	10	80
35012625		26	-	-	-	-	-	-	-	250	60	-	10	80
35012630		26	-	-	-	-	-	-	-	300	72	-	10	80
35012699		26	-	-	-	-	-	-	-	1000	248	5	-	-
35013020	Ø 30	30	-	-	-	-	-	-	-	200	56	-	10	80
35013025		30	-	-	-	-	-	-	-	250	68	-	10	80
35013030		30	-	-	-	-	-	-	-	300	86	-	10	80
35013099		30	-	-	-	-	-	-	-	1000	290	5	-	-
35013220	Ø 32	32	-	-	-	-	-	-	-	200	64	-	10	80
35013225		32	-	-	-	-	-	-	-	250	72	-	10	80
35013230		32	-	-	-	-	-	-	-	300	88	-	10	80
35013250		32	-	-	-	-	-	-	-	500	148	5	-	-
35013299		32	-	-	-	-	-	-	-	1000	300	5	-	-
35014020	Ø 40	40	-	-	-	-	-	-	-	200	80	-	5	-
35014025		40	-	-	-	-	-	-	-	250	116	-	5	-
35014030		40	-	-	-	-	-	-	-	300	134	-	5	-
35014099		40	-	-	-	-	-	-	-	1000	464	1	-	-

**TUBO CON FLANGIA**

Tubo di scarico in ottone cromato con flangia ricavata.

CODICE	MISURA	A	B	C	D	E	F	G	H	L				
35022620	Ø 26	26	30	-	-	-	-	-	-	200	52	-	10	80
35022625		26	30	-	-	-	-	-	-	250	62	-	10	80
35022630		26	30	-	-	-	-	-	-	300	74	-	10	80





35023020	Ø 30	30	38	-	-	-	-	-	-	200	52	-	10	80
35023025		30	38	-	-	-	-	-	-	250	72	-	10	80
35023030		30	38	-	-	-	-	-	-	300	84	-	10	80

35023220	Ø 32	32	38	-	-	-	-	-	-	200	58	-	10	80
35023225		32	38	-	-	-	-	-	-	250	74	-	10	80
35023230		32	38	-	-	-	-	-	-	300	86	-	10	80

35024020	Ø 40	40	44	-	-	-	-	-	-	200	114	-	5	-
35024025		40	44	-	-	-	-	-	-	250	122	-	5	-
35024030		40	44	-	-	-	-	-	-	300	130	-	5	-

**TUBO CON CURVA 90°**





Tubo di scarico in ottone cromato con curva 90°.

CODICE	MISURA	A	B	C	D	E	F	G	H	L				
35050400	Ø 30	30	-	-	-	-	-	-	150	250	119	5	-	35
35050200		30	-	-	-	-	-	-	200	300	164	5	-	25

35050600	Ø 32	32	-	-	-	-	-	-	200	250	230	5	-	25
----------	------	----	---	---	---	---	---	---	-----	-----	-----	---	---	----



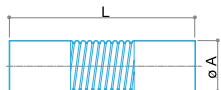

**TUBO CON CURVA 45°**

Tubo di scarico in ottone cromato con curva 45°.

CODICE	MISURA	A	B	C	D	E	F	G	H	L				
35060225	Ø 30	30	-	-	-	-	-	-	75	250	102	5	-	50



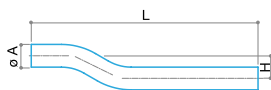

**TUBO PIEGHEVOLE OTTONE**

Tubo di scarico in ottone cromato pieghevole.

CODICE	MISURA	A	B	C	D	E	F	G	H	L				
35032625	Ø 26	26	-	-	-	-	-	-	-	250	66	-	10	-
35032630		26	-	-	-	-	-	-	-	300	86	-	10	-
35033025	Ø 30	30	-	-	-	-	-	-	-	250	86	-	10	-
35033030		30	-	-	-	-	-	-	-	300	102	-	10	-
35033225	Ø 32	32	-	-	-	-	-	-	-	250	94	-	10	-
35033230		32	-	-	-	-	-	-	-	300	99	-	10	-



**TUBO ECCENTRICO**

Tubo di scarico in ottone cromato eccentrico.

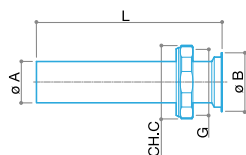
CODICE	MISURA	A	B	C	D	E	F	G	H	L				
35152630	Ø 26	26	-	-	-	-	-	-	30	300	150	-	10	-
35153030	Ø 30	30	-	-	-	-	-	-	30	300	164	-	10	-
35153230	Ø 32	32	-	-	-	-	-	-	30	300	178	-	10	-

**TUBO CON DADO**

Tubo di scarico in ottone cromato con flangia ricavata e dado.

CODICE	MISURA	A	B	C	D	E	F	G	H	L				
35042620	Ø 26	26	37	44	-	-	-	G 1"1/4	-	200	86	-	10	-

**PROLUNGA**

Prolunga in ottone cromata con o-ring.

CODICE	MISURA	A	B	C	D	E	F	G	H	L				
35160026	Ø 26	26	28	33	60	-	-	-	-	130	32	-	10	-
35160030	Ø 30	30	32	37	60	-	-	-	-	130	35	-	10	-
35160032	Ø 32	32	33	41	60	-	-	-	-	130	38	-	10	-
35160040	Ø 40	40	42	51	60	-	-	-	-	130	68	-	5	-

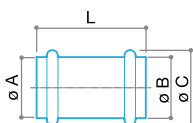
**GIUNTO**

Giunto intermedio in ottone cromato con o-ring.

CODICE	MISURA	A	B	C	D	E	F	G	H	L				
35161026	Ø 26	26	28	33	-	-	-	-	-	55	22	-	10	-
35161030	Ø 30	30	32	37	-	-	-	-	-	55	28	-	10	-
35161032	Ø 32	32	33	41	-	-	-	-	-	60	34	-	10	-
35161040	Ø 40	40	42	51	-	-	-	-	-	70	53	-	5	-

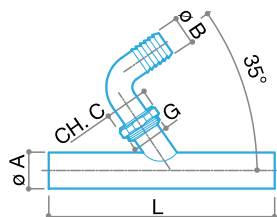

TUBO SCARICO ELETTRDOMESTICI

Tubo di scarico in ottone cromato con curva in ABS cromata per scarico lavatrice e lavastoviglie.

CODICE	MISURA	A	B	C	D	E	F	G	H	L				
35200026	Ø 26	26	25	36	-	-	-	G 1"	-	200	138	-	5	-
35200032	Ø 32	32	25	36	-	-	-	G 1"	-	200	142	-	5	-

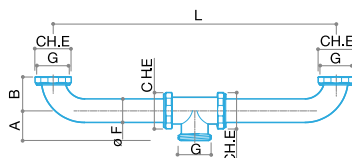

RACCORDO A DUE VIE

Raccordo in ottone cromato senza piletta per sifoni.

CODICE	MISURA	A	B	C	D	E	F	G	H	L				
93504200	G 1"1/4	38	43	-	-	44	30	G 1"1/4	-	360	418	1	10	-



DADI

Dadi in ottone cromato per sifoni.

CODICE	MISURA	Ø TUBO mm			
97222600CF	G 1"	26	20	25	-
97223200CF	G 1"1/4	32	24	25	-



RIDUZIONI

Riduzioni in ottone cromato per adattare la piletta a sifoni di misura diversa.

CODICE	F	M			
94164200	G 1"1/4	G 1"	80	25	-
94164800	G 1"1/2	G 1"1/4	112	20	-



GUARNIZIONE CONICA SIFONE

Guarnizione conica in gomma nera.

CODICE	MISURA	Ø TUBO mm			
97172600CF	G 1"	26	1	100	-
97173000CF	G 1"1/4	30	1	100	-
97173200CF	G 1"1/4	32	1	100	-
97174000CF	G 1"1/2	40	1	100	-



GUARNIZIONE CONICA SCARICO

Guarnizione conica in gomma nera per adattare tubo di scarico.

CODICE	MISURA	Ø TUBO mm			
60294032CF	40 x 32 G 1"1/4 G 1"1/2	-	6	50	-

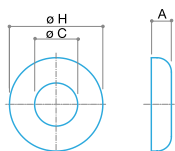
**ROSONE ϕ 65 mm**

Rosone scorrevole in acciaio inox ϕ 65 mm con foro rotondo.

CODICE	MISURA	A	B	C	D	E	F	G	H	L				
30100026CF	ϕ 65	14	-	26	-	-	-	-	65	-	12	-	50	-
30100030CF		14	-	30	-	-	-	-	65	-	12	-	50	-
30100032CF		14	-	32	-	-	-	-	65	-	12	-	50	-

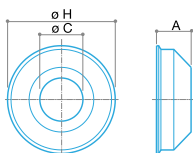
**ROSONE SAGOMATO ϕ 75 mm**

Rosone sagomato scorrevole in acciaio inox ϕ 75 mm con foro rotondo.

CODICE	MISURA	A	B	C	D	E	F	G	H	L				
30090126CF	ϕ 75	24	-	26	-	-	-	-	75	-	20	-	25	-
30090130CF		24	-	30	-	-	-	-	75	-	20	-	25	-
30090132CF		24	-	32	-	-	-	-	75	-	20	-	25	-

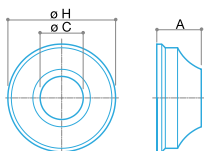

**ROSONE SAGOMATO ϕ 75 mm**

Rosone sagomato scorrevole in ottone cromato ϕ 75 mm con foro rotondo.

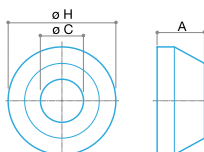
CODICE	MISURA	A	B	C	D	E	F	G	H	L				
30090026CF	ϕ 75	31	-	26	-	-	-	-	75	-	16	50	-	-
30090030CF		31	-	30	-	-	-	-	75	-	14	50	-	-
30090032CF		31	-	32	-	-	-	-	75	-	14	50	-	-



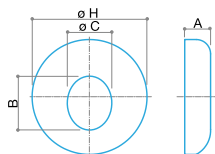

**ROSONE CONICO ϕ 75 mm**

Rosone conico scorrevole in ottone cromato ϕ 75 mm con foro rotondo.

CODICE	MISURA	A	B	C	D	E	F	G	H	L				
30070026CF	ϕ 75	33	-	26	-	-	-	-	75	-	24	25	-	-
30070030CF		33	-	30	-	-	-	-	75	-	24	25	-	-
30070032CF		33	-	32	-	-	-	-	75	-	24	25	-	-
30070040CF		33	-	40	-	-	-	-	75	-	24	25	-	-

**ROSONE FORO OVALE**

Rosone scorrevole in ottone cromato con foro ovale.

CODICE	MISURA	A	B	C	D	E	F	G	H	L				
30110030CF	ϕ 80	18	38	31	-	-	-	-	80	-	22	25	-	-
30110230CF	ϕ 110	31	38	31	-	-	-	-	110	-	64	5	-	-

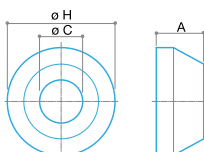

**ROSONE CONICO ϕ 100 mm**

Rosone conico gigante scorrevole in ottone cromato ϕ 100 mm adatto per tubo eccentrico.

CODICE	MISURA	A	B	C	D	E	F	G	H	L				
35120026	ϕ 100	43	-	26	-	-	-	-	100	-	58	10	-	-
35120030		43	-	30	-	-	-	-	100	-	56	10	-	-
35120032		43	-	32	-	-	-	-	100	-	56	10	-	-



**MANICOTTO DIRITTO**

Manicotto in gomma bianca per braga w.c.

CODICE	MISURA	Ø TUBO mm			
60295000	Ø 100	-	179	1	-

**MANICOTTO ECCENTRICO**

Manicotto in gomma bianca per braga w.c.

CODICE	MISURA	Ø TUBO mm			
60295100	Ø 100	-	182	1	-



**MORSETTO UNIVERSALE**

Morsetto di riduzione in gomma per tubi di scarico.

CODICE	MISURA	Ø TUBO mm			
60291000	40	26-30-32	14	25	-
60291100	50	26-30-32	26	25	-
60291200	50	40	22	25	-



**MORSETTO STANDARD**

Morsetto di riduzione in gomma per tubi di scarico.

CODICE	MISURA	Ø TUBO mm			
60291300	47	26-30-32	22	25	-
60291400		40	12	25	-



**MORSETTO UNIVERSALE WC**

Morsetto di riduzione in gomma per w.c.

CODICE	MISURA	Ø TUBO mm			
60290200	50	30-32	28	50	-

**MORSETTO UNIVERSALE WC**

Morsetto di riduzione in gomma per w.c.

CODICE	MISURA	Ø TUBO mm			
60300000	60	30-32	34	50	-



8 / ACCESSORI

ACCESSORI



CARATTERISTICHE COSTRUTTIVE

La gamma delle pilette Luxor Spa comprende una varietà di articoli utilizzabili per lo scarico di lavabo, vasche, piatti doccia, scarichi a pavimento, sistemi di drenaggio, ecc.

Le pilette sono realizzate in ottone CW617N a basso contenuto di piombo conforme alla normativa UNI EN12165 e in acciaio inox AISI 304 con ottime proprietà fisiche di resistenza all'ossidazione.

Per offrire una completa gamma di prodotti ai propri clienti Luxor Spa propone articoli di complemento ed accessori per i più comuni collegamenti sanitari.

I nipples sono realizzati in acciaio con trattamento superficiale di zincatura anticorrosione.

FINITURA CROMATA

I prodotti in ottone cromato CW617N e CW614N sono a basso contenuto di piombo in conformità alle più recenti normative UNI EN12165 e UNI EN12164. La loro finitura cromata garantisce esistenza alla invecchiamento e alla corrosione, nonché una finitura estetica di ottimo livello.

Tale cromatura viene realizzata utilizzando sostanze e processi galvanici conformi alle più rigide normative internazionali in materia di sanità e di sicurezza ambientale.

Le guarnizioni piane sono realizzate in EPDM perossidico e in Fasit, materiali atossici e idonei per l'adduzione di acqua potabile.





PILETTE



PILETTA SENZA TROPPO PIENO



Piletta in ottone cromato con tappo, catena ed anello.

CODICE	MISURA	Ø TESTA x L mm			
94043401	G 1"	63 x 70	163	10	80
94044201	G 1 1/4"	63 x 70	212	10	80



PILETTA CON TROPPO PIENO



Piletta in ottone cromato con tappo, catena, anello, senza codolo.

CODICE	MISURA	Ø TESTA x L mm			
94043400	G 1"	63 x 70	172	10	80
94044200	G 1 1/4"	63 x 70	186	10	80



PILETTA GATTINARA



Piletta in ottone con griglia in acciaio inox, tappo, catena ed anello.

CODICE	MISURA	Ø TESTA mm			
94134200	G 1 1/4"	80	202	10	80



PILETTA GATTINARA



Piletta in ottone con griglia in acciaio inox e tappo a maniglia.

CODICE	MISURA	Ø TESTA mm			
94134201	G 1 1/4"	80	184	10	80



PILETTA STOP & GO SENZA TROPPO PIENO



Piletta per lavabo automatica in ottone cromato.

CODICE	MISURA	Ø TESTA x L mm			
94084200	G 1 1/4"	65 x 60	300	10	80



PILETTA STOP & GO CON TROPPO PIENO



Piletta per lavabo automatica in ottone cromato.

CODICE	MISURA	Ø TESTA x L mm			
94084201	G 1 1/4"	65 x 60	305	10	80



PILETTONE SIFOIDE SENZA TROPPO PIENO



Pilettoni in ottone cromato per lavello in ceramica e vasca in cemento con tappo a maniglia, senza codolo.

CODICE	MISURA	Ø TESTA mm			
94234202	G 1 1/4"	80	440	5	40



PILETTONE SIFOIDE CON TROPPO PIENO



Pilettoni in ottone cromato per livello in ceramica e vasca in cemento con tappo a maniglia, senza codolo.

CODICE	MISURA	Ø TESTA mm			
94234201	G 1"1/4	80	440	5	40



VITE CON ROSETTA



Vite con rosetta e triangolo per tappo con catena.

CODICE	MISURA	Ø ROSETTA mm			
60392000	-	40	18	25	-



TAPPI CON CATENA

Tappo in PVC nera con catena ed anello.

CODICE	MISURA	Ø TESTA mm			
60390031	Ø 31	-	14	25	-
60390040	Ø 40	-	24	25	-
60390052	Ø 52	-	27	25	-



TAPPI A MANIGLIA



Tappo in PVC nera a maniglia.

CODICE	MISURA	Ø TESTA mm			
60391052	Ø 52	-	22	25	-



PILETTA DOCCIA



Piletta in ottone con griglia in acciaio inox, senza codolo.

CODICE	MISURA	Ø TESTA mm			
94314201	G 1"1/4	80	172	10	80
94314801	G 1"1/2	80	158	10	80



PILETTA SIFOIDE DOCCIA



Piletta in ottone con griglia in ottone cromato, senza codolo.

CODICE	MISURA	Ø TESTA mm			
94334201	G 1"1/4	75	304	5	40



PILETTA SIFOIDE DOCCIA

Piletta in ottone a pozzetto con flangia e griglia in ottone cromato.

CODICE	MISURA	Ø TESTA x H mm			
94368001	G 1"1/4	80 x 85	840	2	16

ACCESSORI



POZZETTO SIFOIDE PER PAVIMENTO

Pozzetto in ottone cromato con scarico verticale filettato.

CODICE	MISURA	QUADRO mm			
95089999	G 1"1/4	100 x 100	626	2	-



POZZETTO SIFOIDE PER PAVIMENTO



Pozzetto in ottone cromato con scarico laterale filettato.

CODICE	MISURA	QUADRO mm			
95069999	G 1"1/4	100 x 100	824	2	-



GRIGLIA PIATTO DOCCIA



Griglia in ottone cromato per piletta sifoide doccia per cod. 94334201.

CODICE	MISURA	Ø GRIGLIA mm			
97184200	-	60	66	10	-



GRIGLIA PIATTO DOCCIA



Griglia in ottone cromato per pozzetto piatto doccia, per cod. 94368001.

CODICE	MISURA	Ø GRIGLIA mm			
97204200	-	45	38	10	-



GRIGLIA PER POZZETTO PAVIMENTO



Griglia in ottone cromato per pozzetto pavimento, per cod. 95089999 - 95069999.

CODICE	MISURA	Ø GRIGLIA mm			
97184201	-	90	164	2	-



GRIGLIA A CAMPANA



Griglia in acciaio inox per piletta sifoide.

CODICE	MISURA	Ø GRIGLIA mm			
97194200	-	45	34	10	-



COLONNA VASCA



Colonna automatica scarico vasca in ottone.

CODICE	MISURA	Ø GRIGLIA mm			
94484800	G 1"1/2	-	1030	1	20



CODOLO CURVO IN PEHD



Codoli curvi in PEHD con dado in ottone e guarnizione.

CODICE	MISURA	Ø TUBO mm			
94574201	G 1"1/4	40	82	10	-
94574801	G 1"1/2	40	100	10	-



CODOLO DIRITTO



Codoli dritti in ottone con dado e guarnizione.

CODICE	MISURA	Ø TUBO mm			
94583400	G 1"	26	46	10	-
94584200	G 1"1/4	32	62	10	-



CODOLO DIRITTO IN PEHD

Codoli dritti in PEHD con dado in ottone e guarnizione.



CODICE	MISURA	Ø TUBO mm			
94584201	G 1"1/4	40	72	10	-
94584801	G 1"1/2	40	84	10	-

NIPPLO



NIPPLO SEDE PIANA-CONICA



Raccordo in acciaio zincato
Maschio-Maschio con sede piana
per collegamento antivibranti.
ARTICOLO IN ESAURIMENTO.

CODICE	MISURA			
27302100	G 1/2 x G 1/2	42	-	30
27306000	G 2" x G 2"	402	-	5



NIPPLO SEDE PIANA-PIANA

Raccordo in acciaio zincato
Maschio-Maschio.

CODICE	MISURA			
50081010CF	G 1/8 x G 1/8	10	10	100
50081013CF	G 1/8 x G 1/4	12	10	100
50081313CF	G 1/4 x G 1/4	12	10	50
50081317CF	G 1/4 x G 3/8	14	10	50
50081717CF	G 3/8 x G 3/8	20	10	50
50081721CF	G 3/8 x G 1/2	28	10	50
50081727CF	G 3/8 x G 3/4	52	10	50
50081734CF	G 3/8 x G 1"	74	10	50
50082121CF	G 1/2 x G 1/2	44	10	50
50082127CF	G 1/2 x G 3/4	58	10	50
50082134CF	G 1/2 x G 1"	76	10	50
50082727CF	G 3/4 x G 3/4	46	10	20
50082734CF	G 3/4 x G 1"	78	10	20
50083434CF	G 1" x G 1"	78	10	20



TAPPI COLLAUDO

Tappo per collaudo in plastica rossa o
blu per prova impianti.

CODICE	MISURA			
50112101CF-BLU	G 1/2	16	-	50
50112102CF-ROSSO		16	-	50



GUARNIZIONE IN FASIT

Guarnizione sanitarie in fasit.

CODICE	MISURA			
60171700CF	G 3/8	1	100	-
60172100CF	G 1/2	1	100	-
60172700CF	G 3/4	1	100	-
60173400CF	G 1"	1	100	-
60174200CF	G 1"1/4	1	100	-
60174800CF	G 1"1/2	1	100	-
60176000CF	G 2"	2	100	-

ARTICOLO	PAG.	ARTICOLO	PAG.	ARTICOLO	PAG.
SIF 1	495	V 43	467	TP 99/C	314
S 2	463	V 46	468	CD 100	153
SIF 2	495	V 47	468	RD 101	10
S 3	463	S 53	473	CD 101	153
SIF 3	495	S 54	473	RS 102	10
SIF 4	496	KT 58/A	67	RD 105	11
SIF 5	499	RD 58/A	70	RS 106	11
SIF 6	499	KT 59/A	65	CH 110	323
S 7	463	RS 59/A	70	RD 111	12
SIF 7	499	S 60	477	RD 111/A	14
S 8	463	S 61	477	CH 111	107
SIF 8	503	S 62	477	RS 112	12
SIF 9	503	S 63	477	RS 112/A	14
SIF 10	503	KT 69/A	66	CH 112	107
SIF 11	507	RCD 69/A	71	RD 118	13
S 12	463	S 70	481	RD 118/A	15
SIF 12	507	S 71	481	RS 119	13
SIF 13	507	S 72	481	RS 119/A	15
SIF 14	507	KT 73/A	66	DD 121	10
SIF 15	508	RCS 73/A	72	DS 122	10
SIF 17	496	S 73	481	DD 125	11
SIF 18	496	S 74	481	DS 126	11
S 19	457	S 75	482	DD 131	12
SIF 19	510	S 76	482	DD 131/A	14
S 20	457	S 77	482	DS 132	12
SIF 20	510	DD 78/A	71	DS 132/A	14
DD 21	29	S 78	482	DD 138	13
DS 22	29	DS 79/A	70	DD 138/A	15
S 23	457	S 79	482	DS 139	13
S 24	457	M 81	81	DS 139/A	15
DD 25	29	M 83	82	KT 146	53
DS 26	29	M 85	82	KT 159/A	53
S 27	458	M 86	81	M 171	101
DCD 29/A	72	M 87	81	M 172	102
S 30	458	M 88	81	M 173	101
DD 31	32	DS 89/A	54	M 174	102
DD 31/A	35	TP 90	313	M 175	101
S 31	458	TR 91	311	M 176	102
DS 32	32	TR 91/A	311	M 177	101
DS 32/A	35	TR 91/AC	314	M 178	102
DCS 33/A	71	TR 92	311	KT 201	24
V 35	467	TP 93	312	RD 201	27
V 36	468	TR 94	311	KT 202	24
DD 38	32	TP 95	312	RS 202	27
DD 38/A	35	TP 96	313	KT 205	24
DS 39	32	TP 97	313	RD 205	27
DS 39/A	35	TP 98	312	KT 206	24
V 39	467	TP 98/C	314	RS 206	27
V 40	467	TP 99	313	KT 208	25

ARTICOLO	PAG.	ARTICOLO	PAG.	ARTICOLO	PAG.			
KT	208/A	26	M	361	94	CD	457	142
RD	208	30	M	361/A	95	RD	458	195
RD	208/A	33	M	371	94	CD	459	143
KT	209	25	M	371/A	95	CD	460	144
KT	209/A	26	CP	402	113	TC	460	185
RS	209	30	CP	403	113	TC	460	191
RS	209/A	33	CP	404	113	TC	460	304
KT	211	25	CP	412	114	CD	461	143
KT	211/A	26	CP	413	114	CP	462	122
RD	211	30	CC	413	133	CP	462/FR	129
RD	211/A	33	CP	414	114	CD	462	144
KT	212	25	CC	414	133	TC	462	191
KT	212/A	26	CC	415	133	TC	462	304
RS	212	30	CC	416	133	CP	463	122
RS	212/A	33	CP	422	115	CP	463/FR	129
BT	242	40	CP	423	115	CP	464	122
DT	242	190	CP	424	115	CP	464/FR	129
TM	245	107	TC	430	191	TC	464	192
KT	258/A	62	CP	432	120	CD	465	158
RD	258/A	67	CP	432/FR	127	TC	465	192
KT	259/A	62	CP	433	120	CD	465M	164
RS	259/A	67	CP	433/FR	127	CD	466	147
KT	269/A	62	CP	434	120	CD	467	159
RCD	269/A	68	CP	434/FR	127	CD	468	158
KT	273/A	63	TC	435	192	CD	468M	164
RCS	273/A	68	IU	436	123	CD	469	159
MT	282	85	IU	437	123	VS	470	214
M	300	88	TC	440	192	VC	471	212
M	320	88	CP	442	116	VC	471/A	212
M	320/A	89	CP	443	116	VC	472	213
MD	321/A	36	CP	444	116	CD	473	162
MS	321/A	36	TC	445	192	CD	473M	165
MD	321/A	99	CD	446	147	CD	474	151
MS	321/A	99	RE	447	304	CD	474/1	194
M	322	89	CD	448	149	CT	474	205
M	330	31	CD	448/1	193	VC	475	213
M	330/A	34	CD	449	149	VC	476	213
M	330	88	CD	449/1	193	VCS	476	214
M	330/A	89	TC	450	191	VC	476	305
MS	331/A	36	CD	451	141	CD	477	163
MD	331/A	36	CP	452	121	AC	477	205
MS	331/A	99	CP	452/FR	128	CF	477	205
MD	331/A	99	CP	453	121	VCS	477	215
M	332	28	CP	453/FR	128	CD	478	162
M	332	89	CP	454	121	VCS	478	214
M	341	94	CP	454/FR	128	CD	478M	165
M	341/A	95	RD	455	196	CD	479	163
M	351	94	RD	455	304	AC	479	205
M	351/A	95	CD	456	141	CF	479	205

ARTICOLO	PAG.	ARTICOLO	PAG.	ARTICOLO	PAG.
VCS 479	215	513	109	VS 610	220
VCG 480	214	515	107	CH 620	220
RC 480	322	516	200	VS 620	220
VC 481	185	517	106	KC 650	194
VC 481	215	518	106	VM 650	224
RC 481	323	M 520	109	KC 651	194
RD 482	323	M 521	109	KC 652	194
SA 483	198	M 522	109	VM 652	224
SA 483/A	198	M 523	109	KC 653	194
SA 483/B	198	M 524	109	VM 660	223
RD 483	323	M 525	109	VZ 700	227
SD 484	198	M 526	110	SM 700	227
CF 485	206	M 528	108	VZ 702	227
RT 487	197	M 528	318	VZ 712	227
RT 488	197	M 529	106	VB 750	217
TC 488	198	M 530	106	FM 750	245
CT 488	206	M 531	106	VB 751	217
CR 489	195	M 532	110	VB 752	217
RTA 489	197	M 533	110	VB 753	217
CT 489	206	535	108	VB 755	217
AC 489	207	536	108	PCE 755	278
CR 490	195	PS 540	190	PCE 756	278
RTR 490	197	PS 541	275	PCE 757	278
CF 490	206	560	200	TZ 800	278
AC 490	207	563	200	FX 801	345
CR 491	195	567	200	FP 801	349
CF 491	207	570	107	OF 801	353
CR 492	195	571	123	OP 801	363
SA 492	199	572	107	WF 801	379
CF 492	207	574	107	KF 801	393
SA 494	199	576	107	FX 801	397
SC 496	204	578	107	FP 801	401
SC 496/A	204	580	107	EFI 801	405
SC 496/B	204	580	123	FX 802	345
CR 496	305	583	107	FP 802	349
SC 497	204	584	109	OF 802	353
CR 498	106	586	109	OP 802	363
CR 498	196	VS 601	218	WF 802	380
CR 498/A	196	VS 601/S	220	KF 802	393
CR 498/B	196	VS 601/S	257	FX 802	397
CR 499	196	VS 602	218	FP 802	401
500	109	VS 603	219	EFI 802	406
501	200	VS 603/S	220	FX 803	345
505	107	VS 603/S	257	FP 803	349
507	106	VS 604/A	218	OF 803	353
508	106	VS 604/S	219	OP 803	363
508/B	106	VS 604/S	257	KF 803	393
509	106	VS 605	219	FX 803	397
512	109	VS 606	219	FP 803	401

ARTICOLO	PAG.
FX 804	345
FP 804	349
OF 804	353
OP 804	363
FX 804	397
FP 804	401
FX 805	346
OF 805	354
OP 805	364
FX 805	398
OF 806	354
OP 806	364
OF 807	354
OP 807	364
OF 808	355
OP 808	365
OF 809	355
OP 809	365
OF 810	356
OP 810	365
OF 811	356
OP 811	365
OF 812	356
OP 812	366
OF 813	356
OP 813	366
OF 814	357
OP 814	366
OF 815	357
OP 815	366
OF 816	357
OF 817	357
OF 818	358
OF 819	358
OF 820	358
OF 821	358
OF 822	359
OF 823	359
OF 824	359
OF 825	359
CD 860	141
CD 861	142
CD 862	143
CD 863	144
CD 864	143
CD 865	144
CD 867	151
CD 868	151
CD 869	152

ARTICOLO	PAG.
CD 870	152
CD 871	147
CD 872	147
CD 873	148
CD 874	148
CD 875	145
CD 876	145
CD 877	146
CD 878	146
CD 879	149
CD 880	149
CD 881	150
CD 882	150
TR 890	311
RD 900	319
RD 901	193
RD 902	319
RD 903	320
RC 904	320
RC 905	320
RC 906	320
RT 907	321
RT 908	321
RT 909	321
VS 910	221
VS 911	221
RT 911	321
VS 912	222
RC 912	322
VS 913	222
RC 914	318
VS 920	222
RD 923	322
VS 930	222
OF 1001	369
WF 1001	379
EFI 1001	405
EF 1001	409
OF 1002	369
WF 1002	380
EFI 1002	406
EF 1002	409
OF 1003	369
EF 1003	409
OF 1004	369
EF 1004	409
OF 1005	370
OF 1006	370
OF 1007	370

ARTICOLO	PAG.
OF 1008	371
OF 1009	371
OF 1010	372
OF 1011	372
OF 1012	372
OF 1013	372
OF 1014	373
OF 1015	373
OF 1016	373
OF 1017	373
OF 1018	374
OF 1019	374
OF 1020	374
OF 1021	374
OF 1022	375
OF 1023	375
OF 1024	375
OF 1025	375
AC 1180	256
GSP 1180	256
GSP 1182	256
GP 1190	234
KA 1191	239
GM 1192	250
GM 1193	250
CB 1200	250
CB 1205	199
CB 1205	250
CD 1210	294
GR 1220	296
CB 1220	305
CB 1222	305
GR 1230	296
GM 1240	298
GM 1250	298
GM 1260	300
GM 1270	300
CE 1300	279
OF 1301	387
EFI 1301	405
OF 1302	387
EFI 1302	406
OF 1303	387
OF 1304	387
CE 1305	279
OF 1305	388
OF 1306	388
OF 1307	388
OF 1308	389

ARTICOLO	PAG.	ARTICOLO	PAG.	ARTICOLO	PAG.	ARTICOLO	PAG.
OF 1309	389	SS 1984	322	RS 2509/A	34	AC 3209	433
CE 1310	279	GS 1993	318	KT 2509/A	53	CD 3446	146
OF 1310	389	GS 1995	108	RS 2509/A	54	CD 3459	154
OF 1311	390	GS 1995	318	AC 2509	433	CD 3460	155
OF 1312	390	AC 2001	437	AC 2510	437	CD 3461	154
CE 1320	279	DM 2018	229	RD 2511	31	CD 3462	155
SM 1346	282	KT 2058/A	64	RD 2511/A	34	CD 3466	146
SM 1348	282	RD 2058/A	69	RS 2512	31	CD 3474	152
CE 1370	256	KT 2059/A	63	RS 2512/A	34	CD 3862	154
CD 1446	145	RS 2059/A	68	MT 2582	85	CD 3863	155
CD 1446/1	193	KT 2069/A	64	MT 2590/A	72	CD 3864	154
CD 1448	150	RCD 2069/A	69	VT 2600	107	CD 3865	155
CD 1449	150	KT 2073/A	65	CD 2865	156	AC 4001	414
CD 1466	145	RCS 2073/A	69	CD 2867	157	AC 4002	416
CD 1466/1	193	TT 2302	40	CD 2868	156	AC 4003	422
CD 1474	151	CD 2446	148	CD 2869	157	AC 4004	424
CD 1474/1	194	CD 2465	156	CD 2873	160	TM 4005	201
AC 1501	413	CX 2465	180	CD 2877	161	AC 4005	430
AC 1502	415	CX 2465M	182	CD 2878	160	AC 4006	432
AC 1503	417	CD 2466	148	CD 2879	161	TM 4012	199
AC 1504	421	CD 2467	157	TT 3000	40	TM 4014	199
AC 1505	423	CD 2468	156	TT 3000	73	CCBP 4022	234
AC 1506	425	CX 2468	180	TT 3002	40	CCBAP 4023	240
AC 1507	429	CX 2468M	182	TE 3010	267	CCBAP 4024	239
AC 1508	431	CD 2469	157	TE 3011	267	CCBAP 4025	252
AC 1509	433	CD 2473	160	TE 3012	267	CCBP 4026	251
AC 1510	437	CX 2473	181	TE 3013	267	CCBAP 4027	252
AC 1511	437	CX 2473M	183	TE 3020	285	CCBP 4032	235
AC 1801	413	CD 2474	152	TS 3030	274	CCBAP 4033	241
AC 1802	413	CD 2477	161	TS 3032	275	CCBAP 4034	240
AC 1803	415	CD 2478	160	TS 3035	275	CCBAP 4035	253
AC 1804	415	CX 2478	181	TS 3037	274	CCBP 4036	251
AC 1805	417	CX 2478M	183	TS 3050	275	CCBAP 4037	254
AC 1806	417	CD 2479	161	TT 3051	190	CD 4071	250
AC 1807	421	RD 2501	28	TT 3061	190	CD 4072	250
AC 1808	423	AC 2501	413	VA 3090	273	CCBAP 4079	253
AC 1809	425	RS 2502	28	VA 3090S	267	CCBAP 4080	254
AC 1810	429	AC 2502	415	TE 3110	273	AC 5001	414
AC 1811	431	AC 2503	418	TE 3111	273	AC 5002	416
AC 1812	433	AC 2504	421	TE 3112	273	AC 5003	422
CD 1865	158	RD 2505	28	TE 3113	273	AC 5004	424
CD 1867	159	AC 2505	423	AC 3201	414	AC 5005	430
CD 1868	158	RS 2506	28	AC 3202	416	AC 5006	432
CD 1869	159	AC 2506	425	AC 3203	418	VP 5012	278
CD 1873	162	AC 2507	429	AC 3204	422	SF 8506	383
CD 1877	163	RD 2508	31	AC 3205	424	SF 8507	383
CD 1878	162	RD 2508/A	34	AC 3206	425	SF 8508	383
CD 1879	163	AC 2508	431	AC 3207	430		
SS 1982	318	RS 2509	31	AC 3208	432		

CONDIZIONI DI VENDITA

ORDINI

I contratti conclusi dagli agenti o rappresentanti non sono definitivi se non dopo esser stati da noi regolarmente accettati. Tutti gli ordini inviatici dai nostri Agenti e/o Rappresentanti o direttamente, s'intendono emessi con la clausola di accettazione totale e senza riserve di tutte le "Condizioni Generali di Vendita" descritte in questo listino in vigore.

SPEDIZIONI

Le consegne vengono effettuate in porto assegnato salvo speciali accordi contrari. La merce viaggia a rischio e pericolo del compratore anche nel caso di vendita in porto franco.

PAGAMENTI

I termini sono quelli indicati nelle offerte e nelle conferme d'ordine e sono impegnativi. In caso di ritardo di pagamento rispetto alle scadenze pattuite sarà calcolato l'interesse di mora nella misura del tasso unitario medio in atto alla data avvenuta per il pagamento. Il ritardato pagamento di precedenti forniture ci autorizza ad annullare ogni ordine in corso. Gli agenti e rappresentanti non hanno autorità di riscuotere crediti salvo esplicita autorizzazione scritta da parte nostra.

RECLAMI

I reclami concernenti la quantità del materiale spedito sono validi solo se fatti entro 8 giorni dal ricevimento della merce. La ditta non risponderà dei colli mancanti o danneggiati, se non in presenza di "riserva in bolla".

FORO COMPETENTE

Per ogni controversia è riconosciuta la sola competenza del Tribunale di Brescia.

PREZZI

I prezzi non includono l'IVA. I prezzi sono quelli espressamente pattuiti e da noi confermati.

CONSEGNE

I beni in oggetto del presente catalogo saranno consegnati entro un termine non inferiore a 90 giorni dall'accettazione dell'ordine. Qualsiasi termine inferiore ai 90 giorni non si intende accettato dalla parte venditrice salvo conferma scritta.

I termini di consegna sono indicativi e non impegnano la parte venditrice, che non è tenuta a rispondere con indennizzi di sorta per eventuali danni diretti o indiretti dovuti a ritardi di consegna, o ad interruzione o a risoluzione parziale o totale della fornitura.

IMBALLO

I prodotti vengono imballati a cura del venditore.

Tale imballo non prevede prodotti fuori misura o particolari; ove ricorre una qualsiasi di queste ipotesi, le spese sono addebitate al compratore, salvo diverso accordo scritto.

RESI

Non si accetta merce di ritorno senza nostra preventiva autorizzazione scritta ed in ogni caso in porto franco.

MINIMO FATTURABILE

Il venditore oltre alla verifica di fattibilità si riserva la facoltà di evadere solo ordini d'importo superiore a 500 Euro.

GARANZIA

Per le condizioni di garanzia si fa riferimento agli articoli 3 e 5 della Direttiva 1999/44/CE. Un'adeguata polizza assicurativa per la "Responsabilità Civile Prodotti" è a supporto della garanzia.

La garanzia decade se l'installazione ed il collaudo non sono eseguiti a regola d'arte. I grossisti ed i rivenditori sono tenuti a far conoscere ai propri clienti/installatori tutte le avvertenze utili per una corretta installazione dei nostri materiali.

VALIDITÀ DEL CATALOGO

I dati e gli elementi illustrativi pubblicati su questo catalogo s'intendono non impegnativi.

La società LUXOR S.p.A. si riserva il diritto, ferme restando le caratteristiche essenziali dei prodotti descritti, di apportare in ogni momento le eventuali modifiche che ritenesse necessarie o utili per motivi tecnici o commerciali.